

# CORE PROGRAM CONNECTORS

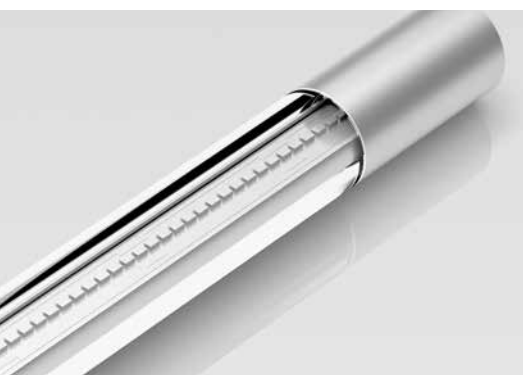





# Product Overview

## Subminiature Connectors

	Series	Page
Snap-in IP40	719 · 709	6
Snap-in IP67	620	8
Bayonet	710	12
Micro Push-Pull	420	14
Push-Pull	430	16
M9 IP40	711	18
M9 IP67	712 · 702	20



## Miniature Connectors

	Series	Page
Snap-in	720	28
Bayonet	678	34
Bayonet NCC	770	38
Push-Pull	440	40
M16 IP40	581 · 680 · 682	44
M16 IP67	423 · 723 · 425	54



## Power Connectors

	Series	Page
M23	623	66
RD24	692 · 693	72
Bayonet HEC	696	80
RD30	694	84



## Connectors for medical applications

	Series	Page
Snap-in ELC	570	86
Snap-in IP67	620	88
Snap-in	720	90
Bayonet NCC	770	92



### Automation Technology – Sensors & Actuators

	Series	Page
M5	707	94
M8	768 - 718	98
M12-A	713 - 763	110
Accessories for M12	M12	141
Connecting Cables	765	146



### Automation Technology – Data Transmission & Power Supply

	Series	Page
M12-B	715 - 766	154
M12-D · M12-X	825 - 876	168
M12-S · M12-K	814	180
M12-T · M12-L	813	186
7/8"	820 - 870	194



### Automation Technology – Solenoid Valve Connectors

	Series	Page
Size A	210	200
Size B	220	205
Size C	230	210



# Contents

Subminiature Connectors	Range	Series	Page	Degree of protection	Voltage	Current	No. of contacts
Page 6–27	Snap-in IP40	<b>719 · 709</b>	<b>6</b>	IP40	60 V	3 A	3–5
	Snap-in IP67	<b>620</b>	<b>8</b>	IP67	63/125 V	1–3 A	3–8
	Bayonet	<b>710</b>	<b>12</b>	IP40	125 V	1–4 A	2–8
	Micro Push-Pull	<b>420</b>	<b>14</b>	IP67	125 V	1 A	3–5
	Push-Pull	<b>430</b>	<b>16</b>	IP67/IP40	125 V	1–4 A	3–8
	M9 IP40	<b>711</b>	<b>18</b>	IP40	125 V	1–4 A	2–8
	M9 IP67	<b>712 · 702</b>	<b>20</b>	IP67	125 V	1–4 A	2–8

## Miniature Connectors

Page 28–65	Snap-in	<b>720</b>	<b>28</b>	IP67	60/250 V	2–7 A	3–12
	Bayonet	<b>678</b>	<b>34</b>	IP40	60/250 V	1–7 A	2–24
	Bayonet NCC	<b>770</b>	<b>38</b>	IP67	175 V	2 A	8
	Push-Pull	<b>440</b>	<b>40</b>	IP67	60/250 V	3–7 A	3–19
	M16 IP40	<b>581 · 680 · 682</b>	<b>44</b>	IP40	60/250 V	1–7 A	2–24
	M16 IP67	<b>423 · 723 · 425</b>	<b>54</b>	IP67	60/250 V	1–7 A	2–24

## Power Connectors

Page 66–85	M23	<b>623</b>	<b>66</b>	IP67	150/300 V	8–20 A	6–19
	RD24	<b>692 · 693</b>	<b>72</b>	IP67	250/400 V	10–16 A	3+PE–6+PE
	Bayonet HEC	<b>696</b>	<b>80</b>	IP68/IP69K	60/600 V	3–32 A	5, 8 (4 + 3+PE), 12
	RD30	<b>694</b>	<b>84</b>	IP65	125/400 V	3–20 A	4+PE–24

## Connectors for medical applications

Page 86–93	Snap-in ELC	<b>570</b>	<b>86</b>	IP67	150 V	2 A	12
	Snap-in IP67	<b>620</b>	<b>88</b>	IP67	125 V	1–3 A	3–8
	Snap-in	<b>720</b>	<b>90</b>	IP67	60/250 V	2–7 A	3–12
	Bayonet NCC	<b>770</b>	<b>92</b>	IP67	175 V	2 A	8

## Automation Technology – Sensors & Actuators

Page 94–153	M5	<b>707</b>	<b>94</b>	IP67	60 V	1 A	3–4
	M8	<b>768 · 718</b>	<b>98</b>	IP65/IP67	30/60 V	1,5–4 A	3–12
	M12-A	<b>713 · 763</b>	<b>110</b>	IP40/IP67/IP68/IP69K	30/250 V	1,5–8 A	3–12
	Accessories for M12	<b>M12</b>	<b>141</b>				
	Connecting Cables	<b>765</b>	<b>146</b>	IP65–IP68	30/250 V	2–4 A	3–5

## Automation Technology – Data Transmission & Power Supply

Page 154–199	M12-B	<b>715 · 766</b>	<b>154</b>	IP67/IP68	125/250 V	1/4 A	2–5
	M12-D · M12-X	<b>825 · 876</b>	<b>168</b>	IP67	50 V AC/60 V DC/250 V	4 A	4, 8
	M12-S · M12-K	<b>814</b>	<b>180</b>	IP67/IP68	630 V	12 A	2–4+PE
	M12-T · M12-L	<b>813</b>	<b>186</b>	IP67/IP68	63 V	12 A/16 A	4, 4+FE
	7/8"	<b>820 · 870</b>	<b>194</b>	IP67	300 V	8–12 A	2+PE–4+PE

## Automation Technology – Solenoid Valve Connectors

Page 200–213	Size A	<b>210</b>	<b>200</b>	IP65/IP67	60/250 V	2–10 A	2–3+PE
	Size B	<b>220</b>	<b>205</b>	IP65/IP67	60/250 V	4–10 A	2+PE
	Size C	<b>230</b>	<b>210</b>	IP65/IP67	60/250 V	4–6 A	2–3+PE

## Index

Page 214–227	Order numbers index	<b>214</b>	
	Cross-reference list	<b>226</b>	

## Technical Information

Page 228–231	Explanations	<b>228</b>	
--------------	--------------	------------	--

EMC	Ø in mm	Termination								moulded connectors	Locking			
		solder	dip solder	SMT	screw	crimp	Wire clamp	IDT	biatec®		screw	Bayonet	snap-in	Push-Pull
—	8–9	•719	•719							•709			•	
—	11,5	•	•							•			•	
—	12	•										•		
—	9,5	•												•
•/—	14,5	•	•											•
—	11,5	•	•								M9 x 0,5			
•/—	11,5–14	•	•							•702	M9 x 0,5			
—	16–19	•	•							•			•	
—	20	•										•		
—	16–23	•	•									•		
•/—	20	•												•
•/—	17–19	•	•		•	•					M16 x 0,75			
•/—	18,5–21,5	•	•		•	•				•425	M16 x 0,75			
•/—	25	•									M23 x 1			
—	29	•			•	•				•692	RD24			
—	36					•						•		
—	40	•				•					RD30			
—	— (21)	•											•	
—	11,5	•	•										•	
—	16–19	•	•										•	
—	16–19	•	•									•		
•/—	6,5		•							•	M5x0,5			
•/—	10–14	•768	•		•768			•768	•768	•718	M8x1		•718	
•	15–20	•763	•763	•763	•713	•713	•713	•713		•763	M12x1			
—	10–15									•	M8/M12			
•	15–20	•	•766	•	•715	•715	•715			•766	M12x1			
•	15–20	•	•	•	•825	•825		•825		•876	M12x1			
—	15–25				•					•	M12x1			
—	15–25	•	•		•					•	M12x1			
—	26–28		•820		•820					•870	7/8"			
—	—	•			•	•				•	M3			
—	—	•			•					•	M3			
—	—	•			•					•	M3			

- Snap-in locking system
- 3 – 5 contacts
- Degree of protection IP40
- Solder termination
- Moulded versions
- Easy assembly



Description	Drawing	Contacts	Cable outlet	Ordering-No.
Male cable connector without strain relief		3		09 9747 00 03
		4	3,6 mm	09 9767 00 04
		5		09 9789 00 05

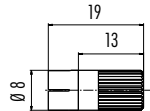

Male cable connector with strain relief		3	2,5–4 mm	09 9747 70 03
			3,5–5 mm	09 9747 71 03
		4	2,5–4 mm	09 9767 70 04
			3,5–5 mm	09 9767 71 04
		5	3,5–5 mm	09 9789 71 05

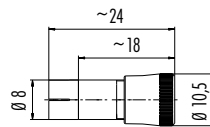

Female cable connector without strain relief		3		09 9748 00 03
		4	3,6 mm	09 9764 00 04
		5		09 9790 00 05

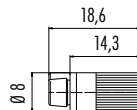

Female cable connector with strain relief		3	2,5–4 mm	09 9748 70 03
			3,5–5 mm	09 9748 71 03
		4	2,5–4 mm	09 9764 70 04
			3,5–5 mm	09 9764 71 04
		5	3,5–5 mm	09 9790 71 05

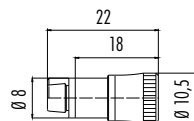

### Specifications

Contacts	3	4	5
Wire gauge	max. 0,25 mm <sup>2</sup> (max. AWG 24)		
Mechanical operation	> 100 Mating cycles		
Temperature range	– 25 °C / + 70 °C		
Rated voltage	60 V		
Pollution degree	1		
Rated current (40°C)	3 A		
Contact plating	Au (Gold)		
Material of housing	PA		



**Description**

**Drawing**

**Contacts Cable length, PVC Ordering-No.**

Male cable connector, moulded

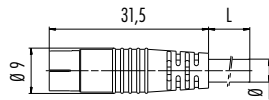

3 x 0,25	2 m	79 9001 12 03
	5 m	79 9001 15 03
4 x 0,25	2 m	79 9003 12 04
	5 m	79 9003 15 04
5 x 0,25	2 m	—
	5 m	79 9005 15 05

Female cable connector, moulded

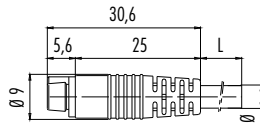

3 x 0,25	2 m	79 9002 12 03
	5 m	79 9002 15 03
4 x 0,25	2 m	79 9004 12 04
	5 m	79 9004 15 04
5 x 0,25	2 m	79 9006 12 05
	5 m	79 9006 15 05

Male panel mount connector, solder termination/dip-solder termination

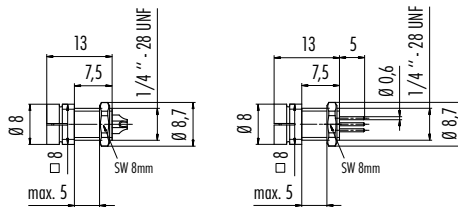

Contacts	Cable length	Solder termination	Dip-Solder termination
3	—	09 9749 30 03	09 9749 20 03
4	—	09 9765 30 04	09 9765 20 04
5	—	09 9791 30 05	09 9791 20 05

Female panel mount connector, solder termination/dip-solder termination

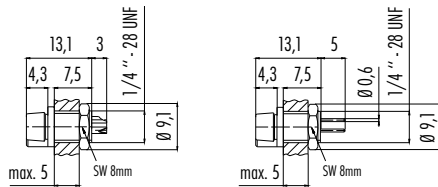

3	—	09 9750 30 03	09 9750 20 03
4	—	09 9766 30 04	09 9766 20 04
5	—	09 9792 30 05	09 9792 20 05

**Component part drawing**

Cable connector without strain relief

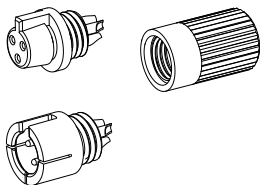

Female insert  
Male insert  
Sleeve

Cable connector with strain relief

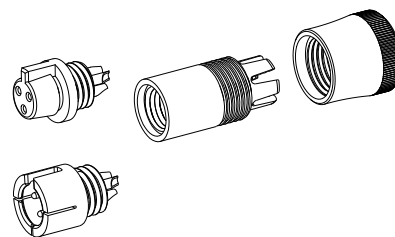

Female insert  
Male insert  
Pinch ring  
Pressing screw

**Contact arrangements male insert (mating side)**

3 contacts      4 contacts      5 contacts

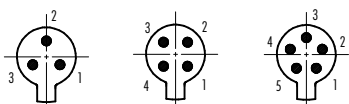

**Contact arrangements female insert (mating side)**

3 contacts      4 contacts      5 contacts

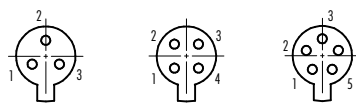

**Panel cut out**



**Colour of wire, moulded cable connectors**

- 1 brown
- 2 white
- 3 blue
- 4 black
- 5 grey

- Snap-in locking system
- 3 – 8 contacts
- Degree of protection IP67
- Solder termination
- Diameter 11,5 mm



Description	Drawing	Contacts	Cable outlet	Black
Male cable connector		3	3–5 mm	99 9205 00 03
		4		99 9209 00 04
		5		99 9213 00 05
		8		99 9225 00 08



Description	Drawing	Contacts	Cable outlet	Black	Red	Blue	Green
Male cable connector, red, blue, green		3	3–5 mm	99 9205 00 03	99 9205 05 03	99 9205 06 03	99 9205 07 03
		4		99 9209 05 04	99 9209 06 04	99 9209 07 04	
		5		99 9213 05 05	99 9213 06 05	99 9213 07 05	
		8		99 9225 05 08	99 9225 06 08	99 9225 07 08	



Description	Drawing	Contacts	Cable outlet	Black
Female cable connector		3	3–5 mm	99 9206 00 03
		4		99 9210 00 04
		5		99 9214 00 05
		8		99 9226 00 08



Description	Drawing	Contacts	Cable outlet	Black	Red	Blue	Green
Female cable connector, red, blue, green		3	3–5 mm	99 9206 00 03	99 9206 05 03	99 9206 06 03	99 9206 07 03
		4		99 9210 05 04	99 9210 06 04	99 9210 07 04	
		5		99 9214 05 05	99 9214 06 05	99 9214 07 05	
		8		99 9226 05 08	99 9226 06 08	99 9226 07 08	



### Specifications

Contacts	3	4	5	8
Wire gauge	max. 0,25 mm <sup>2</sup> (max. AWG 24)			
Mechanical operation	> 500 Mating cycles			
Temperature range	– 25 °C / + 85 °C			
Rated voltage	125 V		63 V	
Pollution degree	2			
Rated current (40°C)	3 A	2,5 A	2 A	1 A
Contact plating	Au (Gold)			
Material of housing	PA			

Description	Drawing	Contacts	Cable length, PUR	Ordering-No.
Male cable connector, moulded		3 x 0,25	2 m	79 9237 020 03
		4 x 0,25		79 9241 020 04
		5 x 0,25		79 9245 020 05
		8 x 0,25		79 9257 020 08



Female cable connector, moulded		3 x 0,25	2 m	79 9238 020 03
		4 x 0,25		79 9242 020 04
		5 x 0,25		79 9246 020 05
		8 x 0,25		79 9258 020 08



Male panel mount connector, solder termination	Black		
		3	99 9207 00 03
	4	99 9211 00 04	
	5	99 9215 00 05	
	8	99 9227 00 08	

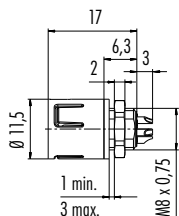

Male panel mount connector, solder termination	Black			Red	Blue	Green
		3	99 9207 050 03	99 9207 060 03	99 9207 070 03	
	4	99 9211 050 04	99 9211 060 04	99 9211 070 04		
	5	99 9215 050 05	99 9215 060 05	99 9215 070 05		
	8	99 9227 050 08	99 9227 060 08	99 9227 070 08		



Male panel mount connector, dip-solder termination	Black	
		3
	4	99 9211 090 04
	5	99 9215 090 05
	8	99 9227 090 08

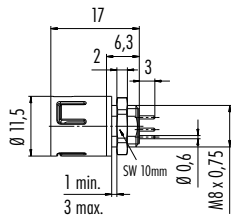

Female panel mount connector, solder termination	Black	
		3
	4	99 9212 00 04
	5	99 9216 00 05
	8	99 9228 00 08

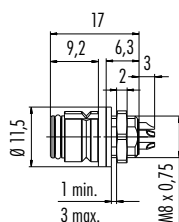

Description	Drawing	Contacts	Red	Blue	Green
Female panel mount connector, solder termination		3	99 9208 050 03	99 9208 060 03	99 9208 070 03
		4	99 9212 050 04	99 9212 060 04	99 9212 070 04
		5	99 9216 050 05	99 9216 060 05	99 9216 070 05
		8	99 9228 050 08	99 9228 060 08	99 9228 070 08



**Black**

Female panel mount connector, dip-solder termination	3	99 9208 090 03
	4	99 9212 090 04
	5	99 9216 090 05
	8	99 9228 090 08

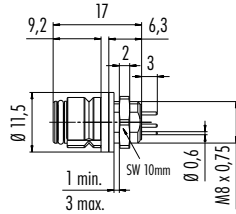

Adapter for panel mount connectors

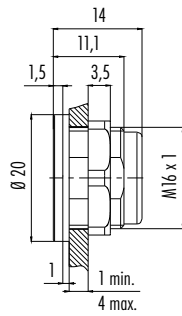

Adapter for panel mount connectors, front fastened

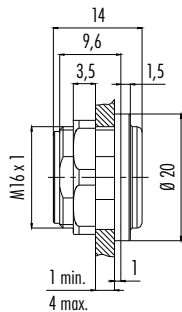

**Component part drawing**

Cable connectors

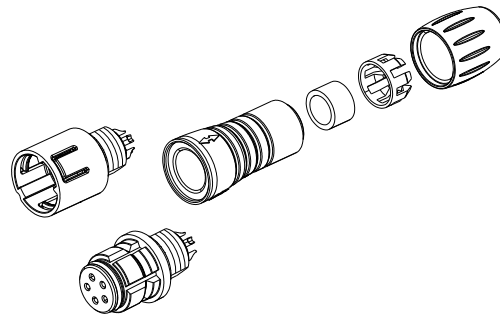

- Male insert
- Female insert
- Sleeve
- Seal
- Pinch ring
- Pressing screw

Panel mount connectors solder

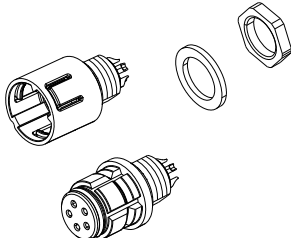

- Male insert
- Female insert
- Flat seal
- Hexagonal nut

Panel mount connectors dip-solder

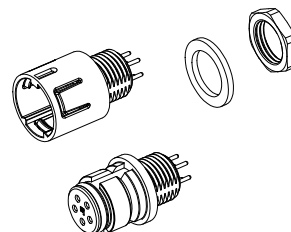

- Male insert
- Female insert
- Flat seal
- Hexagonal nut

## Component part drawing



## Contact arrangements male insert (mating side)



## Contact arrangements female insert (mating side)



## Panel cut out

Panel mount connectors

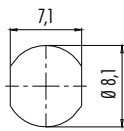

Adapter

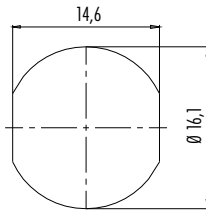

## Colour of wire, moulded cable connectors

- 1 white
- 2 brown
- 3 green
- 4 yellow
- 5 grey
- 6 pink
- 7 blue
- 8 red

## Description

## Drawing

## Ordering-No.

Protection cap for male cable connector

08 2813 000 000

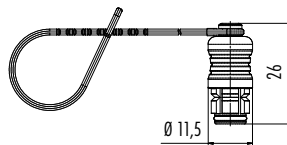

Protection cap for female cable connector

08 2823 000 000

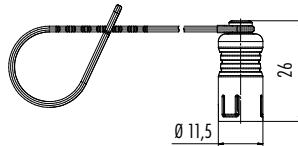

Protection cap for male panel mount connector

08 2839 000 000

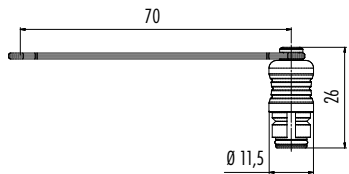

Protection cap for female panel mount connector

08 2831 000 000

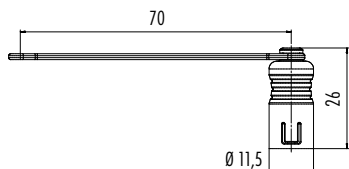

- Bayonet locking system
- 2 – 8 contacts
- Degree of protection IP40
- Solder termination
- Diameter 12 mm



### Description

Male cable connector



### Drawing



### Contacts

### Cable outlet 3–4 mm

### Cable outlet 4–5 mm

2	99 0971 100 02	99 0971 102 02
3	99 0975 100 03	99 0975 102 03
4	99 0979 100 04	99 0979 102 04
5	99 0995 100 05	99 0995 102 05
7	99 9475 100 07	99 9475 102 07
8	99 9479 100 08	99 9479 102 08

Female cable connector

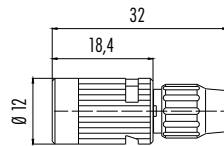

2	99 0972 100 02	99 0972 102 02
3	99 0976 100 03	99 0976 102 03
4	99 0980 100 04	99 0980 102 04
5	99 0996 100 05	99 0996 102 05
7	99 9476 100 07	99 9476 102 07
8	99 9480 100 08	99 9480 102 08

### Ordering-No.

Male panel mount connector

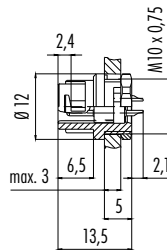

2	09 0973 00 02
3	09 0977 00 03
4	09 0981 00 04
5	09 0997 00 05
7	09 9477 00 07
8	09 9481 00 08

Female panel mount connector

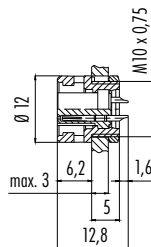

2	09 0974 00 02
3	09 0978 00 03
4	09 0982 00 04
5	09 0998 00 05
7	09 9478 00 07
8	09 9482 00 08

### Specifications

Contacts	2	3	4	5	7	8
Wire gauge	max. 0,25 mm <sup>2</sup> (max. AWG 24)				max. 0,14 mm <sup>2</sup> (max. AWG 26)	
Mechanical operation	> 500 Mating cycles					
Temperature range	- 40 °C / + 85 °C					
Rated voltage	125 V					
Pollution degree	1					
Rated current (40°C)	4 A		3 A		1 A	
Contact plating	Au (Gold)					
Material of housing	PA					

## Component part drawing

Male cable connector

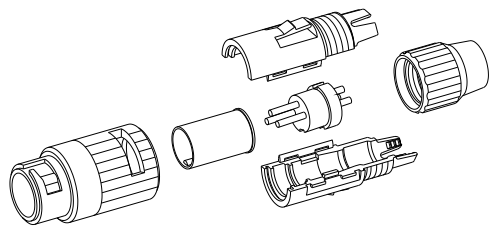

Connection ring male connector  
Sleeve  
Carrier sleeve part 1 and part 2  
Male insert  
Pressing screw

Female cable connector

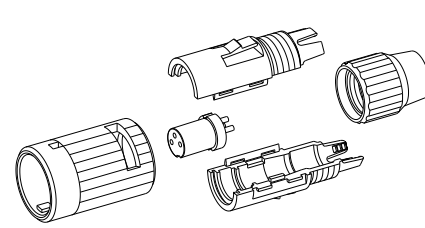

Connection ring female connector  
Carrier sleeve part 1 and part 2  
Female insert  
Pressing screw

## Contact arrangements male insert (mating side)

2 contacts

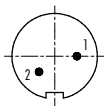

3 contacts

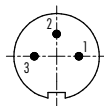

4 contacts

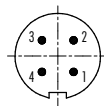

5 contacts

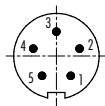

7 contacts

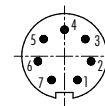

8 contacts

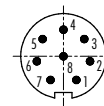

## Contact arrangements female insert (mating side)

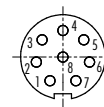
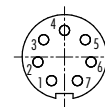
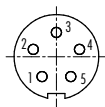
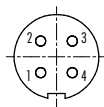
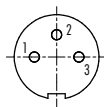
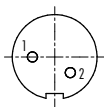

## Panel cut out

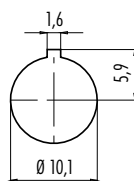

- Push-Pull locking system
- 3 – 5 contacts
- Degree of protection IP67
- Solder termination
- Diameter 9,5 mm



Description	Drawing	Contacts	Cable outlet	Ordering-No.
Male cable connector		3		99 4705 00 03
		4	3–4 mm	99 4709 00 04
		5		99 4713 00 05



Female cable connector		3		99 4706 00 03
		4	3–4 mm	99 4710 00 04
		5		99 4714 00 05



Male panel mount connector		3		09 4707 00 03
		4	-	09 4711 00 04
		5		09 4715 00 05



Female panel mount connector		3		09 4708 00 03
		4	-	09 4712 00 04
		5		09 4716 00 05



## Specifications

Contacts	3	4	5
Wire gauge	max. 0,14 mm <sup>2</sup> (max. AWG 26)		
Mechanical operation	> 1000 Mating cycles		
Temperature range	- 40 °C / + 80 °C		
Rated voltage	125 V		
Pollution degree	2		
Rated current (40°C)	1 A		
Contact plating	Au (Gold)		
Material of housing	PA		



## Component part drawing

Cable connectors

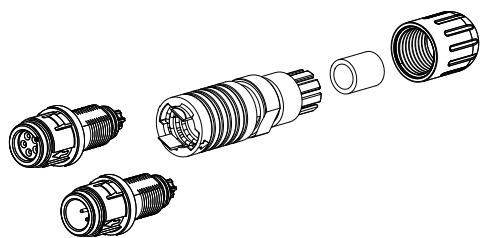

Female insert  
Male insert  
Locking device  
Seal  
Pressing screw

Panel mount connectors

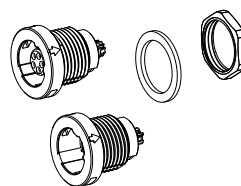

Female panel mount connector  
Male panel mount connector  
Flat seal  
Hexagonal nut

## Contact arrangements male insert (mating side)

3 contacts



4 contacts



5 contacts



## Contact arrangements female insert (mating side)



## Panel cut out

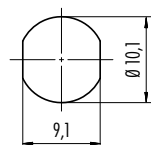



- Push-Pull locking system
- 3 – 8 contacts
- Degree of protection IP40/IP67
- Solder termination
- Diameter 14,5 mm
- Shieldable

### Description

Male cable connector, shieldable, IP67

### Drawing

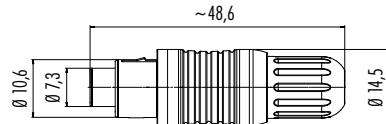

### Contacts

### Cable outlet

### Ordering-No.

3		99 4905 00 03
4		99 4909 00 04
5	3,5–5 mm	99 4913 00 05
7		99 4925 00 07
8		99 4929 00 08



Female cable connector, shieldable, IP67

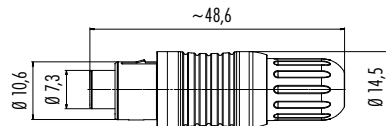

3		99 4906 00 03
4		99 4910 00 04
5	3,5–5 mm	99 4914 00 05
7		99 4926 00 07
8		99 4930 00 08



Male panel mount connector, IP40, IP67, shielded, IP67

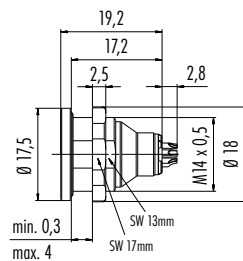

	IP40	IP67	Shielded, IP67
3	09 4907 025 03	09 4907 015 03	09 4907 00 03
4	09 4911 025 04	09 4911 015 04	09 4911 00 04
5	–	09 4915 015 05	09 4915 00 05
7	09 4927 025 07	09 4927 015 07	–
8	09 4931 025 08	09 4931 015 08	09 4931 00 08



Male panel mount connector, front fastened, IP67, shielded, IP67

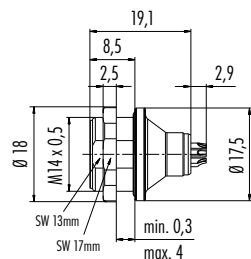

	IP67	Shielded, IP67
3	–	09 4907 080 03 09 4907 081 03
4	–	09 4911 081 04
5	–	09 4915 080 05 09 4915 081 05
7	–	09 4927 080 07 09 4927 081 07
8	–	09 4931 080 08 09 4931 081 08



### Specifications

Contacts	3	4	5	7	8
Wire gauge	0,25 mm <sup>2</sup> (AWG 24)			0,14 mm <sup>2</sup> (AWG 26)	
Mechanical operation	> 500 Mating cycles				
Temperature range	– 40 °C / + 85 °C				
Rated voltage <sup>1)</sup>	125 V				
Pollution degree	2				
Rated current (40°C)	4 A	3 A		1 A	
Contact plating	Au (Gold)				
Material of housing	PA				

Description	Drawing	Contacts	IP40	IP67	Shielded, IP67
Female panel mount connector, IP40, IP67, shielded, IP67		3	09 4908 025 03	09 4908 015 03	09 4908 00 03
		4	09 4912 025 04	09 4912 015 04	09 4912 00 04
		5	09 4916 025 05	09 4916 015 05	09 4916 00 05
		7	–	09 4928 015 07	09 4928 00 07
		8	09 4932 025 08	09 4932 015 08	09 4932 00 08

Description	Drawing	IP67	Shielded, IP67	
Female panel mount connector, front fastened, IP67, shielded, IP67		3	09 4908 080 03	09 4908 081 03
		4	09 4912 080 04	09 4912 081 04
		5	09 4916 080 05	09 4916 081 05
		7	09 4928 080 07	09 4928 081 07
		8	09 4932 080 08	09 4932 081 08

**Component part drawing**

Cable connectors

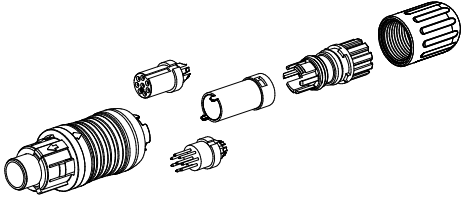

- Locking device
- Female insert
- Male insert
- Distance sleeve
- Clamping device
- Seal
- Pressing screw

Panel mount connectors

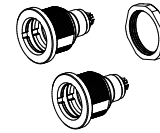

- Panel mount connector housing
- Female insert
- Male insert
- Hexagonal nut

**Contact arrangements male insert (mating side)**

3 contacts      4 contacts      5 contacts      7 contacts      8 contacts

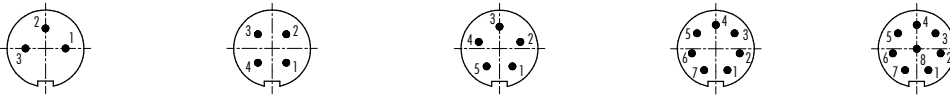

**Panel cut out**

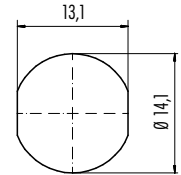

**Contact arrangements female insert (mating side)**

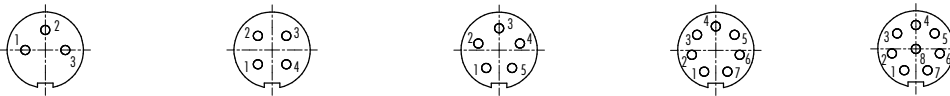

Description	Drawing	Ordering-No.
Protection cap for male cable connector		08 2965 000 000



Protection cap for female cable connector		08 2966 000 000
---	--	-----------------



- Screw termination M9
- 2 – 8 contacts
- Degree of protection IP40
- Solder termination
- Diameter 11,5 mm



Description	Drawing	Contacts	Cable outlet 3–4 mm	Cable outlet 4–5 mm
Male cable connector		2	99 0071 100 02	99 0071 102 02
		3	99 0075 100 03	99 0075 102 03
		4	99 0079 100 04	99 0079 102 04
		5	99 0095 100 05	99 0095 102 05
		7	99 0475 100 07	99 0475 102 07
		8	99 0479 100 08	99 0479 102 08

Female cable connector		2	99 0072 100 02	99 0072 102 02
		3	99 0076 100 03	99 0076 102 03
		4	99 0080 100 04	99 0080 102 04
		5	99 0096 100 05	99 0096 102 05
		7	99 0476 100 07	99 0476 102 07
		8	99 0480 100 08	99 0480 102 08

Description	Drawing	Contacts	Ordering-No.
Male panel mount connector, solder termination		2	09 0073 00 02
		3	09 0077 00 03
		4	09 0081 00 04
		5	09 0097 00 05
		7	09 0477 00 07
		8	09 0481 00 08

max. wall thickness: 1,5 mm

Male panel mount connector, dip-solder termination		2	09 0073 20 02
		3	09 0077 20 03
		4	09 0081 20 04
		5	09 0097 20 05
		7	09 0477 22 07
		8	09 0481 22 08

max. wall thickness: 1,5 mm

Specifications						
Contacts	2	3	4	5	7	8
Wire gauge	max. 0,25 mm <sup>2</sup> (max. AWG 24)				max. 0,14 mm <sup>2</sup> (max. AWG 26)	
Mechanical operation	> 500 Mating cycles					
Temperature range	- 40 °C / + 85 °C					
Rated voltage <sup>1)</sup>	125 V					
Pollution degree	1					
Rated current (40°C)	4 A		3 A		1 A	
Contact plating	Au (Gold)					
Material of housing	PA					

**Description**

**Drawing**

**Contacts**

**Ordering-No.**

Female panel mount connector, solder termination

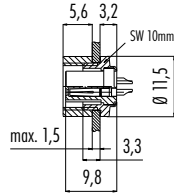

2	09 0074 00 02
3	09 0078 00 03
4	09 0082 00 04
5	09 0098 00 05
7	09 0478 00 07
8	09 0482 00 08

Female panel mount connector, dip-solder termination

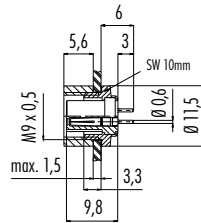

2	09 0074 20 02
3	09 0078 20 03
4	09 0082 20 04
5	09 0098 20 05
7	09 0478 22 07
8	09 0482 22 08

Female angled panel mount connector, dip-solder termination

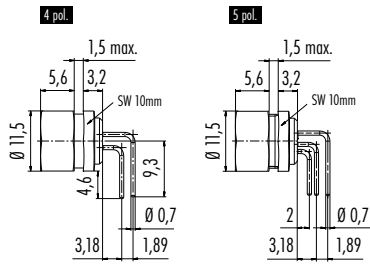

2	-
3	-
4	09 0082 32 04
5	09 0098 72 05
7	-
8	-

**Male panel mount connector      Female panel mount connector**

Male panel mount connector/Female panel mount connector with flexible PCB

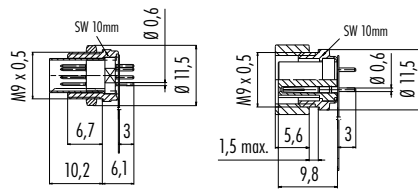

max. wall thickness: 1,5 mm

2	-	-
3	-	-
4	-	-
5	-	-
7	09 0477 65 07	09 0478 65 07
8	09 0481 65 08	09 0482 65 08

**Component part drawing**

Male cable connector

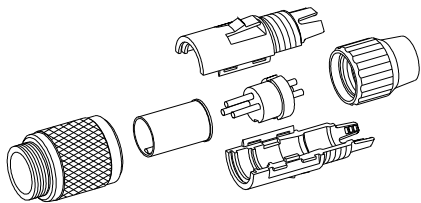

Connection ring male connector

Sleeve

Carrier sleeve part 1 and part 2

Male insert

Pressing screw

Attention:  
max. torque of ring nut in panel mount connector: 50cNm (manual adjustment)

Female cable connector

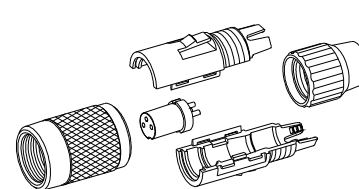

Connection ring male connector

Sleeve

Carrier sleeve part 1 and part 2

Female insert

Pressing screw

Attention:  
max. torque of ring nut in panel mount connector: 50cNm (manual adjustment)

**Contact arrangements male insert (mating side)**

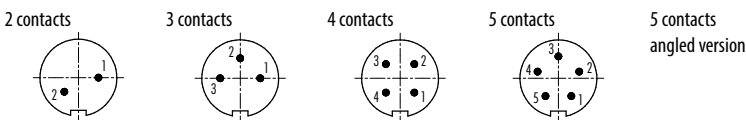

**Panel cut out**

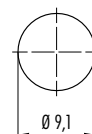

**Contact arrangements female insert (mating side)**

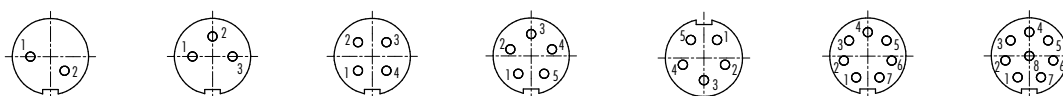



- Screw termination M9
- 2 – 8 contacts
- Degree of protection IP67
- Solder termination
- Moulded versions
- Diameter 11,5 – 14 mm

Description	Drawing	Contacts	Cable outlet	Ordering-No.
Male angled connector		2 3 4 5 7 8	3,5–5 mm	99 0401 70 02 99 0405 70 03 99 0409 70 04 99 0413 70 05 99 0421 70 07 99 0425 70 08
Male angled connector, shieldable		2 3 4 5 7 8	3,5–5 mm	99 0401 75 02 99 0405 75 03 99 0409 75 04 99 0413 75 05 99 0421 75 07 99 0425 75 08
Female angled connector		2 3 4 5 7 8	3,5–5 mm	99 0402 70 02 99 0406 70 03 99 0410 70 04 99 0414 70 05 99 0422 70 07 99 0426 70 08
Female angled connector, shieldable		2 3 4 5 7 8	3,5–5 mm	99 0402 75 02 99 0406 75 03 99 0410 75 04 99 0414 75 05 99 0422 75 07 99 0426 75 08

### Specifications

Contacts	2	3	4	5	7	8
Wire gauge	max. 0,25 mm <sup>2</sup> (max. AWG 24)				max. 0,14 mm <sup>2</sup> (max. AWG 26)	
Mechanical operation	> 500 Mating cycles					
Temperature range	– 40 °C / + 85 °C					
Rated voltage <sup>1)</sup>	125 V					
Pollution degree	1					
Rated current (40°C)	4 A		3 A		1 A	
Contact plating	Au (Gold)					
Material of housing	PA, CuZn (brass, nickel plated)					

### Description

### Drawing

### Contacts Cable outlet

### Ordering-No.

Male cable connector

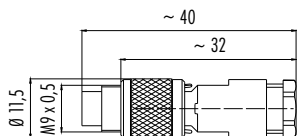

2		99 0401 00 02
3		99 0405 00 03
4	3,5–5 mm	99 0409 00 04
5		99 0413 00 05
7		99 0421 00 07
8		99 0425 00 08

Male cable connector, shieldable

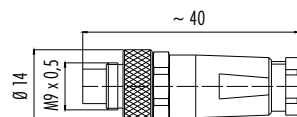

2		99 0401 10 02
3		99 0405 10 03
4	3,5–5 mm	99 0409 10 04
5		99 0413 10 05
7		99 0421 10 07
8		99 0425 10 08

Male cable connector, shieldable, iris type spring

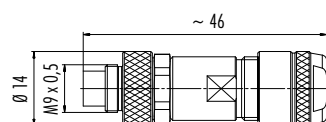

2		99 0401 115 02
3		99 0405 115 03
4	4–5,5 mm	99 0409 115 04
5		99 0413 115 05
7		99 0421 115 07
8		99 0425 115 08

Female cable connector

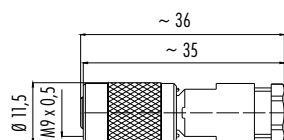

2		99 0402 00 02
3		99 0406 00 03
4	3,5–5 mm	99 0410 00 04
5		99 0414 00 05
7		99 0422 00 07
8		99 0426 00 08

Female cable connector, shieldable

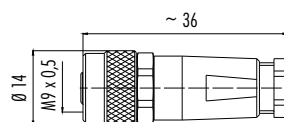

2		99 0402 10 02
3		99 0406 10 03
4	3,5–5 mm	99 0410 10 04
5		99 0414 10 05
7		99 0422 10 07
8		99 0426 10 08

Female cable connector, shieldable, iris type spring

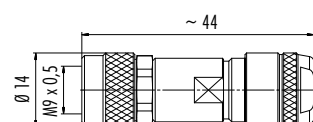

2		99 0402 115 02
3		99 0406 115 03
4	4–5,5 mm	99 0410 115 04
5		99 0414 115 05
7		99 0422 115 07
8		99 0426 115 08

**Description**

Male cable connector, moulded

**Drawing**

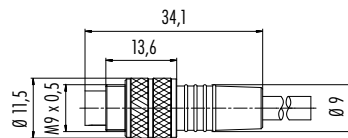

**Contacts**

**Cable length, PUR**

**Ordering-No.**

3 x 0,25	2 m	79 1451 212 03
	5 m	79 1451 215 03
5 x 0,25	2 m	79 1455 212 05
	5 m	79 1455 215 05
8 x 0,25	2 m	79 1461 212 08
	5 m	79 1461 215 08

Male cable connector, moulded, shielded

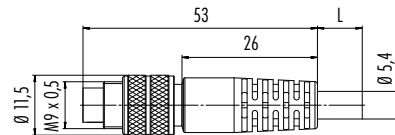

2 x 0,25	2 m	79 1401 12 02
	5 m	79 1401 15 02
3 x 0,25	2 m	79 1405 12 03
	5 m	79 1405 15 03
4 x 0,25	2 m	79 1409 12 04
	5 m	79 1409 15 04
5 x 0,25	2 m	79 1413 12 05
	5 m	79 1413 15 05
7 x 0,14	2 m	79 1421 12 07
	5 m	79 1421 15 07
8 x 0,14	2 m	79 1425 12 08
	5 m	79 1425 15 08

Male angled connector, moulded

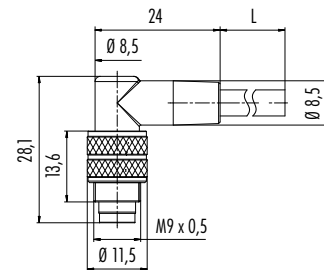

3 x 0,25	2 m	79 1451 272 03
	5 m	79 1451 275 03
5 x 0,25	2 m	79 1455 272 05
	5 m	79 1455 275 05
8 x 0,25	2 m	79 1461 272 08
	5 m	79 1461 275 08

Male angled connector, moulded, shielded

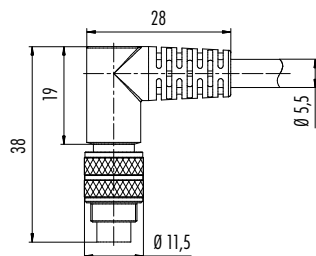

2 x 0,25	2 m	79 1401 72 02
	5 m	79 1401 75 02
3 x 0,25	2 m	79 1405 72 03
	5 m	79 1405 75 03
4 x 0,25	2 m	79 1409 72 04
	5 m	79 1409 75 04
5 x 0,25	2 m	79 1413 72 05
	5 m	79 1413 75 05
7 x 0,14	2 m	79 1421 72 07
	5 m	79 1421 75 07
8 x 0,14	2 m	79 1425 72 08
	5 m	79 1425 75 08

**Contact arrangements male insert (mating side)**

2 contacts



3 contacts



4 contacts



5 contacts



7 contacts



8 contacts



**Contact arrangements female insert (mating side)**



**Panel cut out**

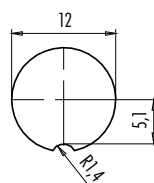

**Colour of wire, moulded cable connectors**

1 white	5 grey
2 brown	6 pink
3 green	7 blue
4 yellow	8 red



**Description**

**Drawing**

**Contacts**

**Cable length, PUR**

**Ordering-No.**

Female cable connector, moulded

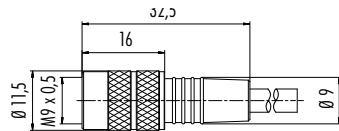

3 x 0,25	2 m	79 1452 212 03
	5 m	79 1452 215 03
5 x 0,25	2 m	79 1456 212 05
	5 m	79 1456 215 05
8 x 0,25	2 m	79 1462 212 08
	5 m	79 1462 215 08

Female cable connector, moulded, shielded

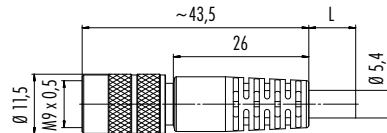

2 x 0,25	2 m	79 1402 12 02
	5 m	79 1402 15 02
3 x 0,25	2 m	79 1406 12 03
	5 m	79 1406 15 03
4 x 0,25	2 m	79 1410 12 04
	5 m	79 1410 15 04
5 x 0,25	2 m	79 1414 12 05
	5 m	79 1414 15 05
7 x 0,14	2 m	79 1422 12 07
	5 m	79 1422 15 07
8 x 0,14	2 m	79 1426 12 08
	5 m	79 1426 15 08

Female angled connector, moulded

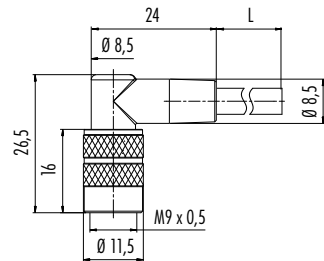





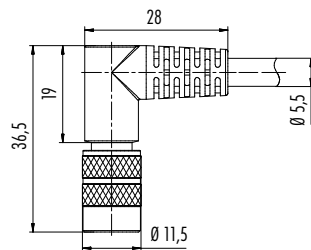



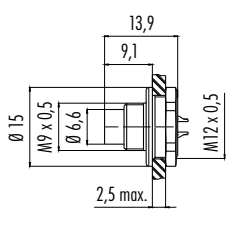

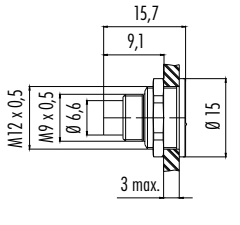

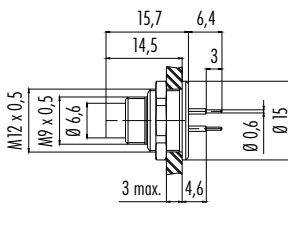

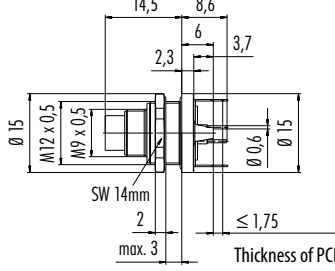

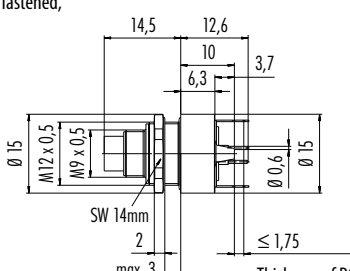

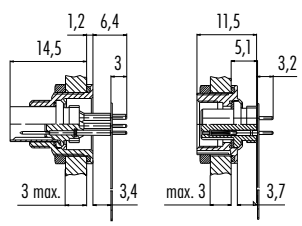

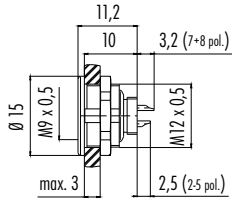

3 x 0,25	2 m	79 1452 272 03
	5 m	79 1452 275 03
5 x 0,25	2 m	79 1456 272 05
	5 m	79 1456 275 05
8 x 0,25	2 m	79 1462 272 08
	5 m	79 1462 275 08

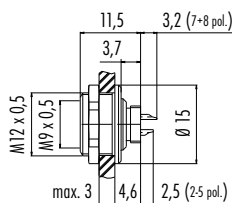
Female angled connector, moulded, shielded

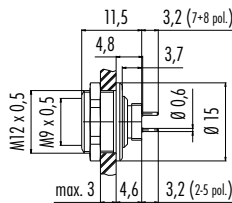

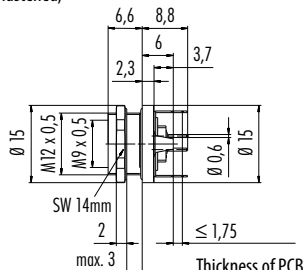
2 x 0,25	2 m	79 1402 72 02
	5 m	79 1402 75 02
3 x 0,25	2 m	79 1406 72 03
	5 m	79 1406 75 03
4 x 0,25	2 m	79 1410 72 04
	5 m	79 1410 75 04
5 x 0,25	2 m	79 1414 72 05
	5 m	79 1414 75 05
7 x 0,14	2 m	79 1422 72 07
	5 m	79 1422 75 07
8 x 0,14	2 m	79 1426 72 08
	5 m	79 1426 75 08

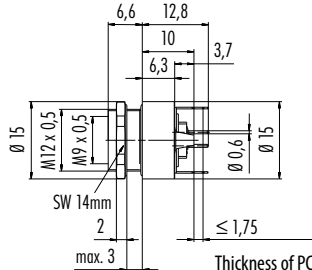
Description	Drawing	Contacts	Ordering-No.														
Male panel mount connector 		2 3 4 5 7 8	09 0403 00 02 09 0407 00 03 09 0411 00 04 09 0415 00 05 09 0423 00 07 09 0427 00 08														
Male panel mount connector, front fastened 		2 3 4 5 7 8	09 0403 80 02 09 0407 80 03 09 0411 80 04 09 0415 80 05 09 0423 80 07 09 0427 80 08														
Male panel mount connector, dip-solder termination, front fastened 		2 3 4 5 7 8	09 0403 90 02 09 0407 90 03 09 0411 90 04 09 0415 90 05 09 0423 90 07 09 0427 90 08														
Male panel mount connector, dip-solder termination, front fastened, shielding sheet 6 mm 		2 3 4 5 7 8	09 0403 30 02 09 0407 30 03 09 0411 30 04 09 0415 30 05 09 0423 30 07 09 0427 30 08														
Male panel mount connector, dip-solder termination, front fastened, shielding sheet 10 mm 		2 3 4 5 7 8	09 0403 35 02 09 0407 35 03 09 0411 35 04 09 0415 35 05 09 0423 35 07 09 0427 35 08														
Male panel mount connector/Female panel mount connector with flexible PCB 		2 3 4 5 7 8	<table border="1"> <thead> <tr> <th data-bbox="989 1803 1244 1825">Male panel mount connector</th> <th data-bbox="1244 1803 1527 1825">Female panel mount connector</th> </tr> </thead> <tbody> <tr> <td>–</td> <td>–</td> </tr> <tr> <td>–</td> <td>–</td> </tr> <tr> <td>–</td> <td>–</td> </tr> <tr> <td>–</td> <td>–</td> </tr> <tr> <td>09 0423 65 07</td> <td>09 0424 65 07</td> </tr> <tr> <td>09 0427 65 08</td> <td>09 0428 65 08</td> </tr> </tbody> </table>	Male panel mount connector	Female panel mount connector	–	–	–	–	–	–	–	–	09 0423 65 07	09 0424 65 07	09 0427 65 08	09 0428 65 08
Male panel mount connector	Female panel mount connector																
–	–																
–	–																
–	–																
–	–																
09 0423 65 07	09 0424 65 07																
09 0427 65 08	09 0428 65 08																

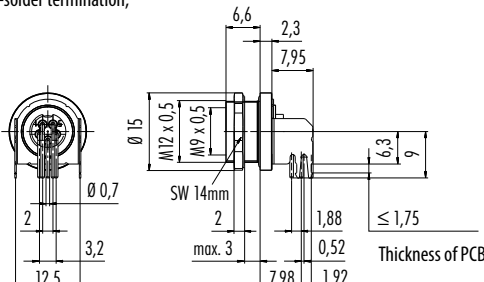
Description	Drawing	Contacts	Ordering-No.
Female panel mount connector 		2 3 4 5 7 8	09 0404 00 02 09 0408 00 03 09 0412 00 04 09 0416 00 05 09 0424 00 07 09 0428 00 08
Female panel mount connector, front fastened 		2 3 4 5 7 8	09 0404 80 02 09 0408 80 03 09 0412 80 04 09 0416 80 05 09 0424 80 07 09 0428 80 08
Female panel mount connector, dip-solder termination, front fastened 		2 3 4 5 7 8	09 0404 90 02 09 0408 90 03 09 0412 90 04 09 0416 90 05 09 0424 90 07 09 0428 90 08
Female panel mount connector, dip-solder termination, front fastened, shielding sheet 6 mm 		2 3 4 5 7 8	09 0404 30 02 09 0408 30 03 09 0412 30 04 09 0416 30 05 09 0424 30 07 09 0428 30 08
Female panel mount connector, dip-solder termination, front fastened, shielding sheet 10 mm 		2 3 4 5 7 8	09 0404 35 02 09 0408 35 03 09 0412 35 04 09 0416 35 05 09 0424 35 07 09 0428 35 08
Female angled panel mount connector, dip-solder termination, front fastened, shielding sheet 		2 3 4 5 7 8	09 0404 55 02 - - 09 0416 55 05 - -

## Component part drawing

### Cable connectors

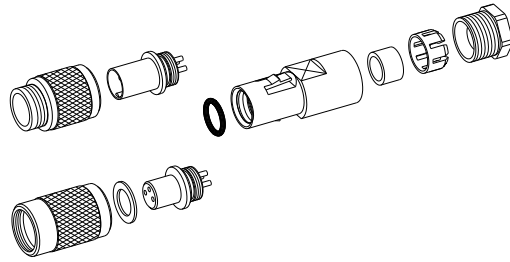

- Connection ring male connector
- Connection ring female connector
- Flat seal
- Female insert
- Male insert
- O-ring 6x1
- Snap bushing
- Seal
- Pinch ring
- Pressing screw

### Cable connectors, shieldable

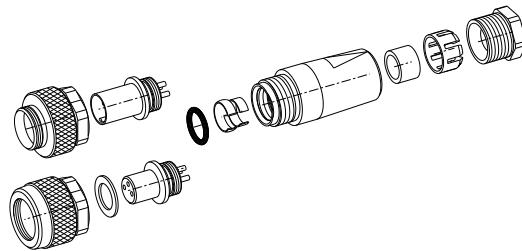

- Connection ring male connector
- Connection ring female connector
- Flat seal
- Female insert
- Male insert
- O-ring 6x1
- Snap bushing
- Seal
- Pinch ring
- Pressing screw

### Cable connectors, shieldable, with iris type spring

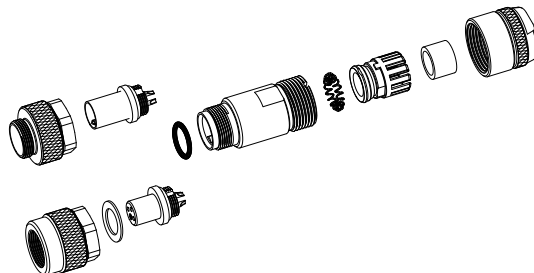

- Connection ring male connector
- Connection ring female connector
- Female insert
- Male insert
- Sleeve
- Iris type spring
- Pinch ring
- Seal
- Pressing screw

### Angled connectors

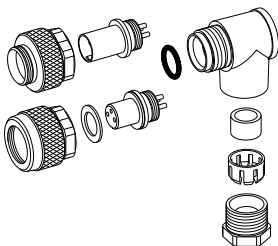

- Connection ring male connector
- Connection ring female connector
- Dichtung
- Female insert solder
- Male insert solder
- O-ring 6x1
- Angled housing seal
- Pinch ring
- Pressing screw
- Cable outlet adjustable in 2 positions (0°/180°)

### Angled connectors, shielded

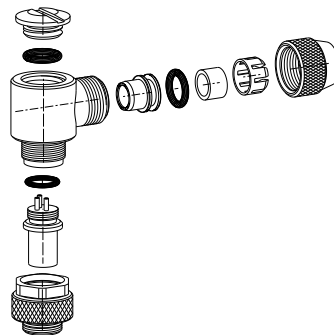

- Connection ring male connector
- Male insert
- O-ring 6x1,5
- Angled housing
- O-ring 6x1,5
- Screw plug
- Shielding ring
- O-ring 6x1,5
- Seal
- Pinch ring
- Pressing screw
- Cable outlet adjustable in 2 positions (0°/180°)

**Description**

Adapter lead-through for control cabinet



**Drawing**

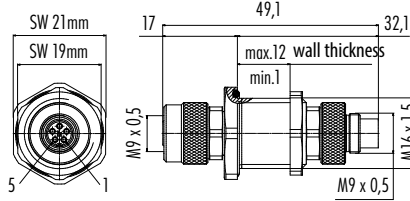

**Contacts**

5

**Ordering-No.**

09 9618 100 05

**Ordering-No.**

08 0349 000 001

Protection cap for male cable connector

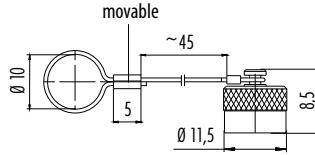

Protection cap for female cable connector

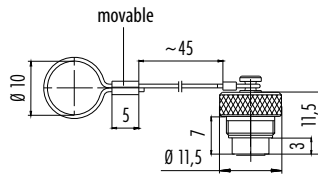

08 0350 000 001

Protection cap for male panel mount connector

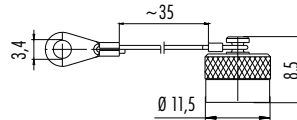

08 0351 000 001

Protection cap for female panel mount connector

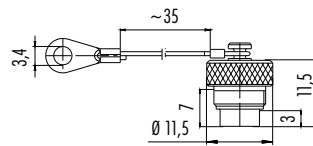

08 0352 000 001

Square flange with seal

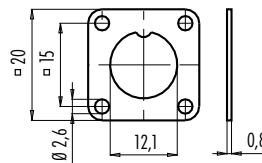

08 1124 000 001

Solder eye ring

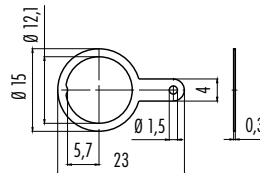

04 0208 002

Knurled hexagonal nut, 2 mm, 4 mm

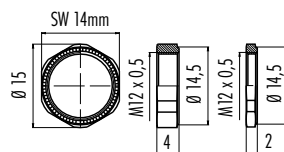

01 0013 001 2 mm thickness

01 5023 001 4 mm thickness

Mounting spanner

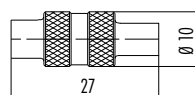

01 5059 001

- Snap-in locking system
- 3 – 12 contacts
- Degree of protection IP67
- Solder termination
- Moulded versions
- Diameter 16 mm
- Coloured versions



### Description

Male cable connector

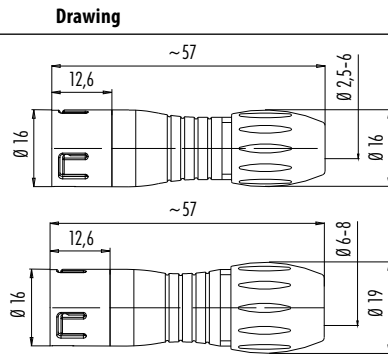

Male cable connector, red, blue, green



Female cable connector

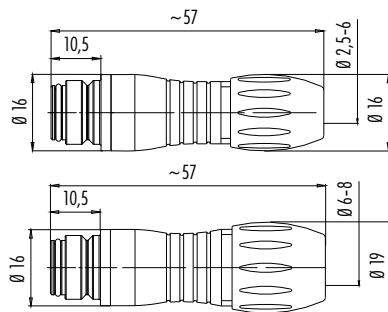

Female cable connector, red, blue, green



### Specifications

Contacts	3	5	8	12
Wire gauge	max. 0,75 mm <sup>2</sup> (max. AWG 20)		max. 0,25 mm <sup>2</sup> (max. AWG 24)	
Mechanical operation	> 500 Mating cycles			
Temperature range	- 25 °C / + 85 °C			
Rated voltage	250 V	125 V		60 V
Pollution degree	2			
Rated current (40°C)	7 A	5 A	2 A	
Contact plating	Au (Gold)			
Material of housing	PA			

Contacts	Cable-Ø 2,5–4 mm	Cable-Ø 4–6 mm	Cable-Ø 6–8 mm
3	99 9105 03 03	99 9105 00 03	99 9105 02 03
5	99 9113 03 05	99 9113 00 05	99 9113 02 05
8	99 9125 03 08	99 9125 00 08	99 9125 02 08
12	99 9133 03 12	99 9133 00 12	99 9133 02 12



Contacts	Cable outlet	Red	Blue	Green
3		99 9105 50 03	99 9105 60 03	99 9105 70 03
5	4–6 mm	99 9113 50 05	99 9113 60 05	99 9113 70 05
8		99 9125 50 08	99 9125 60 08	99 9125 70 08
12	6–8 mm	99 9133 52 12	99 9133 62 12	99 9133 72 12



Contacts	Cable-Ø 2,5–4 mm	Cable-Ø 4–6 mm	Cable-Ø 6–8 mm
3	99 9106 03 03	99 9106 00 03	99 9106 02 03
5	99 9114 03 05	99 9114 00 05	99 9114 02 05
8	99 9126 03 08	99 9126 00 08	99 9126 02 08
12	99 9134 03 12	99 9134 00 12	99 9134 02 12



Contacts	Cable outlet	Red	Blue	Green
3		99 9106 50 03	99 9106 60 03	99 9106 70 03
5	4–6 mm	99 9114 50 05	99 9114 60 05	99 9114 70 05
8		99 9126 50 08	99 9126 60 08	99 9126 70 08
12	6–8 mm	99 9134 52 12	99 9134 62 12	99 9134 72 12



## Description

Male cable connector, moulded



## Drawing

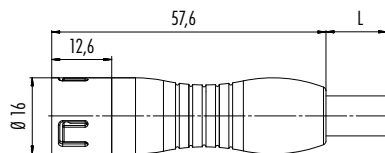

## Contacts

3 x 0,75  
5 x 0,75  
8 x 0,25  
12 x 0,25

## Cable length, PVC

2 m

## Ordering-No.

79 9149 020 03  
79 9157 020 05  
79 9169 020 08  
79 9177 020 12

Female cable connector, moulded

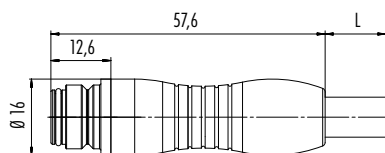

3 x 0,75  
5 x 0,75  
8 x 0,25  
12 x 0,25

2 m

79 9150 020 03  
79 9158 020 05  
79 9170 020 08  
79 9178 020 12

Male panel mount connector, solder termination

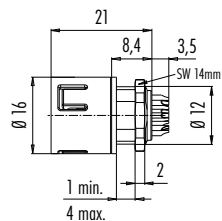

## Black

3 99 9107 00 03  
5 99 9115 00 05  
8 99 9127 00 08  
12 99 9135 00 12

Male panel mount connector, solder termination



## Red Blue Green

3 99 9107 50 03 99 9107 60 03 99 9107 70 03  
5 99 9115 50 05 99 9115 60 05 99 9115 70 05  
8 99 9127 50 08 99 9127 60 08 99 9127 70 08  
12 99 9135 50 12 99 9135 60 12 99 9135 70 12

Male panel mount connector, dip-solder termination

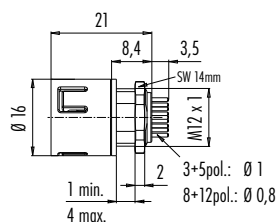

## Black

3 99 9107 090 03  
5 99 9115 090 05  
8 99 9127 090 08  
12 99 9135 090 12

Female panel mount connector, solder termination

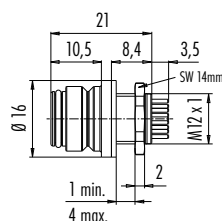

3 99 9108 00 03  
5 99 9116 00 05  
8 99 9128 00 08  
12 99 9136 00 12

**Description**

**Drawing**

**Contacts**

**Red**

**Blue**

**Green**

Female panel mount connector, solder termination

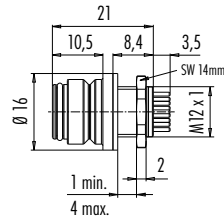

3	99 9108 50 03	99 9108 60 03	99 9108 70 03
5	99 9116 50 05	99 9116 60 05	99 9116 70 05
8	99 9128 50 08	99 9128 60 08	99 9128 70 08
12	99 9136 50 12	99 9136 60 12	99 9136 70 12

Female panel mount connector, dip-solder termination

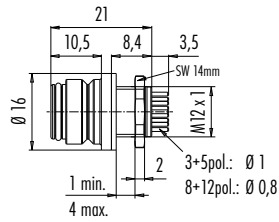

**Black**

3	99 9108 090 03
5	99 9116 090 05
8	99 9128 090 08
12	99 9136 090 12

**Ordering-No.**

08 2433 000 001

Adapter for panel mount connectors

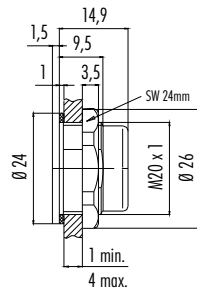

Adapter for panel mount connectors, front fastened

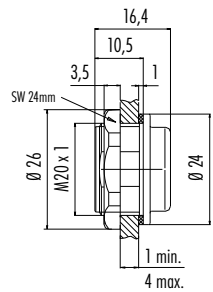

08 2434 000 001



## Component part drawing

Cable connectors

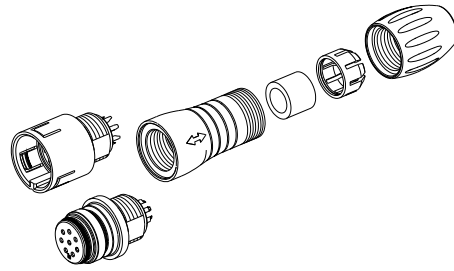

Male insert  
Female insert  
Sleeve  
Seal  
Pinch ring  
Pressing screw

Panel mount connectors, solder

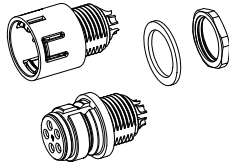

Male insert  
Female insert  
Flat seal  
Hexagonal nut

Panel mount connectors, dip-solder

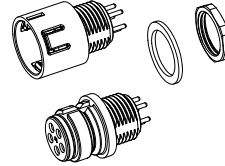

Male insert  
Female insert  
Flat seal  
Hexagonal nut

Assembly Adapter

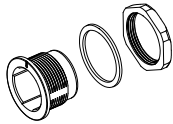

Adapter  
Flat seal  
Hexagonal nut

Assembly Adapter, front fastened

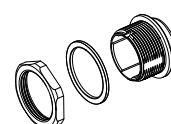

Hexagonal nut  
Flat seal  
Adapter

## Contact arrangements male insert (mating side)

3 contacts

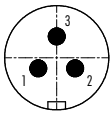

5 contacts

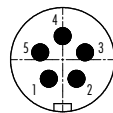

8 contacts

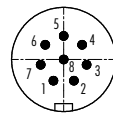

12 contacts

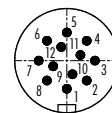

## Contact arrangements female insert (mating side)

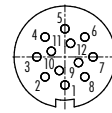
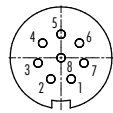
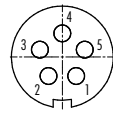
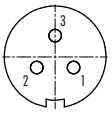

## Panel cut out

Panel mount connectors

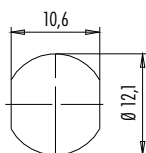

Adapter

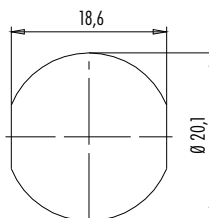

## Colour of wire, moulded cable connectors

- |          |              |
|----------|--------------|
| 1 white  | 7 blue       |
| 2 brown  | 8 red        |
| 3 green  | 9 black      |
| 4 yellow | 10 purple    |
| 5 grey   | 11 grey/pink |
| 6 pink   | 12 red/blue  |

**Description**

**Drawing**

**Ordering-No.**

Protection cap for male cable connector

08 2587 000 000

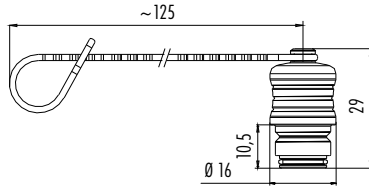

Protection cap for female cable connector

08 2586 000 000

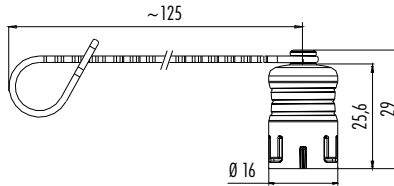

Protection cap for male panel mount connector

**Hole-Ø D**

**Ordering-No.**

3 mm	08 2559 000 000
12 mm	08 2680 000 000
20 mm	08 2674 000 000

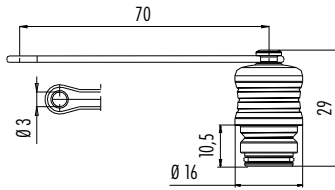
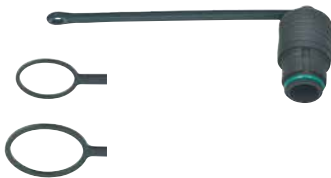

Protection cap for female panel mount connector

3 mm 08 2567 000 000

12 mm 08 2681 000 000

20 mm 08 2675 000 000

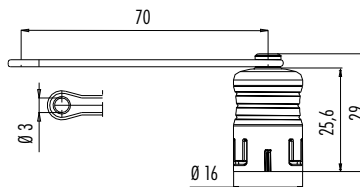
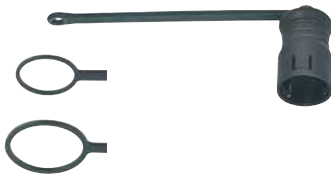



- Bayonet locking system
- 2 – 24 contacts
- Degree of protection IP40
- Solder termination
- Diameter approx. 20 mm
- Touch-proof plastic housing



Description	Drawing	Contacts	Cable outlet	Ordering-No.
Male cable connector		3 DIN	4–6 mm	99 0605 00 03
		4		99 0609 00 04
		5		99 0613 00 05
		6 DIN		99 0617 00 06
		7		99 0621 00 07
		8 DIN		99 0645 00 08
		12	99 0649 00 12	

Male angled connector		3 DIN	4–6 mm	99 0605 70 03
		4		99 0609 70 04
		5		99 0613 70 05
		6 DIN		99 0617 70 06
		7		99 0621 70 07
		8 DIN		99 0645 70 08
		12	99 0649 70 12	

Female cable connector		3 DIN	4–6 mm	99 0606 00 03
		4		99 0610 00 04
		5		99 0614 00 05
		6 DIN		99 0618 00 06
		7		99 0622 00 07
		8 DIN		99 0646 00 08
		12	99 0650 00 12	

Female angled connector		3 DIN	4–6 mm	99 0606 70 03
		4		99 0610 70 04
		5		99 0614 70 05
		6 DIN		99 0618 70 06
		7		99 0622 70 07
		8 DIN		99 0646 70 08
		12	99 0650 70 12	

Specifications								
Contacts	3 DIN	4	5	6 DIN	7	8 DIN	12	
Wire gauge	max. 0,75 mm <sup>2</sup> (max. AWG 20)						max. 0,25 mm <sup>2</sup> (max. AWG 24)	
Mechanical operation	> 500 Mating cycles							
Temperature range	– 40 °C / + 85 °C							
Rated voltage	250 V (32 V)			125 V (32 V)		60 V (32 V)		
Pollution degree	1 (2) <sup>1)</sup>							
Rated current (40°C)	7 A		6 A			5 A		
Contact plating	Ag (Silver)						Au (Gold)	
Material of housing	PA							

**Description**

**Drawing**

**Contacts**

**Ordering-No.**

Male panel mount connector

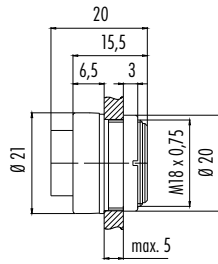

3 DIN	99 0607 00 03
4	99 0611 00 04
5	99 0615 00 05
6 DIN	99 0619 00 06
7	99 0623 00 07
8 DIN	99 0647 00 08
12	99 0651 00 12

Female panel mount connector

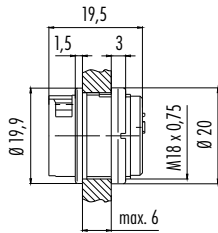

3 DIN	99 0608 00 03
4	99 0612 00 04
5	99 0616 00 05
6 DIN	99 0620 00 06
7	99 0624 00 07
8 DIN	99 0648 00 08
12	99 0652 00 12

**Component part drawing**

Male cable connector

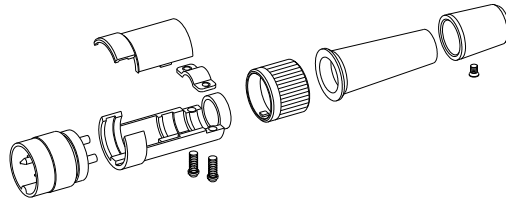

- Male insert
- Carrier sleeve
- Fillister head screw
- Strap
- Cover
- Locking ring
- Cable bushing
- Self-tapping screw
- Sleeve

Female cable connector

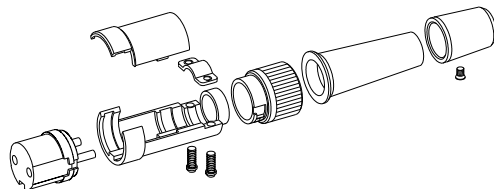

- Female insert
- Carrier sleeve
- Fillister head screw
- Strap
- Cover
- Locking ring
- Cable bushing
- Self-tapping screw
- Sleeve

Male angled connector

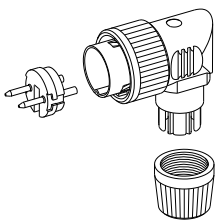

- Male insert
- Male angled housing
- Pressing screw
- Cable outlet not adjustable

Female angled connector

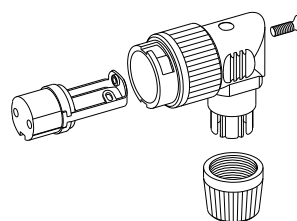

- Female insert
- Holding device
- Female angled housing
- Countersunk screw
- Pressing screw
- Cable outlet not adjustable

## Contact arrangements male insert (mating side)

3 DIN contacts

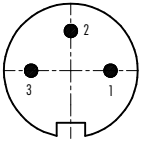

4 contacts

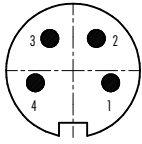

5 contacts

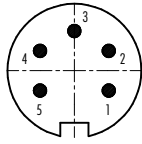

6 DIN contacts

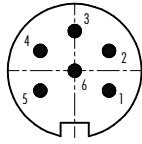

7 contacts

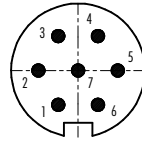

8 DIN contacts

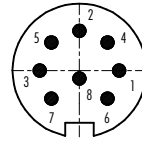

12 contacts

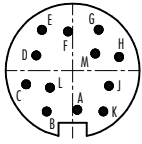

## Contact arrangements female insert (mating side)

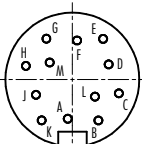
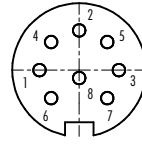
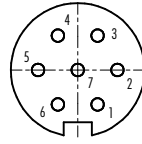
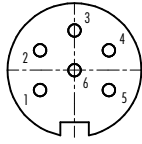
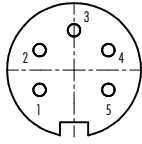
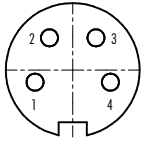
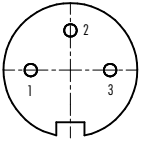

## Panel cut out

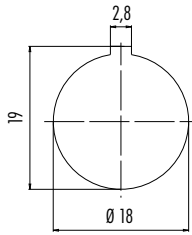

## Description

## Drawing

## Ordering-No.

Blind plug

08 2668 000 001

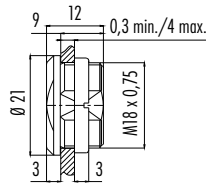

Mounting spanner for panel mount connectors

07 0010 001

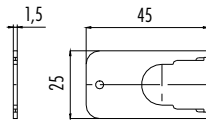

Rectangular flange for panel mount connectors, IP40

04 0106 001

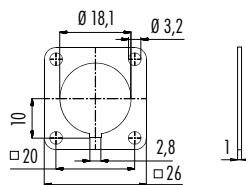

Ring nut for fixing thread

01 0010 001 with knurled screw

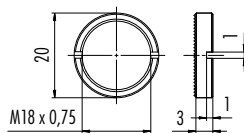

Hexagonal nut

Thickness

Ordering-No.

2,5 mm 01 0146 001

5 mm 01 5006 001

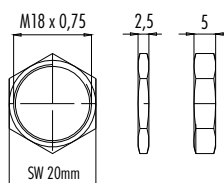





- Bayonet locking system
- 8 contacts
- Degree of protection IP67
- Solder termination
- Diameter 19,9 mm
- > 5000 Mating cycles
- Panel mount connectors:  
Degree of protection IP67 even when not connected

Description	Drawing	Contacts	Cable outlet 2,5–4 mm	Cable outlet 4–6 mm
Male cable connector		8	99 0771 000 08	99 0771 001 08

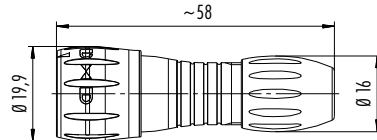

Male cable connector

Contacts	Cable outlet 6–8 mm
8	99 0771 002 08

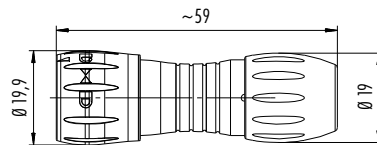

Female panel mount connector, solder

Contacts	Ordering-No.
8	09 0774 000 08

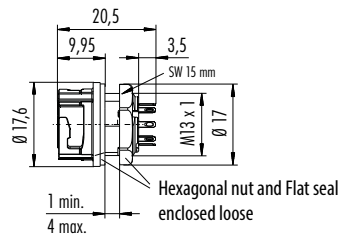

Female panel mount connector, solder, front fastened

8	09 0774 180 08
---	----------------

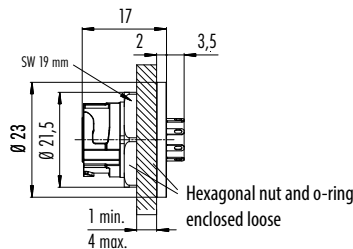

■ NEW

## Specifications

Contacts	8
Wire gauge	0,25 mm <sup>2</sup> (AWG 24)
Mechanical operation	> 5000 Mating cycles
Temperature range	-25 °C / +85 °C
Rated voltage	175 V
Pollution degree	2
Rated current (40°C)	2 A
Contact plating	Au (Gold)
Material of housing	PA



	<b>Ordering-No.</b>
Female panel mount connector, dip-solder	8 09 0774 090 08

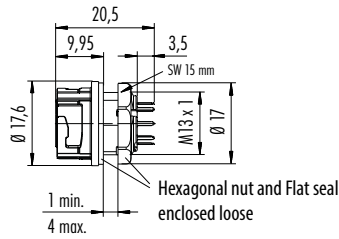

Female panel mount connector, dip-solder, front fastened	8 09 0774 190 08
--	------------------

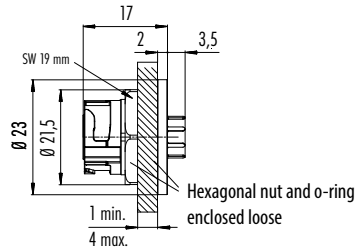

■ NEW

### Component part drawing

Cable connectors

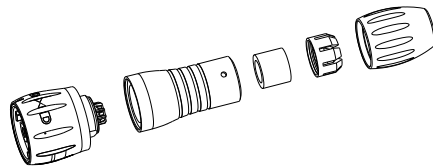

- Male insert
- Sleeve
- Seal
- Pinch ring
- Pressing screw

Panel mount connectors, solder	Female insert Panel mount connector housing with colour coding Flat seal Hexagonal nut	Panel mount connectors, dip-solder	Female insert Panel mount connector housing with colour coding Flat seal Hexagonal nut	Female panel mount connectors, front fastened, solder/dip-solder	Hexagonal nut O-ring Female panel mount connector

### Contact arrangement male insert (termination side)

8 contacts

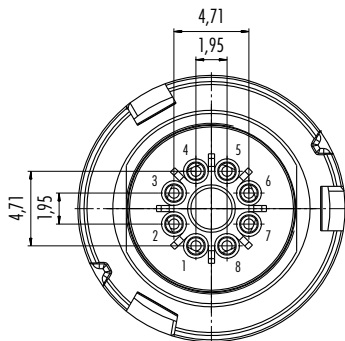

### Contact arrangement female insert (termination side)

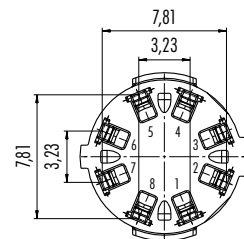

### Panel cut out

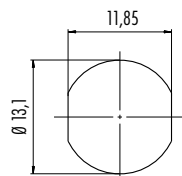



- Push-Pull locking system
- 3 – 19 contacts
- Degree of protection IP40/IP67
- Solder termination
- Diameter 20 mm
- Shieldable

Description	Drawing	Contacts	Cable outlet	Ordering-No.
Male cable connector, shieldable, IP67		3 DIN	4–8 mm	99 4805 00 03
		4		99 4809 00 04
		5		99 4813 00 05
		6 DIN		99 4817 00 06
		7		99 4825 00 07
		8 DIN		99 4829 00 08
		12		99 4833 00 12
		19		99 4841 00 19

Female cable connector, shieldable, IP67		3 DIN	4–8 mm	99 4806 00 03
		4		99 4810 00 04
		5		99 4814 00 05
		6 DIN		99 4818 00 06
		7		99 4826 00 07
		8 DIN		99 4830 00 08
		12		99 4834 00 12
		19		99 4842 00 19

	IP40	IP67	Shielded, IP67	
Male panel mount connector, IP40, IP67, shielded, IP67	3 DIN	09 4807 25 03	09 4807 15 03	09 4807 00 03
	4	09 4811 25 04	09 4811 15 04	09 4811 00 04
	5	09 4815 25 05	09 4815 15 05	09 4815 00 05
	6 DIN	09 4819 25 06	09 4819 15 06	09 4819 00 06
	7	09 4827 25 07	09 4827 15 07	09 4827 00 07
	8 DIN	09 4831 25 08	09 4831 15 08	09 4831 00 08
	12	09 4835 25 12	09 4835 15 12	09 4835 00 12
	19	09 4843 25 19	09 4843 15 19	09 4843 00 19

Male panel mount connector, front fastened, IP67, shielded, IP67	3 DIN	–	09 4807 80 03	09 4807 81 03
	4	–	09 4811 80 04	09 4811 81 04
	5	–	09 4815 80 05	09 4815 81 05
	6 DIN	–	09 4819 80 06	09 4819 81 06
	7	–	09 4827 80 07	09 4827 81 07
	8 DIN	–	09 4831 80 08	09 4831 81 08
	12	–	09 4835 80 12	09 4835 81 12
	19	–	09 4843 80 19	09 4843 81 19

### Specifications

Contacts	3 DIN	4	5	6 DIN	7	8 DIN	12	19	
Wire gauge	max. 0,75 mm <sup>2</sup> (max. AWG 20)						max. 0,25 mm <sup>2</sup> (max. AWG 24)		
Mechanical operation	> 1000 Mating cycles								
Temperature range	– 40 °C / + 85 °C								
Rated voltage <sup>1)</sup>	250 V (32 V)			125 V (32 V)			60 V (32 V)		
Pollution degree	1 (2) <sup>1)</sup>								
Rated current (40°C)	7 A	6 A		5 A			3 A		
Contact plating	Ag (Silver)								
Material of housing	PA GF 25								

### Description

### Drawing

Female panel mount connector, IP40, IP67, shielded, IP67

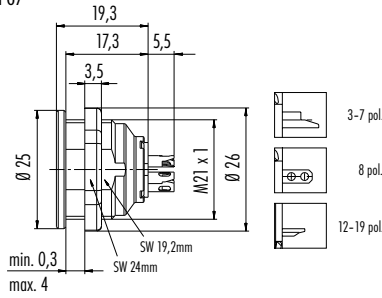

	IP40	IP67	Shielded, IP67
3 DIN	09 4808 25 03	09 4808 15 03	09 4808 00 03
4	09 4812 25 04	09 4812 15 04	09 4812 00 04
5	09 4816 25 05	09 4816 15 05	09 4816 00 05
6 DIN	09 4820 25 06	09 4820 15 06	09 4820 00 06
7	09 4828 25 07	09 4828 15 07	09 4828 00 07
8 DIN	09 4832 25 08	09 4832 15 08	09 4832 00 08
12	09 4836 25 12	09 4836 15 12	09 4836 00 12
19	09 4844 25 19	09 4844 15 19	09 4844 00 19

Female panel mount connector, front fastened, IP67, shielded, IP67

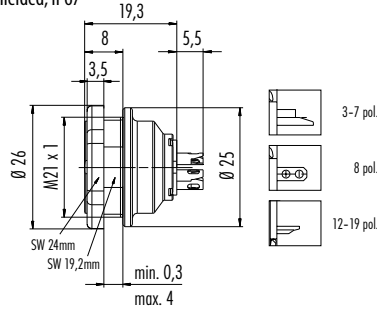

	IP40	IP67	Shielded, IP67
3 DIN	-	09 4808 80 03	09 4808 81 03
4	-	09 4812 80 04	09 4812 81 04
5	-	09 4816 80 05	09 4816 81 05
6 DIN	-	09 4820 80 06	09 4820 81 06
7	-	09 4828 80 07	09 4828 81 07
8 DIN	-	09 4832 80 08	09 4832 81 08
12	-	09 4836 80 12	09 4836 81 12
19	-	09 4844 80 19	09 4844 81 19

### Component part drawing

Cable connectors

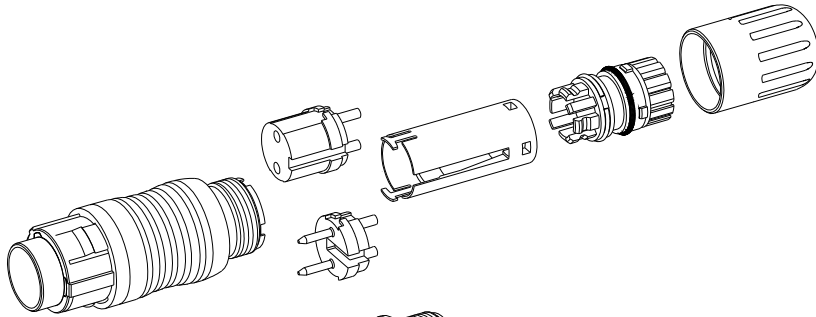

- Locking device
- Male insert
- Female insert
- Distance sleeve
- Clamping device
- Pressing screw

Panel mount connectors

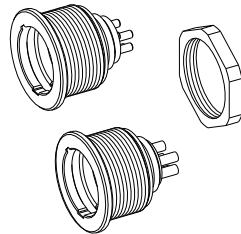

- Panel mount connector housing
- Female insert
- Male insert
- Hexagonal nut

### Contact arrangements male insert (mating side)

3 DIN contacts

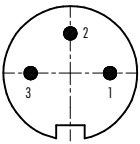

4 contacts

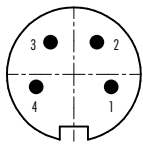

5 contacts

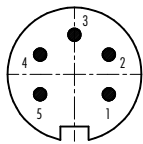

6 DIN contacts

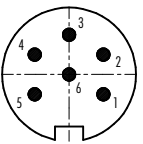

7 contacts

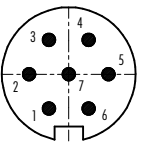

8 DIN contacts

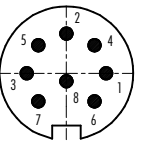

12 contacts

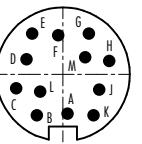

19 contacts

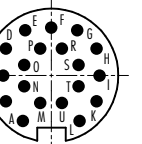

### Contact arrangements female insert (mating side)

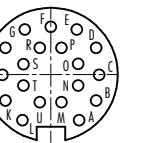
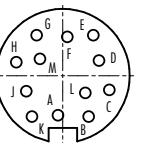
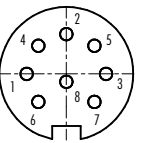
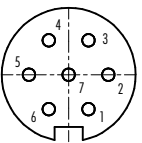
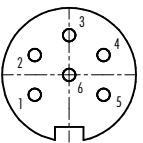
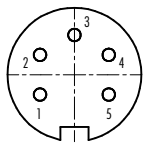
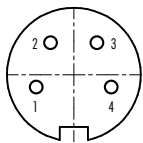
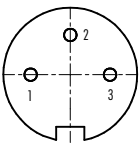

### Panel cut out

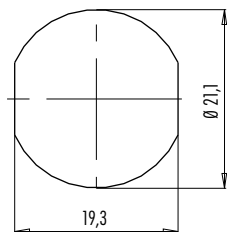

**Description**

Protection cap for cable connectors, IP67

**Drawing**

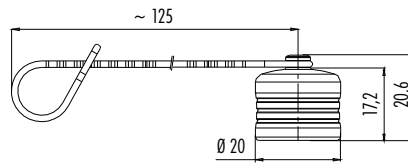

**Ordering-No.**

08 2605 000 001

Protection cap for panel mount connectors, IP67

**Hole-Ø D**

3 mm

**Ordering-No.**

08 2604 000 001

21 mm

08 2679 000 001

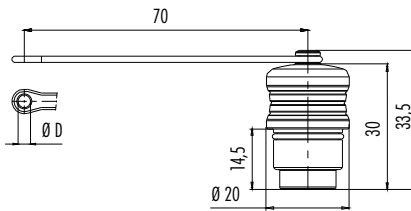

**Ordering-No.**

Protection cap for panel mount connectors, IP40

08 2603 000 000

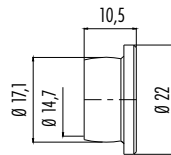

**Cable outlet**

4–6 mm/6–8 mm

**Ordering-No.**

08 2606 000 001

Adapter for a cable-cable connection to mate a panel mount connector

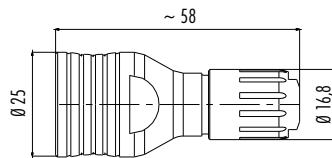

Sealings enclosed loose





- Screw termination M16
- Degree of protection IP40
- Solder-/Crimp-/Screw clamp termination
- Diameter 17,2 mm/17,5mm/18,5 mm/20 mm
- Shieldable versions
- Acc. to DIN EN 61076-2-106

### Description

### Drawing

Male cable connector with solder eye ring, shieldable

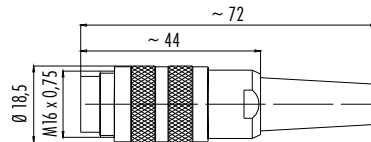

Male cable connector with cable clamp, shieldable

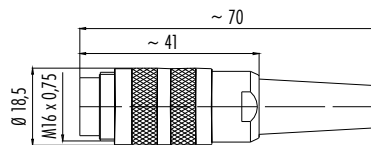

Male cable connector with cable clamp, screw clamp connection, shieldable



Male cable connector with cable clamp, crimp connection, shieldable



Crimp contacts see page 52

### Specifications

Contacts	3 DIN	4	5	6 DIN	7	8 DIN	12	19
Wire gauge	max. 0,75 mm <sup>2</sup> (max. AWG 20)						max. 0,25 mm <sup>2</sup> (max. AWG 24)	
Mechanical operation	> 500 Mating cycles							
Temperature range	- 40 °C / + 85 °C							
Rated voltage <sup>1)</sup>	250 V (32 V)			125 V (32 V)		60 V (32 V)		
Pollution degree	1 (2) <sup>1)</sup>							
Rated current (40°C)	7 A	6 A		5 A			3 A	
Contact plating	Ag (Silver)						Au (Gold)	
Material of housing	CuZn (brass, nickel plated)							

Description	Drawing	Contacts	Cable outlet 4–6 mm	Cable outlet 6–8 mm
Female cable connector with solder eye ring, shieldable		3 DIN	99 2006 00 03	99 2006 02 03
		4	99 2010 00 04	99 2010 02 04
		5	99 2014 00 05	99 2014 02 05
		6 DIN	99 2022 00 06	99 2022 02 06
		7	99 2026 00 07	99 2026 02 07
		8 DIN	99 2062 00 08	99 2062 02 08
		12	99 2030 00 12	99 2030 02 12
		19	99 2042 00 19	99 2042 02 19

Female cable connector with cable clamp, shieldable		3 DIN	99 2006 10 03	99 2006 20 03
		4	99 2010 10 04	99 2010 20 04
		5	99 2014 10 05	99 2014 20 05
		6 DIN	99 2022 10 06	99 2022 20 06
		7	99 2026 10 07	99 2026 20 07
		8 DIN	99 2062 10 08	99 2062 20 08
		12	99 2030 10 12	99 2030 20 12
		19	99 2042 10 19	99 2042 20 19

Female cable connector with cable clamp, screw clamp connection, shieldable		3 DIN	99 2006 210 03	99 2006 220 03
		4	99 2010 210 04	99 2010 220 04
		5	99 2014 210 05	99 2014 220 05

Female cable connector with cable clamp, crimp connection, shieldable		4	99 2010 700 04	99 2010 702 04
		5	99 2014 700 05	99 2014 702 05
		6 DIN	99 2022 700 06	99 2022 702 06
		7	99 2026 700 07	99 2026 702 07
		8 DIN	99 2062 700 08	99 2062 702 08

Crimp contacts see page 52

### Component part drawing

Cable connectors with solder eye ring

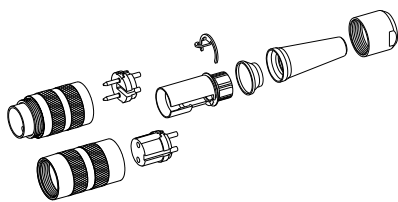

Male ring nut/  
Female ring nut  
Female insert/  
Male insert  
Cable clamp  
Solder eye ring  
Thrust collar  
Cable bushing  
Pressing screw

Cable connectors with cable clamp

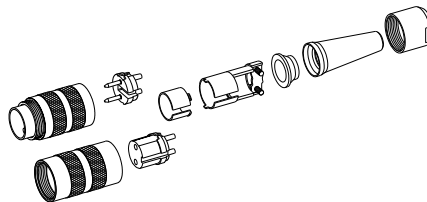

Male ring nut/  
Female ring nut  
Female insert/  
Male insert  
Cable clamp  
Thrust collar  
Cable bushing  
Pressing screw

Cable connectors with screw clamp connection

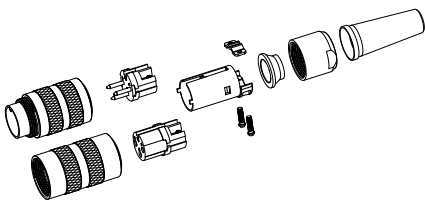

Male ring nut/  
Female ring nut  
Female insert/  
Male insert  
Cable clamp  
Thrust collar  
Pressing screw  
Cable bushing

Cable connectors with crimp connection

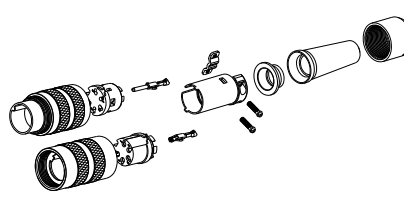

Male ring nut/  
Female ring nut  
Female insert/  
Male insert  
Female contact/  
Male contact  
Cable clamp  
Thrust collar  
Cable bushing  
Pressing screw

Description	Drawing	Contacts	Cable outlet	Ordering-No.
Male cable connector		3 DIN	4-6 mm	09 0305 00 03
		4		09 0309 00 04
		5		09 0313 00 05
		6 DIN		09 0321 00 06
		7		09 0325 00 07
		8 DIN		09 0571 00 08
		12		09 0329 00 12
		19		09 0343 00 19

Male cable connector		3 DIN	6-8 mm	09 0305 02 03
		4		09 0309 02 04
		5		09 0313 02 05
		6 DIN		09 0321 02 06
		7		09 0325 02 07
		8 DIN		09 0571 02 08
		12		09 0329 02 12
		19		09 0343 02 19

Description	Drawing	Contacts	Cable outlet 4-6 mm	Cable outlet 6-8 mm
Male angled connector, plastic version		3 DIN	09 0135 70 03	09 0135 72 03
		4	09 0137 70 04	09 0137 72 04
		5	09 0139 70 05	09 0139 72 05
		6 DIN	09 0143 70 06	09 0143 72 06
		7	09 0145 70 07	09 0145 72 07
		8 DIN	09 0153 70 08	09 0153 72 08
		12	09 0147 70 12	09 0147 72 12
		19	09 0163 70 19	09 0163 72 19

Male angled connector, metal version, shieldable		3 DIN	99 0135 10 03	99 0135 12 03
		4	99 0137 10 04	99 0137 12 04
		5	99 0139 10 05	99 0139 12 05
		6 DIN	99 0143 10 06	99 0143 12 06
		7	99 0145 10 07	99 0145 12 07
		8 DIN	99 0153 10 08	99 0153 12 08
		12	99 0147 10 12	99 0147 12 12
		19	99 0163 10 19	99 0163 12 19

### Component part drawing

Male cable connector

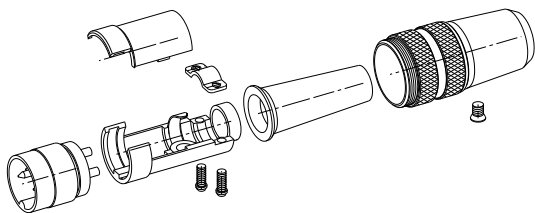

- Male insert
- Carrier sleeve
- Cover
- Fillister head screw
- Strap
- Cable bushing
- Sleeve with coupling ring
- Countersunk head screw

Male angled connector, plastic version

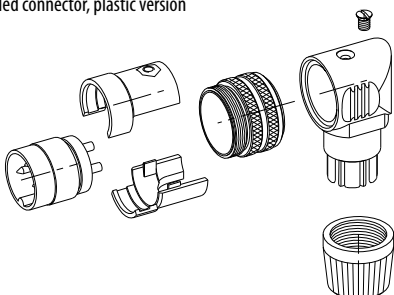

- Male insert
- Carrier sleeve
- Male ring nut
- Angled housing
- Countersunk screw
- Pressing screw
- Cable outlet not adjustable

Male angled connector, metal version

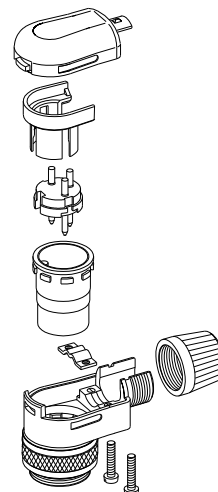

- Male ring nut
- Housing
- Fillister head screw
- Strap
- Pressing screw
- Torsional sleeve
- Male insert
- Distance sleeve
- Cover
- Cable outlet adjustable in 4 positions



Description	Drawing	Contacts	Cable outlet	Ordering-No.
Female cable connector		3 DIN	4-6 mm	09 0306 00 03
		4		09 0310 00 04
		5		09 0314 00 05
		6 DIN		09 0322 00 06
		7		09 0326 00 07
		8 DIN		09 0572 00 08
		12		09 0330 00 12
		19		09 0344 00 19

Female cable connector		3 DIN	6-8 mm	09 0306 02 03
		4		09 0310 02 04
		5		09 0314 02 05
		6 DIN		09 0322 02 06
		7		09 0326 02 07
		8 DIN		09 0572 02 08
		12		09 0330 02 12
		19		09 0344 02 19

Female angled connector, plastic version		Contacts	Cable outlet 4-6 mm	Cable outlet 6-8 mm
		3 DIN	09 0136 70 03	09 0136 72 03
		4	09 0138 70 04	09 0138 72 04
		5	09 0140 70 05	09 0140 72 05
		6 DIN	09 0144 70 06	09 0144 72 06
		7	09 0146 70 07	09 0146 72 07
		8 DIN	09 0154 70 08	09 0154 72 08
		12	09 0148 70 12	09 0148 72 12
		19	09 0166 70 19	09 0164 72 19

Female angled connector, metal version, shieldable		3 DIN	99 0136 10 03	99 0136 12 03
		4	99 0138 10 04	99 0138 12 04
		5	99 0140 10 05	99 0140 12 05
		6 DIN	99 0144 10 06	99 0144 12 06
		7	99 0146 10 07	99 0146 12 07
		8 DIN	99 0154 10 08	99 0154 12 08
		12	99 0148 10 12	99 0148 12 12
		19	99 0164 10 19	99 0164 12 19

## Component part drawing

Female cable connector

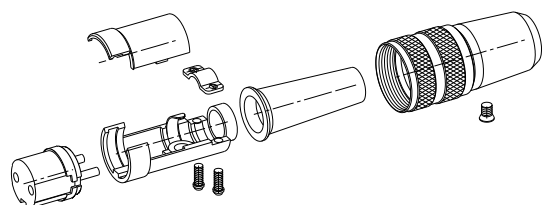

- Female insert
- Carrier sleeve
- Cover
- Fillister head screw
- Strap
- Cable bushing
- Sleeve with coupling ring
- Countersunk head screw

Female angled connector, metal version

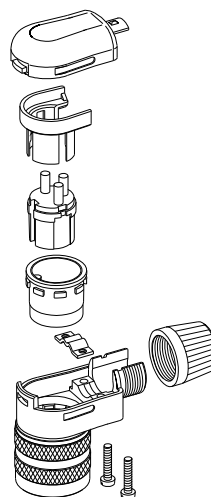





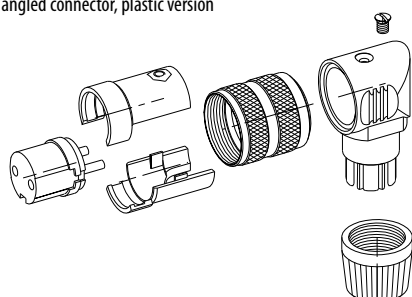



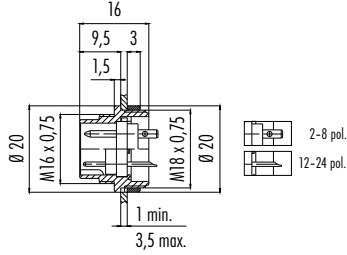

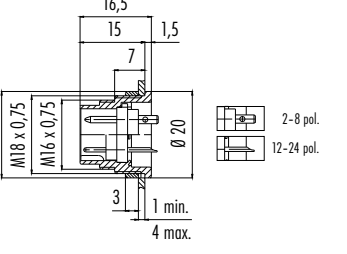
- Female ring nut
- Housing
- Fillister head screw
- Strap
- Pressing screw
- Torsional sleeve
- Female insert
- Distance sleeve
- Cover
- Cable outlet adjustable in 4 positions

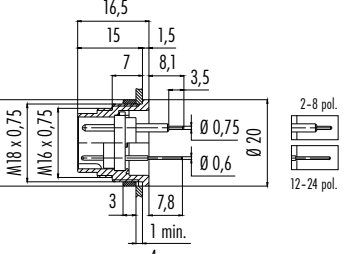
Female angled connector, plastic version

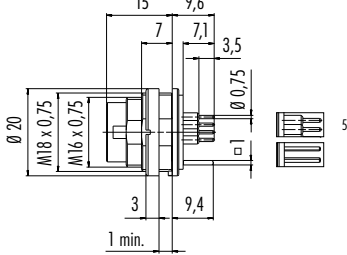

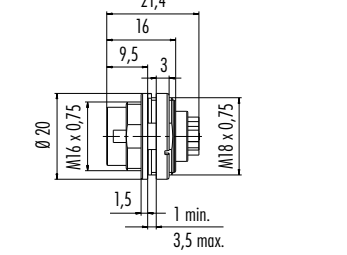
- Female insert
- Carrier sleeve
- Female ring nut
- Angled housing
- Countersunk screw
- Pressing screw
- Cable outlet not adjustable

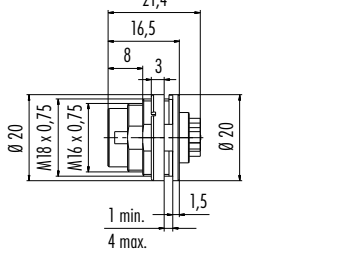
Description	Drawing	Contacts	Ordering-No.
Male panel mount connector, solder 		3 DIN 4 5 6 DIN 7 8 DIN 12 19	09 0307 00 03 09 0311 00 04 09 0315 00 05 09 0323 00 06 09 0327 00 07 09 0473 00 08 09 0331 00 12 09 0335 00 19
Male panel mount connector, solder, front fastened 		3 DIN 4 5 6 DIN 7 8 DIN 12 19	09 0307 80 03 09 0311 80 04 09 0315 80 05 09 0323 80 06 09 0327 80 07 09 0473 80 08 09 0331 80 12 09 0335 80 19
Male panel mount connector, dip-solder, front fastened 		3 DIN 4 5 6 DIN 7 8 DIN 12 19	09 0307 90 03 09 0311 90 04 09 0315 90 05 09 0323 90 06 09 0327 90 07 09 0473 90 08 09 0331 90 12 09 0335 90 19
Male panel mount connector, dip-solder, front fastened, with shield connection 		5 6 DIN 8 DIN 12	09 0315 290 05 09 0323 290 06 09 0473 290 08 09 0331 290 12
Male panel mount connector, crimp 		4 5 6 DIN 7 8 DIN	09 0311 700 04 09 0315 700 05 09 0323 700 06 09 0327 700 07 09 0473 700 08
Male panel mount connector, crimp, front fastened 		4 5 6 DIN 7 8 DIN	09 0311 780 04 09 0315 780 05 09 0323 780 06 09 0327 780 07 09 0473 780 08

**Description**

**Drawing**

**Contacts**

**Ordering-No.**

Male panel mount connector, with single wires (200 mm), AWG 22

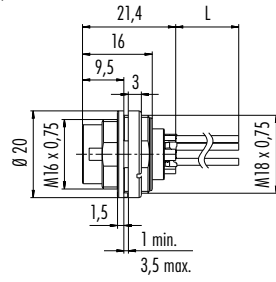

4	09 0311 702 04
5	09 0315 702 05
6 DIN	09 0323 702 06
7	09 0327 702 07
8 DIN	09 0473 702 08

Male panel mount connector, front fastened, with single wires (200 mm), AWG 22

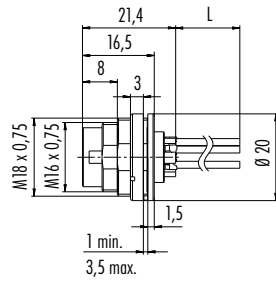

4	09 0311 782 04
5	09 0315 782 05
6 DIN	09 0323 782 06
7	09 0327 782 07
8 DIN	09 0473 782 08

Male panel mount connector with flexible PCB, front fastened

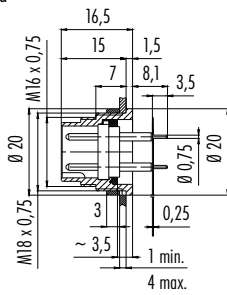

7	09 0327 65 07	
8 DIN	09 0473 65 08	
12	09 0331 65 12	single-row
	09 0331 66 12	double-row

## Description

## Drawing

## Contacts

## Ordering-No.

Female panel mount connector, solder

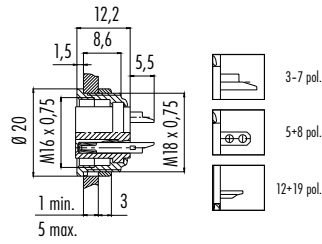

3 DIN	09 0308 00 03
4	09 0312 00 04
5	09 0316 00 05
6 DIN	09 0324 00 06
7	09 0328 00 07
8 DIN	09 0474 00 08
12	09 0332 00 12
19	09 0336 00 19

Female panel mount connector, solder, front fastened

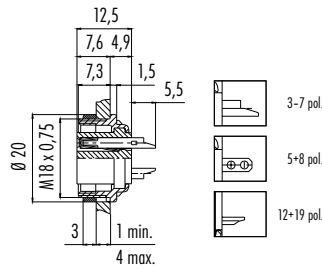

3 DIN	09 0308 80 03
4	09 0312 80 04
5	09 0316 80 05
6 DIN	09 0324 80 06
7	09 0328 80 07
8 DIN	09 0474 80 08
12	09 0332 80 12
19	09 0336 80 19

Female panel mount connector, dip-solder, front fastened

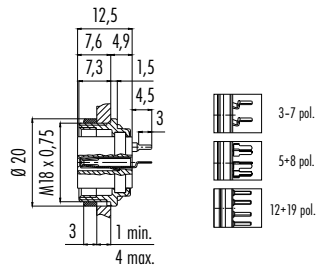

3 DIN	09 0308 90 03
4	09 0312 90 04
5	09 0316 90 05
6 DIN	09 0324 90 06
7	09 0328 90 07
8 DIN	09 0474 90 08
12	09 0332 90 12
19	09 0336 90 19

Female panel mount connector, dip-solder, front fastened, with shield connection

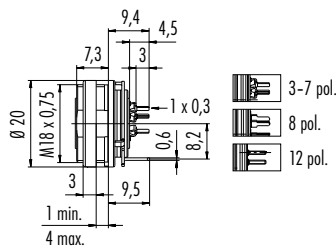

3	09 0308 290 03
4	09 0312 290 04
5	09 0316 290 05
6 DIN	09 0324 290 06
7	09 0328 290 07
8 DIN	09 0474 290 08
12	09 0332 290 12

Female panel mount connector, crimp

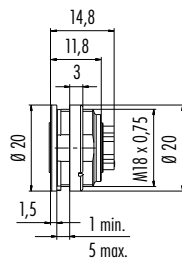

4	09 0312 700 04
5	09 0316 700 05
6 DIN	09 0324 700 06
7	09 0328 700 07
8 DIN	09 0474 700 08

Crimp contacts see page 52

Female panel mount connector, crimp, front fastened

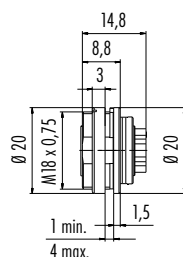

4	09 0312 780 04
5	09 0316 780 05
6 DIN	09 0324 780 06
7	09 0328 780 07
8 DIN	09 0474 780 08

Crimp contacts see page 52

**Description**

**Drawing**

**Contacts**

**Ordering-No.**

Female panel mount connector, with single wires (200 mm), AWG 22

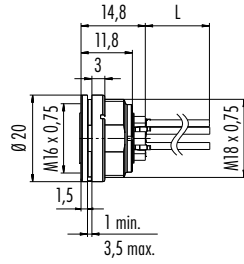

4	09 0312 702 04
5	09 0316 702 05
6 DIN	09 0324 702 06
7	09 0328 702 07
8 DIN	09 0474 702 08

Female panel mount connector, front fastened, with single wires (200 mm), AWG 22

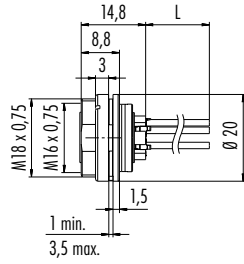

4	09 0312 782 04
5	09 0316 782 05
6 DIN	09 0324 782 06
7	09 0328 782 07
8 DIN	09 0474 782 08

Female panel mount connector with flexible PCB, front fastened

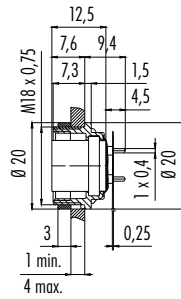

7	09 0328 65 07
8 DIN	09 0474 65 08
12	09 0332 65 12 single-row
	09 0332 66 12 double-row

**Contact arrangements male insert (mating side)**

3 DIN contacts

4 contacts

5 contacts

6 DIN contacts

7 contacts

8 DIN contacts

12 contacts

19 contacts

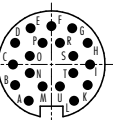
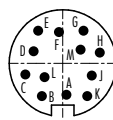
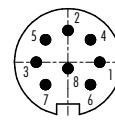
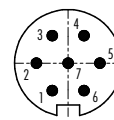
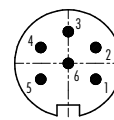
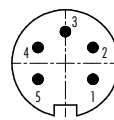
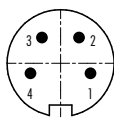
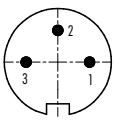

**Contact arrangements female insert (mating side)**

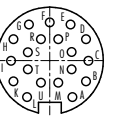
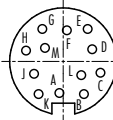
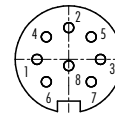
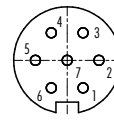
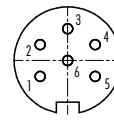
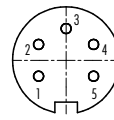
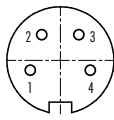
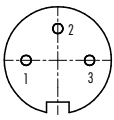

**Panel cut out**

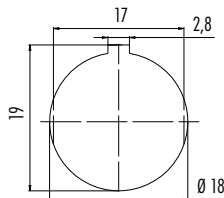

Recommended drill holes for PCBs

2 – 8 contacts	1,1 mm
12 – 24 contacts	0,8 mm

**Colour of wires of panel mount connectors**

- 4–8 contacts
- 1 white
- 2 brown
- 3 green
- 4 yellow
- 5 grey
- 6 pink
- 7 blue
- 8 red

## Description

## Drawing

Single contact (Male), PU 50 pieces

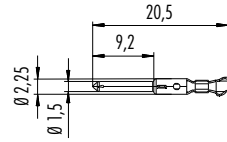

Single contact (Female), PU 50 pieces

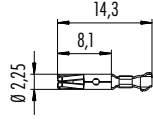

Strip contact (Male)

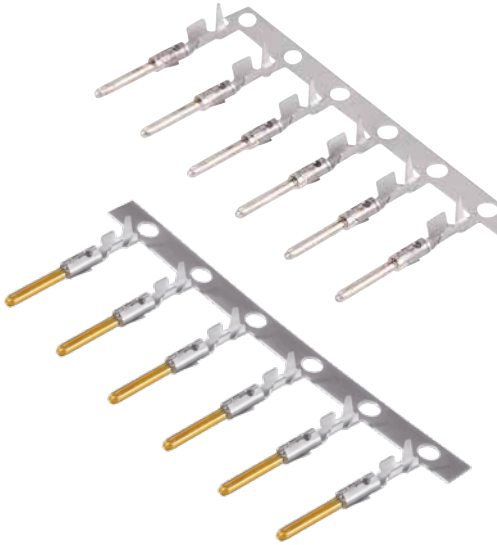





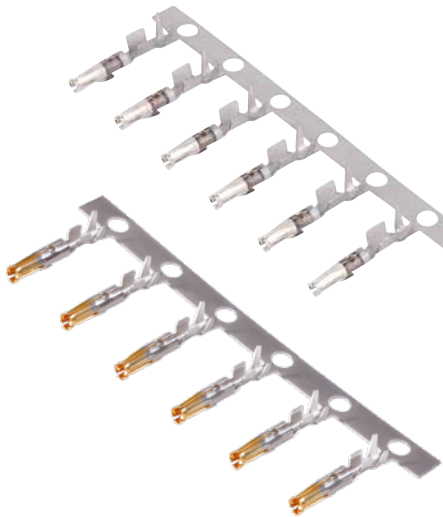



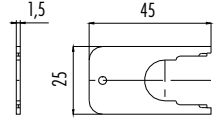

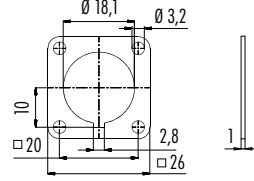

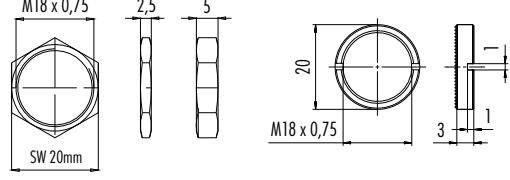

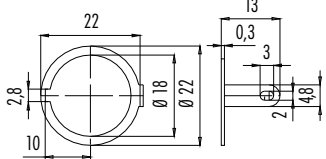

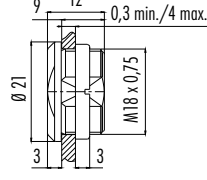

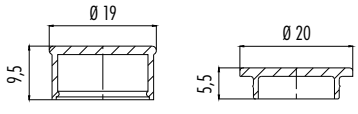
Contact-Ø	Insulating-Ø	Wire gauge	PU	Pieces	Silver	Gold
1,5 mm	1,0–2,0 mm	0,14–0,25 mm <sup>2</sup>	Single	50	61 0799 085 00	61 0799 098 00
			Strip	200	65 0799 085 01	65 0799 098 01
			Strip	2.000	65 0799 085 02	65 0799 098 02
			Strip	4.000	65 0799 085 04	65 0799 098 04
			Strip	10.000	65 0799 085 10	65 0799 098 10
			Strip	10.000	65 0799 085 10	65 0799 098 10
	1,6–2,1 mm	0,35–0,5 mm <sup>2</sup>	Single	50	61 0795 085 00	61 0795 098 00
			Strip	200	65 0795 085 01	65 0795 098 01
			Strip	2.000	65 0795 085 02	65 0795 098 02
			Strip	4.000	65 0795 085 04	65 0795 098 04
			Strip	10.000	65 0795 085 10	65 0795 098 10
			Strip	10.000	65 0795 085 10	65 0795 098 10

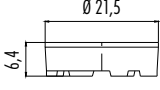
Strip contact (Female)

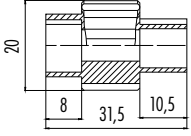

1,5 mm	1,0–2,0 mm	0,14–0,25 mm <sup>2</sup>	Single	50	61 0800 085 00	61 0800 098 00
			Strip	200	65 0800 085 01	65 0800 098 01
			Strip	2.000	65 0800 085 02	65 0800 098 02
			Strip	4.000	65 0800 085 04	65 0800 098 04
			Strip	10.000	65 0800 085 10	65 0800 098 10
			Strip	10.000	65 0800 085 10	65 0800 098 10
	1,6–2,1 mm	0,35–0,5 mm <sup>2</sup>	Single	50	61 0797 085 00	61 0797 098 00
			Strip	200	65 0797 085 01	65 0797 098 01
			Strip	2.000	65 0797 085 02	65 0797 098 02
			Strip	4.000	65 0797 085 04	65 0797 098 04
			Strip	10.000	65 0797 085 10	65 0797 098 10
			Strip	10.000	65 0797 085 10	65 0797 098 10

Description	Drawing	Ordering-No.
Mounting spanner for panel mount connectors 		07 0010 001
Rectangular flange for panel mount connectors 		04 0106 001  <b>Thickness</b> <b>Ordering-No.</b> 2,5 mm            01 0146 001    Hexagonal nut 5 mm              01 5006 001    Hexagonal nut -                    01 0010 001    Ring nut with knurled screw
Hexagonal nut/Ring nut for fixing thread 		<b>Ordering-No.</b> 04 0183 009
Solder eye ring 		<b>Height</b> <b>Ordering-No.</b> 12 mm              08 2668 000 001
Blind plug 		02 0054 000 02 0055 001 02 0055 000    black
Protection cap for panel mount connectors, IP40 		02 0007 000
Distance sleeve for panel mount connectors, dip-solder version 	 PCB thickness: max. 1,5 mm	02 0007 000
Mounting spanner for straight, shieldable cable connectors 		02 1785 000  66 0001 014 100 67 0001 014 100
Crimping tool for single contacts 	Crimping tool for strip contacts 	07 0090 000
Extraction tool for crimp contacts 		07 0090 000



- Screw termination M16
- Degree of protection IP67
- Solder-/Crimp-/Screw clamp termination
- Moulded versions
- shieldable
- Acc. to DIN EN 61076-2-106
- AISG compatible

**certified under number 20120329-E30 2391**

Description	Drawing	Contacts	Cable outlet	Shielding ring	Cable clamp
Male cable connector with shielding ring/cable clamp, shieldable, solder termination		3 DIN	4-6 mm	99 5105 15 03	99 5105 00 03
		4		99 5109 15 04	99 5109 00 04
		5		99 5113 15 05	99 5113 00 05
		6 DIN		99 5121 15 06	99 5121 00 06
		7		99 5125 15 07	99 5125 00 07
		8 DIN		99 5171 15 08	99 5171 00 08
		12		99 5129 15 12	99 5129 00 12
		19		99 5461 15 19	99 5461 00 19

Male cable connector with shielding ring/cable clamp, shieldable, solder termination		3 DIN	6-8 mm	99 5605 15 03	99 5605 00 03
		4		99 5609 15 04	99 5609 00 04
		5		99 5613 15 05	99 5613 00 05
		6 DIN		99 5621 15 06	99 5621 00 06
		7		99 5625 15 07	99 5625 00 07
		8 DIN		99 5671 15 08	99 5671 00 08
		12		99 5629 15 12	99 5629 00 12
		19		99 5661 15 19	99 5661 00 19

Description	Drawing	Contacts	Cable outlet	Screw clamp	Crimp
Male cable connector with cable clamp, screw clamp connection/crimp connection, shieldable		3 DIN	4-6 mm	99 5105 210 03	-
		4		99 5109 210 04	99 5109 700 04
		5		99 5113 210 05	99 5113 700 05
		6 DIN		-	99 5121 700 06
		7		-	99 5125 700 07
		8 DIN		-	99 5171 700 08

Crimp contacts see page 63

Male cable connector with cable clamp, screw clamp connection/crimp connection, shieldable		3 DIN	6-8 mm	99 5605 210 03	-
		4		99 5609 210 04	99 5609 700 04
		5		99 5613 210 05	99 5613 700 05
		6 DIN		-	99 5621 700 06
		7		-	99 5625 700 07
		8 DIN		-	99 5671 700 08

Crimp contacts see page 63

### Specifications

Contacts	3 DIN	4	5	6 DIN	7	8 DIN	12	19	
Wire gauge	max. 0,75 mm <sup>2</sup> (max. AWG 20)						max. 0,25 mm <sup>2</sup> (max. AWG 24)		
Mechanical operation	> 500 Mating cycles								
Temperature range	- 40 °C / + 95 °C								
Rated voltage <sup>1)</sup>	250 V (32 V)				125 V (32 V)		60 V (32 V)		
Pollution degree	1 (2) <sup>1)</sup>								
Rated current (40°C)	7 A	6 A			5 A			3 A	
Contact plating	Ag (Silver)						Au (Gold)		
Material of housing	CuZn (brass, nickel plated)								



**Description**

**Drawing**

**Contacts**

**Cable outlet**

**Ordering-No.**

Male cable connector, short version, solder termination

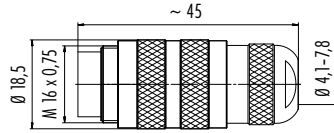

3 DIN	4-8 mm	99 5105 40 03
4		99 5109 40 04
5		99 5113 40 05
6 DIN		99 5121 40 06
7		99 5125 40 07
8 DIN		99 5171 40 08
12		99 5129 40 12
19		99 5461 40 19

Male cable connector, short version, crimp connection



4	4-8 mm	99 5109 74 04
5		99 5113 74 05
6 DIN		99 5121 74 06
7		99 5125 74 07
8 DIN		99 5171 74 08

Crimp contacts see page 63

Male angled connector, shieldable, solder termination

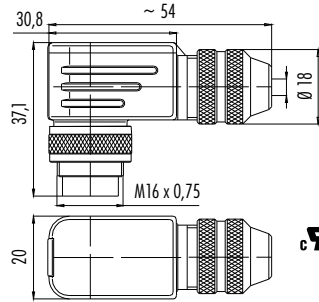

Contacts	Cable outlet 4-6 mm	Cable outlet 6-8 mm
3 DIN	99 5105 75 03	99 5605 75 03
4	99 5109 75 04	99 5609 75 04
5	99 5113 75 05	99 5613 75 05
6 DIN	99 5121 75 06	99 5621 75 06
7	99 5125 75 07	99 5625 75 07
8 DIN	99 5171 75 08	99 5671 75 08
12	99 5129 75 12	99 5629 75 12
19	99 5461 75 19	99 5661 75 19

Male angled connector, shieldable, crimp connection



4	99 5109 75 04	99 5609 75 04
5	99 5113 75 05	99 5613 75 05
6 DIN	99 5121 75 06	99 5621 75 06
7	99 5125 75 07	99 5625 75 07
8 DIN	99 5171 75 08	99 5671 75 08

Crimp contacts see page 63

Male cable connector, moulded

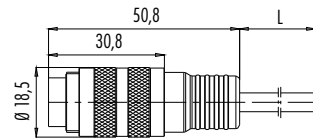

Contacts	Cable length, PUR	Unshielded	Shielded
5 x 0,25	2 m	79 6013 20 05	79 6113 20 05
6 DIN x 0,25		-	79 6117 20 06
8 DIN x 0,25		79 6071 20 08	79 6171 20 08
12 x 0,25		79 6029 20 12	79 6129 20 12

Male angled connector, moulded

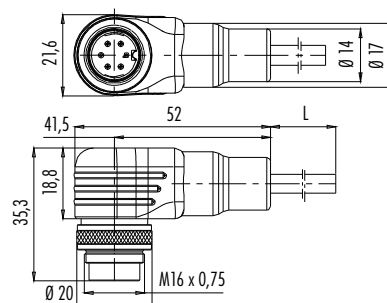

5 x 0,25	2 m	79 6213 200 05	79 6313 200 05
6 DIN x 0,25		-	79 6317 200 06
8 DIN x 0,25		79 6271 200 08	79 6371 200 08
12 x 0,25		79 6229 200 12	79 6329 200 12

Description	Drawing	Contacts	Cable outlet	Shielding ring	cable clamp
Female cable connector with shielding ring/cable clamp, shieldable		3 DIN	4-6 mm	99 5106 15 03	99 5106 00 03
		4		99 5110 15 04	99 5110 00 04
		5		99 5114 15 05	99 5114 00 05
		6 DIN		99 5122 15 06	99 5122 00 06
		7		99 5126 15 07	99 5126 00 07
		8 DIN		99 5172 15 08	99 5172 00 08
		12		99 5130 15 12	99 5130 00 12
		19		99 5462 15 19	99 5462 00 19

Female cable connector with shielding ring/cable clamp, shieldable		3 DIN	6-8 mm	99 5606 15 03	99 5606 00 03
		4		99 5610 15 04	99 5610 00 04
		5		99 5614 15 05	99 5614 00 05
		6 DIN		99 5622 15 06	99 5622 00 06
		7		99 5626 15 07	99 5626 00 07
		8 DIN		99 5672 15 08	99 5672 00 08
		12		99 5630 15 12	99 5630 00 12
		19		99 5662 15 19	99 5662 00 19

Description	Drawing	Contacts	Cable outlet	Screw clamp	Crimp
Female cable connector with cable clamp, screw clamp connection/crimp connection, shieldable		3 DIN	4-6 mm	99 5106 210 03	-
		4		99 5110 210 04	99 5110 700 04
		5		99 5114 210 05	99 5114 700 05
		6 DIN		-	99 5122 700 06
		7		-	99 5126 700 07
		8 DIN		-	99 5172 700 08

Crimp contacts see page 63

Female cable connector with cable clamp, screw clamp connection/crimp connection, shieldable		3 DIN	6-8 mm	99 5606 210 03	-
		4		99 5610 210 04	99 5610 700 04
		5		99 5614 210 05	99 5614 700 05
		6 DIN		-	99 5622 700 06
		7		-	99 5626 700 07
		8 DIN		-	99 5672 700 08

Description	Drawing	Contacts	Cable outlet	Ordering-No.
Female cable connector, short version, solder termination		3 DIN	4-8 mm	99 5106 40 03
		4		99 5110 40 04
		5		99 5114 40 05
		6 DIN		99 5122 40 06
		7		99 5126 40 07
		8 DIN		99 5172 40 08
		12		99 5130 40 12
		19		99 5462 40 19

Female cable connector, short version, crimp connection		4	4-8 mm	99 5110 740 04
		5		99 5114 740 05
		6 DIN		99 5122 740 06
		7		99 5126 740 07
		8 DIN		99 5172 740 08

Crimp contacts see page 63

**Description**

Female angled connector, shieldable



**Drawing**

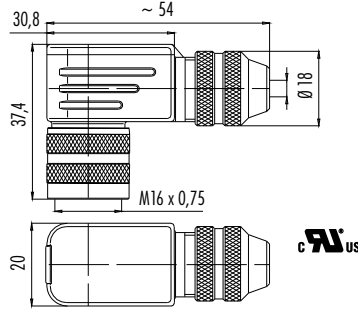

**Contacts**

**Cable outlet 4–6 mm**

**Cable outlet 6–8 mm**

3 DIN	99 5106 75 03	99 5606 75 03
4	99 5110 75 04	99 5610 75 04
5	99 5114 75 05	99 5614 75 05
6 DIN	99 5122 75 06	99 5622 75 06
7	99 5126 75 07	99 5626 75 07
8 DIN	99 5172 75 08	99 5672 75 08
12	99 5130 75 12	99 5630 75 12
19	99 5462 75 19	99 5662 75 19

Female angled connector, crimp connection, shieldable



4	99 5110 75 04	99 5610 75 04
5	99 5114 75 05	99 5614 75 05
6 DIN	99 5122 75 06	99 5622 75 06
7	99 5126 75 07	99 5626 75 07
8 DIN	99 5172 75 08	99 5672 75 08

Crimp contacts see page 63

Female cable connector, moulded

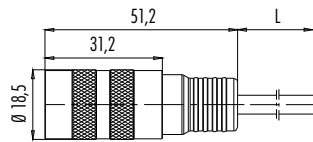

Contacts	Cable length, PUR	Unshielded	Shielded
5 x 0,25	2 m	79 6014 20 05	79 6114 20 05
6 DIN x 0,25		–	79 6118 20 06
8 DIN x 0,25		79 6072 20 08	79 6172 20 08
12 x 0,25		79 6030 20 12	79 6130 20 12

Female angled connector, moulded

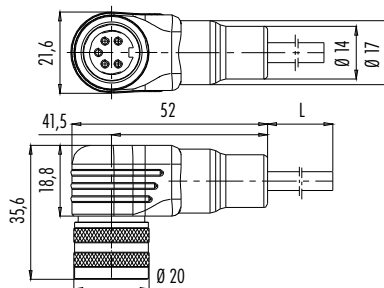

5 x 0,25	2 m	79 6214 200 05	79 6314 200 05
6 DIN x 0,25		–	79 6318 200 06
8 DIN x 0,25		79 6272 200 08	79 6372 200 08
12 x 0,25		79 6230 200 12	79 6330 200 12

**Component part drawing**

Cable connectors, solder termination, with shielding ring

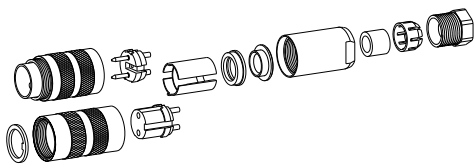

- Male ring nut/
- Female ring nut with seal
- Female insert/
- Male insert
- Distance sleeve
- Shielding ring
- Shield clamping ring
- Sleeve
- Seal
- Pinch ring
- Pressing screw

Cable connectors, solder termination, with cable clamp

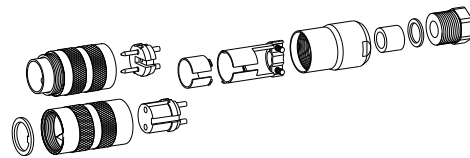

- Male ring nut/
- Female ring nut with seal
- Female insert/
- Male insert
- Cable clamp
- Sleeve
- Seal
- Thrust collar
- Pressing screw

Cable connectors with screw clamp connection

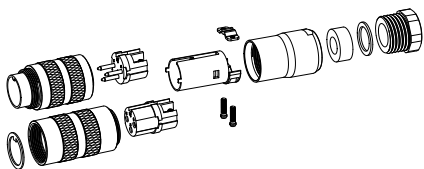

- Male ring nut/
- Female ring nut with seal
- Female insert/
- Male insert
- Cable clamp
- Sleeve
- Seal
- Thrust collar
- Pressing screw

Cable connectors with crimp connection

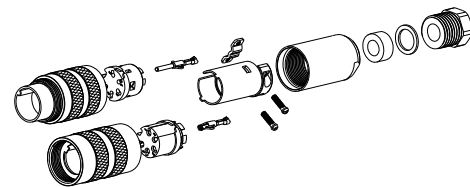

- Male ring nut/
- Female ring nut
- Female insert/
- Male insert
- Female contact/
- Male contact
- Cable clamp
- Sleeve
- Seal
- Thrust collar
- Pressing screw

## Component part drawing

Cable connectors, short version

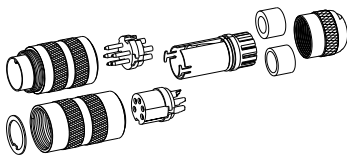

Male ring nut/  
Female ring nut with seal  
Female insert/  
Male insert  
Cable clamp  
Seal 4–6 mm/6–8 mm  
Pressing screw

Angled connectors

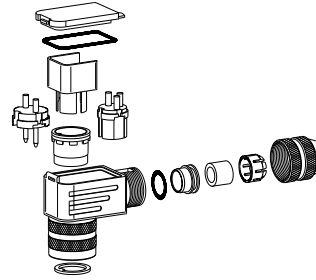

Male ring nut and housing/  
Female ring nut and housing with seal  
Positioning sleeve with O-ring 12,5 x 1,1  
Female insert/  
Male insert  
Distance sleeve, Shaped seal, Cover  
O-ring 9 x 1,5  
Shielding ring, Seal  
Pinch ring, Pressing screw  
Cable outlet adjustable in 4 positions

## Description

## Drawing

Male cable connector, solder termination

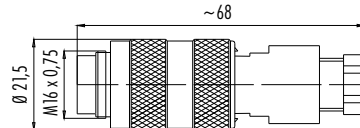

## Contacts

## Cable outlet 4–6 mm

## Cable outlet 6–8 mm

3 DIN	09 0105 25 03	09 0105 70 03
4	09 0109 25 04	09 0109 70 04
5	09 0113 25 05	09 0113 70 05
6 DIN	09 0121 25 06	09 0121 70 06
7	09 0125 25 07	09 0125 70 07
8 DIN	09 0171 25 08	09 0171 70 08
12	09 0129 25 12	09 0129 70 12
19	09 0461 25 19	09 0461 70 19

Male angled connector, solder termination

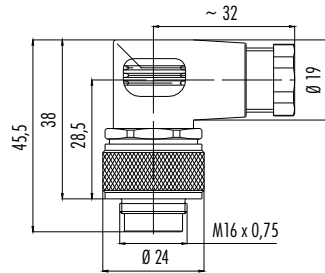

3 DIN	99 0105 106 03	99 0105 75 03
4	99 0109 106 04	99 0109 75 04
5	99 0113 106 05	99 0113 75 05
6 DIN	99 0121 106 06	99 0121 75 06
7	99 0125 106 07	99 0125 75 07
8 DIN	99 0171 106 08	99 0171 75 08
12	99 0129 106 12	99 0129 75 12
19	99 0461 106 19	99 0461 75 19

Female cable connector, solder termination

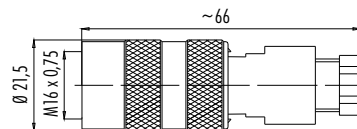

3 DIN	09 0106 25 03	09 0106 70 03
4	09 0110 25 04	09 0110 70 04
5	09 0114 25 05	09 0114 70 05
6 DIN	09 0122 25 06	09 0122 70 06
7	09 0126 25 07	09 0126 70 07
8 DIN	09 0172 25 08	09 0172 70 08
12	09 0130 25 12	09 0130 70 12
19	09 0462 25 19	09 0462 70 19

Female angled connector, solder termination

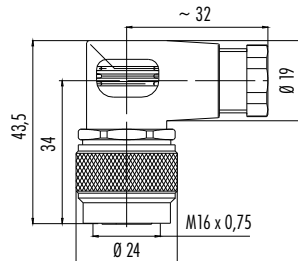

3 DIN	99 0106 106 03	99 0106 75 03
4	99 0110 106 04	99 0110 75 04
5	99 0114 106 05	99 0114 75 05
6 DIN	99 0122 106 06	99 0122 75 06
7	99 0126 106 07	99 0126 75 07
8 DIN	99 0172 106 08	99 0172 75 08
12	99 0130 106 12	99 0130 75 12
19	99 0462 106 19	99 0462 75 19

## Component part drawing

Cable connectors

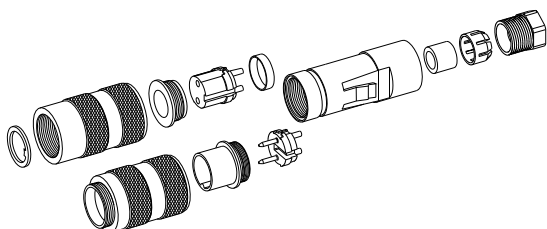

Male ring nut/  
Female ring nut with seal  
Female insert assembled/  
Male insert assembled  
Housing  
Seal  
Pinch ring  
Pressing screw

Angled connectors

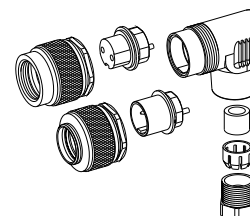

Male ring nut/  
Female ring nut  
Female insert/  
Male insert  
Angled housing  
Seal  
Pinch ring  
Pressing screw  
Cable outlet adjustable in 4 positions



## Description

Male panel mount connector, rectangular flange, crimp

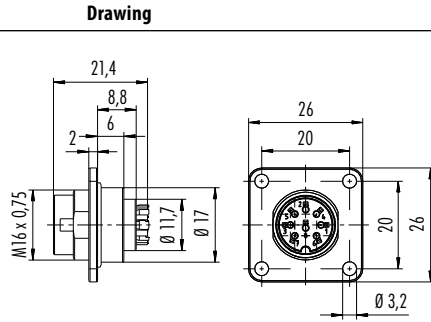

Crimp contacts see page 63

Male panel mount connector, crimp, front fastened

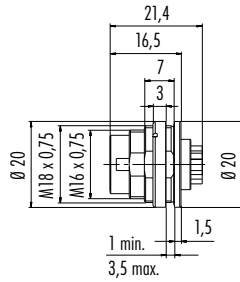

Crimp contacts see page 63

Male panel mount connector, with single wires (200 mm), AWG 22

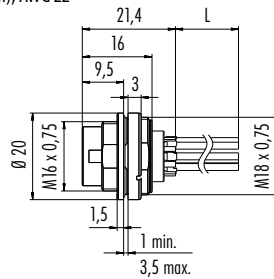

Male panel mount connector, front fastened, with single wires (200 mm), AWG 22

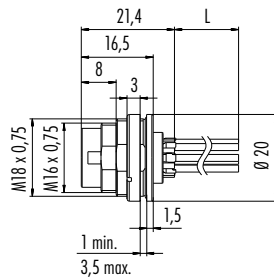

Male panel mount connector, rectangular flange, with single wires (200 mm), AWG 22

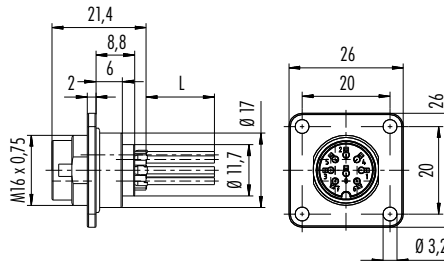

Male panel mount connector with flexible PCB, front fastened

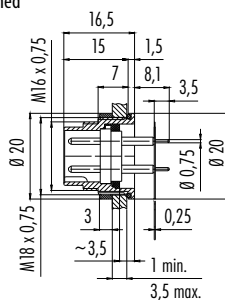

## Contacts

## Ordering-No.

4	09 0111 370 04
5	09 0115 370 05
6 DIN	09 0123 370 06
7	09 0127 370 07
8 DIN	09 0173 370 08



4	09 0111 780 04
5	09 0115 780 05
6 DIN	09 0123 780 06
7	09 0127 780 07
8 DIN	09 0173 780 08



4	09 0111 702 04
5	09 0115 702 05
6 DIN	09 0123 702 06
7	09 0127 702 07
8 DIN	09 0173 702 08



4	09 0111 782 04
5	09 0115 782 05
6 DIN	09 0123 782 06
7	09 0127 782 07
8 DIN	09 0173 782 08



4	09 0111 320 04
5	09 0115 320 05
6 DIN	09 0123 320 06
7	09 0127 320 07
8 DIN	09 0173 320 08



7	09 0127 65 07
8 DIN	09 0173 65 08
12	09 0131 65 12 single-row
	09 0131 66 12 double-row

Description	Drawing	Contacts	Ordering-No.
Female panel mount connector, solder		3 DIN	09 0108 00 03
		4	09 0112 00 04
		5	09 0116 00 05
		6 DIN	09 0124 00 06
		7	09 0128 00 07
		8 DIN	09 0174 00 08
		12	09 0132 00 12
		19	09 0464 00 19

Female panel mount connector, rectangular flange, solder		2	09 0104 300 02
		3 DIN	09 0108 300 03
		4	09 0112 300 04
		5	09 0116 300 05
		6 DIN	09 0124 300 06
		7	09 0128 300 07
		8 DIN	09 0174 300 08
		12	09 0132 300 12
		14	09 0454 300 14
		16	09 0508 300 16
		19	09 0464 300 19

Female panel mount connector, solder, front fastened		3 DIN	09 0108 80 03
		4	09 0112 80 04
		5	09 0116 80 05
		6 DIN	09 0124 80 06
		7	09 0128 80 07
		8 DIN	09 0174 80 08
		12	09 0132 80 12
		19	09 0464 80 19

Female panel mount connector, dip-solder, front fastened		3 DIN	09 0108 90 03
		4	09 0112 90 04
		5	09 0116 90 05
		6 DIN	09 0124 90 06
		7	09 0128 90 07
		8 DIN	09 0174 90 08
		12	09 0132 90 12
		19	09 0464 90 19

Female panel mount connector, dip-solder, front fastened, with shield connection		3	09 0108 290 03		
		4	09 0112 290 04		
		5	09 0116 290 05		
		6 DIN	09 0124 290 06		
		7	09 0128 290 07		
		8 DIN	09 0174 290 08		
		12	09 0132 290 12		

**NEW**

Female panel mount connector, crimp		4	09 0112 700 04		
		5	09 0116 700 05		
		6 DIN	09 0124 700 06		
		7	09 0128 700 07		
		8 DIN	09 0174 700 08		

Crimp contacts see page 63

**Description**

**Drawing**

**Contacts**

**Ordering-No.**

Female panel mount connector, rectangular flange, crimp

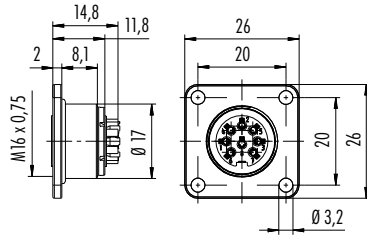

4	09 0112 370 04
5	09 0116 370 05
6 DIN	09 0124 370 06
7	09 0128 370 07
8 DIN	09 0174 370 08

Crimp contacts see page 63



Female panel mount connector, crimp, front fastened

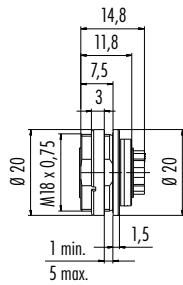

4	09 0112 780 04
5	09 0116 780 05
6 DIN	09 0124 780 06
7	09 0128 780 07
8 DIN	09 0174 780 08

Crimp contacts see page 63



Female panel mount connector, with single wires (200 mm), AWG 22

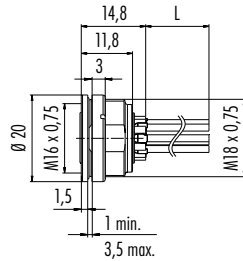

4	09 0112 702 04
5	09 0116 702 05
6 DIN	09 0124 702 06
7	09 0128 702 07
8 DIN	09 0174 702 08



Female panel mount connector, front fastened, with single wires (200 mm), AWG 22

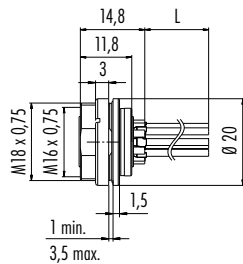

4	09 0112 782 04
5	09 0116 782 05
6 DIN	09 0124 782 06
7	09 0128 782 07
8 DIN	09 0174 782 08



Female panel mount connector, rectangular flange, with single wires (200 mm), AWG 22

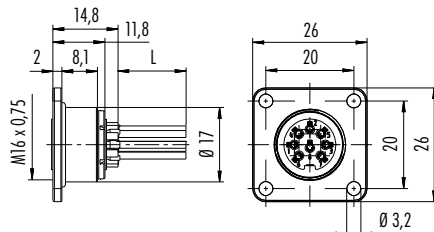
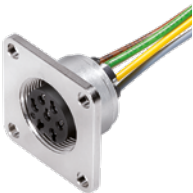

4	09 0112 320 04
5	09 0116 320 05
6 DIN	09 0124 320 06
7	09 0128 320 07
8 DIN	09 0174 320 08



Female panel mount connector with flexible PCB, front fastened

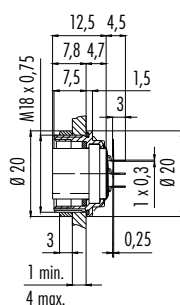

7	09 0128 65 07
8 DIN	09 0174 65 08
12	09 0132 65 12 single-row
	09 0132 66 12 double-row



### Contact arrangements male insert (mating side)

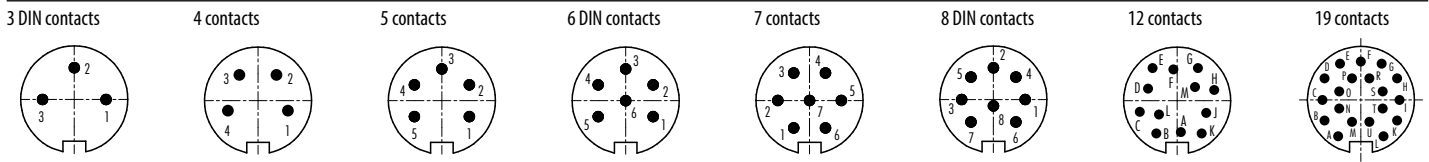

### Contact arrangements female insert (mating side)

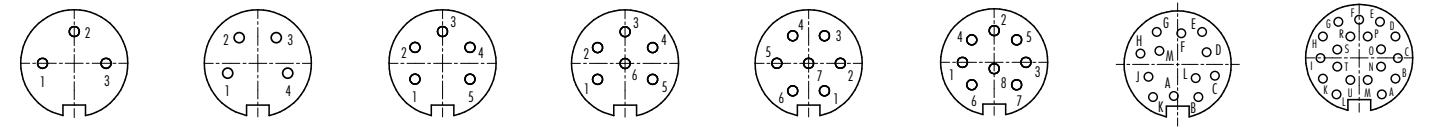

### Panel cut out

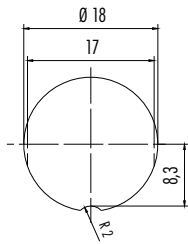

Recommended drill holes for PCBs

2 – 8 contacts 1,1 mm  
12 – 24 contacts 0,8 mm

### Colour of wires of moulded cable connectors

5 contacts	6 contacts	8 contacts	12 contacts
1 white	1 red	1 white	A white
2 brown	2 black	2 brown	B brown
3 blue	3 yellow	3 green	C green
4 black	4 blue	4 yellow	D yellow
5 grey	5 white	5 grey	E grey
	6 green	6 pink	F pink
		7 blue	G blue
		8 red	H red

### Colour of wires of panel mount connectors

4–8 contacts
1 white
2 brown
3 green
4 yellow
5 grey
6 pink
7 blue
8 red

### Description

### Drawing

Single contact (Male), PU 50 pieces

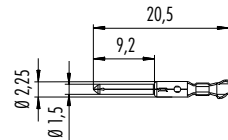

Single contact (Female), PU 50 pieces

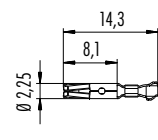

Strip contact (Male)

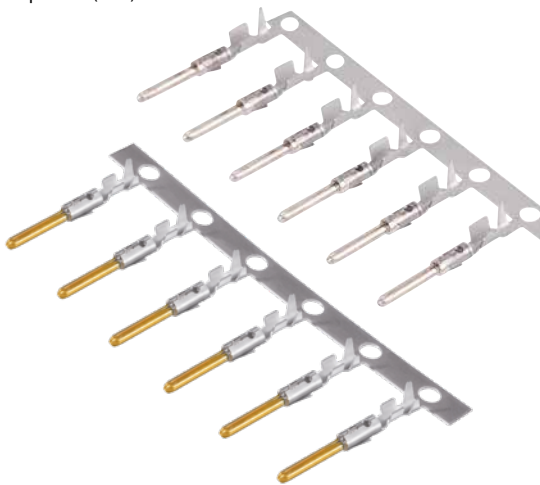

Contact-Ø	Insulating-Ø	Wire gauge	PU	Pieces	Silver	Gold
1,0–2,0 mm	0,14–0,25 mm <sup>2</sup>	1,0–2,0 mm	Single	50	61 0799 085 00	61 0799 098 00
			Strip	200	65 0799 085 01	65 0799 098 01
			Strip	2.000	65 0799 085 02	65 0799 098 02
			Strip	4.000	65 0799 085 04	65 0799 098 04
			Strip	10.000	65 0799 085 10	65 0799 098 10
			Strip	10.000	65 0799 085 10	65 0799 098 10
	1,5 mm	0,35–0,5 mm <sup>2</sup>	Single	50	61 0795 085 00	61 0795 098 00
			Strip	200	65 0795 085 01	65 0795 098 01
			Strip	2.000	65 0795 085 02	65 0795 098 02
			Strip	4.000	65 0795 085 04	65 0795 098 04
			Strip	10.000	65 0795 085 10	65 0795 098 10
			Strip	10.000	65 0795 085 10	65 0795 098 10
1,6–2,1 mm	0,75–1,0 mm <sup>2</sup>	Single	50	61 0796 085 00	61 0796 098 00	
		Strip	200	65 0796 085 01	65 0796 098 01	
		Strip	2.000	65 0796 085 02	65 0796 098 02	
		Strip	4.000	65 0796 085 04	65 0796 098 04	
		Strip	10.000	65 0796 085 10	65 0796 098 10	
		Strip	10.000	65 0796 085 10	65 0796 098 10	

Strip contact (Female)

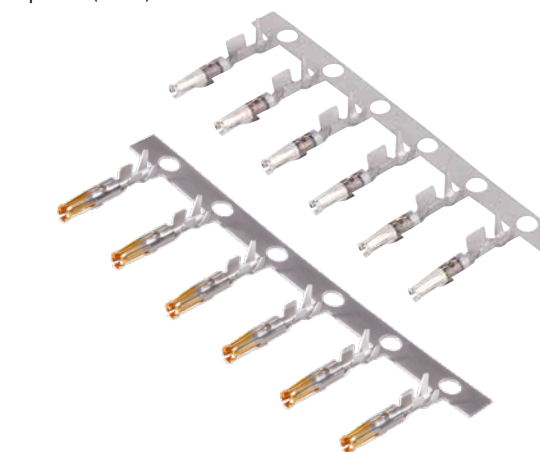

1,0–2,0 mm	0,14–0,25 mm <sup>2</sup>	1,0–2,0 mm	Single	50	61 0800 085 00	61 0800 098 00
			Strip	200	65 0800 085 01	65 0800 098 01
			Strip	2.000	65 0800 085 02	65 0800 098 02
			Strip	4.000	65 0800 085 04	65 0800 098 04
			Strip	10.000	65 0800 085 10	65 0800 098 10
			Strip	10.000	65 0800 085 10	65 0800 098 10
	1,5 mm	0,35–0,5 mm <sup>2</sup>	Single	50	61 0797 085 00	61 0797 098 00
			Strip	200	65 0797 085 01	65 0797 098 01
			Strip	2.000	65 0797 085 02	65 0797 098 02
			Strip	4.000	65 0797 085 04	65 0797 098 04
			Strip	10.000	65 0797 085 10	65 0797 098 10
			Strip	10.000	65 0797 085 10	65 0797 098 10
1,6–2,1 mm	0,75–1,0 mm <sup>2</sup>	Single	50	61 0798 085 00	61 0798 098 00	
		Strip	200	65 0798 085 01	65 0798 098 01	
		Strip	2.000	65 0798 085 02	65 0798 098 02	
		Strip	4.000	65 0798 085 04	65 0798 098 04	
		Strip	10.000	65 0798 085 10	65 0798 098 10	
		Strip	10.000	65 0798 085 10	65 0798 098 10	

**Description**

**Drawing**

**Ordering-No.**

Protection cap for male cable connectors

08 1077 000 000

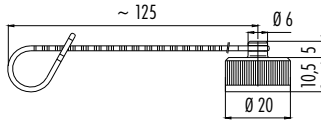

Protection cap for female cable connectors

08 1078 000 000

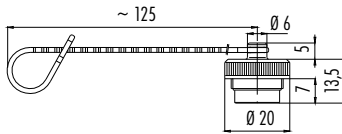

Protection cap for male panel mount connectors

**Hole-Ø D**

**Ordering-No.**

3 mm 08 1079 000 000

18 mm 08 2670 000 000

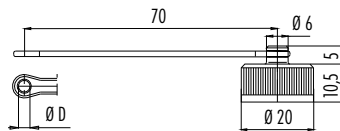

Protection cap for female panel mount connectors

3 mm 08 1080 000 000

18 mm 08 2671 000 000

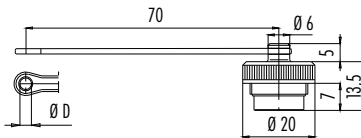

**Ordering-No.**

Mounting spanner for panel mount connectors

07 0010 001

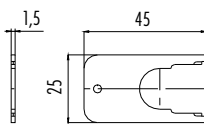

Rectangular flange for panel mount connectors



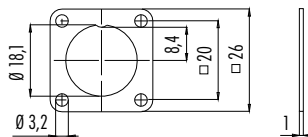





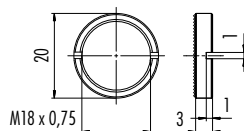

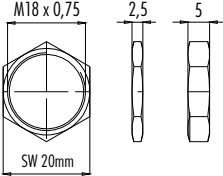

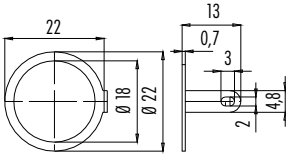
08 0045 000 001

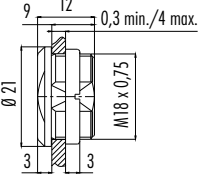

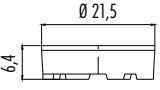
Ring nut for fixing thread

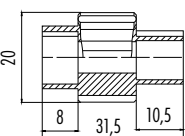
01 0010 001 with knurled screw



Description	Drawing	Thickness	Ordering-No.
<p>Hexagonal nut</p> 		<p>2,5 mm 5 mm</p>	<p>01 0146 001 01 5006 001</p>
<p>Solder eye ring</p> 		<p>Ordering-No. 04 0186 009</p>	
<p>Blind plug</p> 		<p>08 2668 000 001</p>	
<p>Distance sleeve for panel mount connectors, dip-solder version</p> 	 <p>PCB thickness: max. 1,5 mm</p>	<p>02 0007 000</p>	
<p>Mounting spanner for straight, shieldable cable connectors</p> 		<p>02 1785 000</p>	
<p>Crimping tool for single contacts</p> 	<p>Crimping tool for strip contacts</p> 	<p>66 0001 014 100 67 0001 014 100</p>	
<p>Extraction tool for crimp contacts</p> 		<p>07 0090 000</p>	



- Screw termination M23
- 6 – 19 contacts
- Degree of protection IP67
- Solder termination
- Diameter 26 mm
- Shieldable versions
- Clockwise thread

Description	Drawing	Contacts	Cable outlet	Ordering-No.
Male cable connector		6	6–10 mm	99 4635 00 06
		9		99 4601 00 09
		12		99 4605 00 12
		16		99 4609 00 16
		19		99 4631 00 19



Male cable connector, shieldable		6	6–10 mm	99 4645 00 06
		9		99 4619 00 09
		12		99 4621 00 12
		16		99 4623 00 16
		19		99 4643 00 19



Earth sleeves with seals have to be ordered separately. See page 70.

Male angled connector		6	6–10 mm	99 4635 70 06
		9		99 4601 70 09
		12		99 4605 70 12
		16		99 4609 70 16
		19		99 4631 70 19



### Specifications

Contacts	6	9	12	16	19
Wire gauge	2,5 mm <sup>2</sup> (AWG 14)	8x1,5 mm <sup>2</sup> (AWG 16)/ 1x2,5 mm <sup>2</sup> (AWG 14)	1,0 mm <sup>2</sup> (AWG 18)		16x1 mm <sup>2</sup> (AWG 18)/ 3x1,5 mm <sup>2</sup> (AWG 16)
Mechanical operation	> 50 Mating cycles				
Temperature range	– 20 °C /+ 125 °C				
Rated voltage	300 V			150 V	
Pollution degree	3				
Rated current (40°C)	20 A	8 x 8 A/1 x 20 A	8 A		16 x 8 A/3 x 10 A
Contact plating	Au (Gold)				
Material of housing	CuZn (brass nickel plated)				

**Description**

**Drawing**

**Contacts**

**Cable outlet**

**Ordering-No.**

Male coupling connector

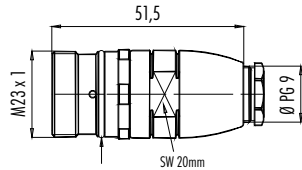

Immunity to vibration

6		99 4641 00 06
9		99 4613 00 09
12	6-10 mm	99 4615 00 12
16		99 4617 00 16
19		99 4639 00 19

Male coupling connector, shieldable

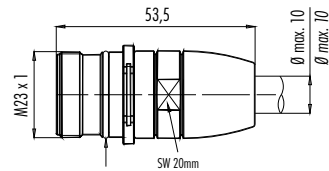

Immunity to vibration

6		99 4649 00 06
9		99 4625 00 09
12	6-10 mm	99 4627 00 12
16		99 4629 00 16
19		99 4647 00 19

Earth sleeves with seals have to be ordered separately. See page 70.

Male panel mount connector, central locking, PG 13,5

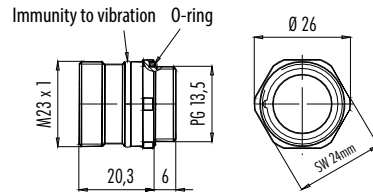

Immunity to vibration O-ring

6		99 4637 20 06
9		99 4603 20 09
12	-	99 4607 20 12
16		99 4611 20 16
19		99 4633 20 19

Male panel mount connector, front fastened

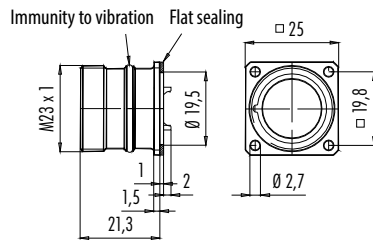

Immunity to vibration Flat sealing

6		99 4637 00 06
9		99 4603 00 09
12	-	99 4607 00 12
16		99 4611 00 16
19		99 4633 00 19

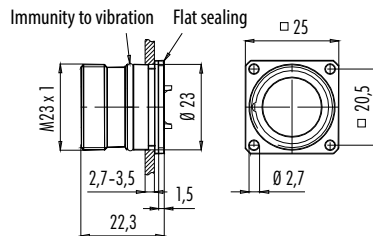

Male panel mount connector, fastened from back side

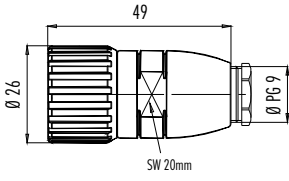

Immunity to vibration Flat sealing

6		99 4637 80 06
9		99 4603 80 09
12	-	99 4607 80 12
16		99 4611 80 16
19		99 4633 80 19

Description	Drawing	Contacts	Cable outlet	Ordering-No.	
Female cable connector			6–10 mm	6	99 4636 00 06
				9	99 4602 00 09
				12	99 4606 00 12
				16	99 4610 00 16
				19	99 4632 00 19

Female cable connector, shieldable			6–10 mm	6	99 4646 00 06
				9	99 4620 00 09
				12	99 4622 00 12
				16	99 4624 00 16
				19	99 4644 00 19

Earth sleeves with seals have to be ordered separately. See page 70.

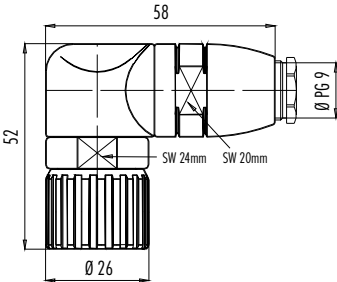
Female angled connector			6–10 mm	6	99 4636 70 06
				9	99 4602 70 09
				12	99 4606 70 12
				16	99 4610 70 16
				19	99 4632 70 19

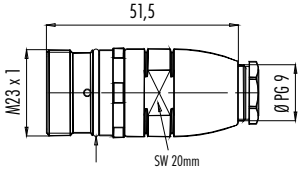
Female coupling connector			6–10 mm	6	99 4642 00 06
				9	99 4614 00 09
				12	99 4616 00 12
				16	99 4618 00 16
				19	99 4640 00 19

Immunity to vibration

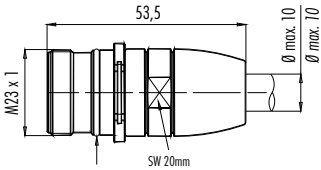
Female coupling connector, shieldable			6–10 mm	6	99 4650 00 06
				9	99 4626 00 09
				12	99 4628 00 12
				16	99 4630 00 16
				19	99 4648 00 19

Immunity to vibration

Earth sleeves with seals have to be ordered separately. See page 70.

**Description**

**Drawing**

**Contacts**

**Cable outlet**

**Ordering-No.**

Female panel mount connector, central locking, PG 13,5

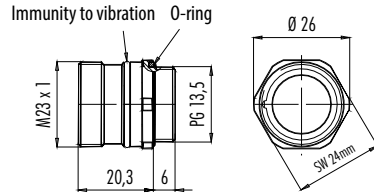

6		99 4638 20 06
9		99 4604 20 09
12	6-10 mm	99 4608 20 12
16		99 4612 20 16
19		99 4634 20 19

Female panel mount connector, front fastened

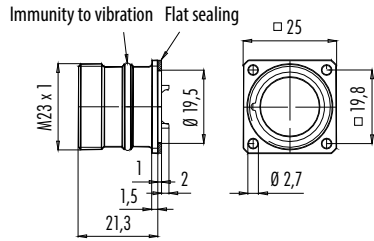

6		99 4638 00 06
9		99 4604 00 09
12	-	99 4608 00 12
16		99 4612 00 16
19		99 4634 00 19

Female panel mount connector, fastened from back side

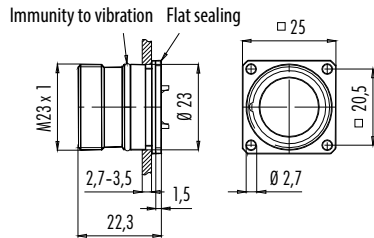

6		99 4638 80 06
9		99 4604 80 09
12	-	99 4608 80 12
16		99 4612 80 16
19		99 4634 80 19

**Contact arrangements male insert (mating side)**

6 contacts

9 contacts

12 contacts

16 contacts

19 contacts

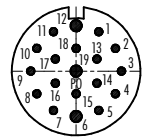
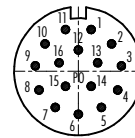
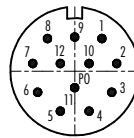
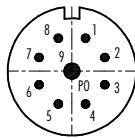
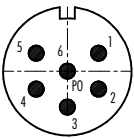

**Contact arrangements female insert (mating side)**

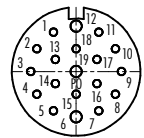
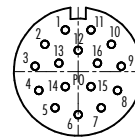
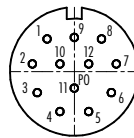
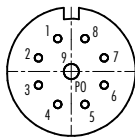
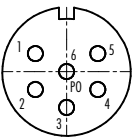

**Description**

**Drawing**

**Ordering-No.**

Protection cap for cable connectors, IP67

08 1201 001 001

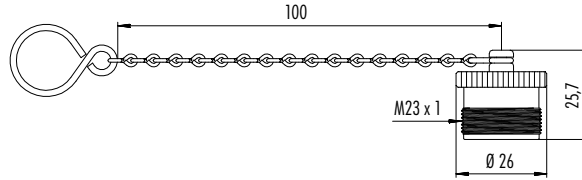

Protection cap for coupling connectors, IP67

08 1202 000 000

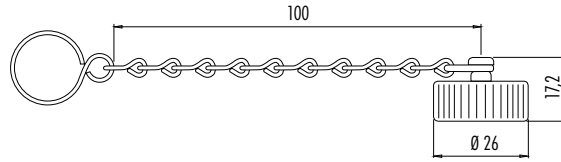

Protection cap for panel mount connectors with inner thread, IP67

08 1201 000 000

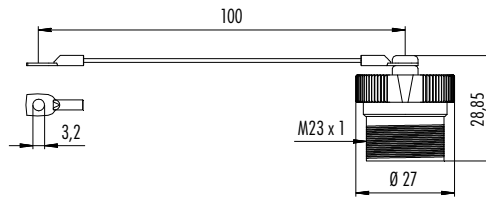

Protection cap for panel mount connectors with outer thread, IP67

08 1202 001 001

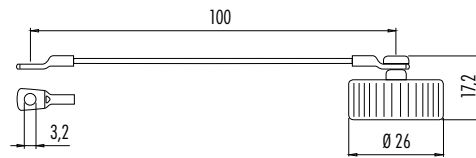

Protection cap for cable connectors, IP40

08 1203 000 000

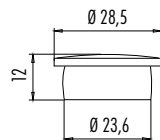

Protection cap for coupling and panel mount connectors, IP40

08 1204 000 000

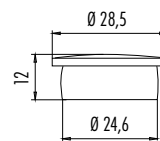

Mounting spanner

08 1205 000 000

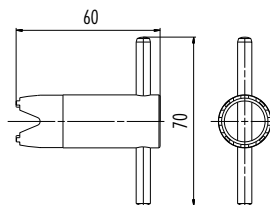

Earth sleeve with seal

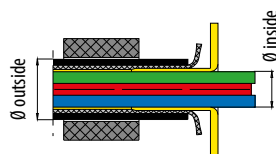

**Cable- $\varnothing$  in mm**

**Cable- $\varnothing$  in mm**

inside	outside	Ordering-No.	inside	outside	Ordering-No.
2,5	4,0	08 1200 040 025	4,6	8,5	08 1200 085 046
2,5	5,0	08 1200 050 025	5,2	7,5	08 1200 075 052
3,2	5,0	08 1200 050 032	5,2	8,5	08 1200 085 052
3,2	6,0	08 1200 060 032	5,2	10,0	08 1200 100 052
3,6	6,0	08 1200 060 036	5,5	7,5	08 1200 075 055
3,6	7,5	08 1200 075 036	5,5	8,5	08 1200 085 055
3,8	6,0	08 1200 060 038	5,5	10,0	08 1200 100 055
3,8	7,5	08 1200 075 038	6,2	10,0	08 1200 100 062
4,1	6,0	08 1200 060 041	6,6	10,0	08 1200 100 066
4,1	7,5	08 1200 075 041	7,0	10,0	08 1200 100 070
4,6	7,5	08 1200 075 046	7,4	10,0	08 1200 100 074







- Screw termination RD24
- 4- (3+PE) – 7- (6+PE) contacts
- Degree of protection IP67
- Solder-/Crimp-/Screw clamp termination
- Moulded versions
- Diameter 29 mm
- VDE-, SEV- and UL approval

### Description

Male cable connector, PG 9

### Drawing

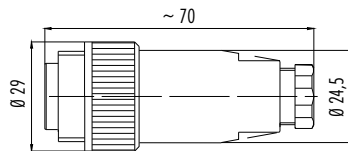

Crimp contacts see page 78

Male cable connector, PG 11

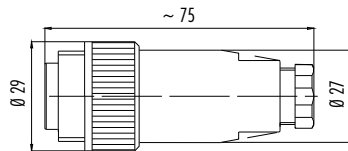

Crimp contacts see page 78

Male cable connector, PG 13,5

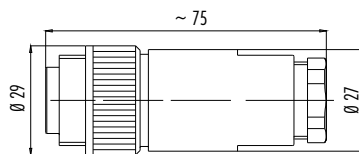

Crimp contacts see page 78

Male cable connector, PG 16



Crimp contacts see page 78

### Specifications

Contacts	3+PE (screw)	6+PE (solder)	6+PE (screw)	6+PE (crimp)
Wire gauge	0,5 mm <sup>2</sup> –2,5 mm <sup>2</sup> (AWG 20–AWG 14)	max.0,75 mm <sup>2</sup> (max. AWG 20)	0,34 mm <sup>2</sup> –1,5 mm <sup>2</sup> (AWG 22–AWG 16)	0,14 mm <sup>2</sup> –1,5 mm <sup>2</sup> (AWG 26–AWG 16)
Mechanical operation	> 500 Mating cycles			
Temperature range	– 40 °C /+ 100 °C			
Rated voltage	400 V (600 V UL)		250 V	
Pollution degree	3			
Rated current (40°C)	16 A (12 A UL)		10 A (8 A UL)	
Contact plating	Ag (Silver)			
Material of housing	PBT			

**Description**

Male cable connector, cable outlet 7–17 mm



**Drawing**

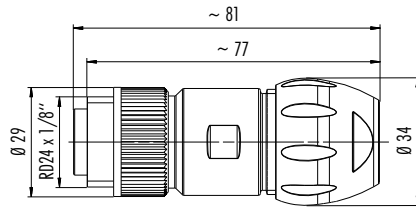

Crimp contacts see page 78

**Contacts**

**Termination**

**Cable outlet**

**Ordering-No.**

3+PE	screw clamp	7–17 mm	99 4221 300 04
	solder		99 4225 300 07
6+PE	screw clamp	7–17 mm	99 4217 300 07
	crimp		99 4201 300 07

**NEW**

Male angled connector, PG 9

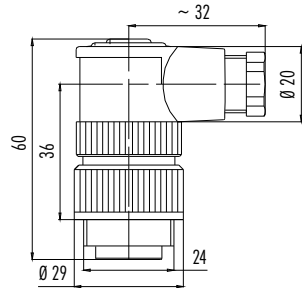

Crimp contacts see page 78

3+PE	screw clamp	6–8 mm	99 4221 70 04
	solder		99 4225 70 07
6+PE	screw clamp	6–8 mm	99 4217 70 07
	crimp		99 4201 70 07

Male angled connector, PG 11

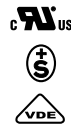
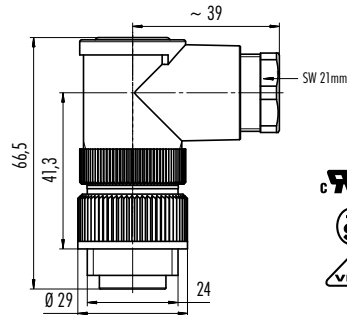

Crimp contacts see page 78

3+PE	screw clamp	12–14 mm	99 4221 210 04
	solder		99 4225 210 07
6+PE	screw clamp	12–14 mm	99 4217 210 07
	crimp		99 4201 210 07

Male angled connector, PG 13,5



Crimp contacts see page 78

3+PE	screw clamp	12–14 mm	99 4221 215 04
	solder		99 4225 215 07
6+PE	screw clamp	12–14 mm	99 4217 215 07
	crimp		99 4201 215 07

Male cable connector, moulded

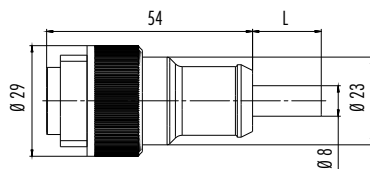

**Contacts**

**Cable length, PVC**

**Cable outlet**

**Ordering-No.**

3+PE x 1,5	2 m	–	79 0231 20 04
6+PE x 0,75			79 0235 20 07

Male angled connector, moulded

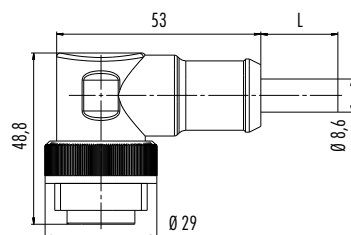

3+PE x 1,5	2 m	–	79 0233 20 04
6+PE x 0,75			79 0237 20 07

### Description

### Drawing

### Contacts

### Termination

### Cable outlet

### Ordering-No.

Female cable connector, PG 9

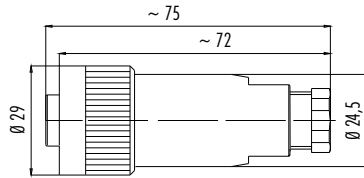

3+PE	screw clamp	6–9,5 mm	99 4222 00 04
	solder		99 4226 00 07
6+PE	screw clamp	6–8 mm	99 4218 00 07
	crimp		99 4202 00 07



Crimp contacts see page 78

Female cable connector, PG 11

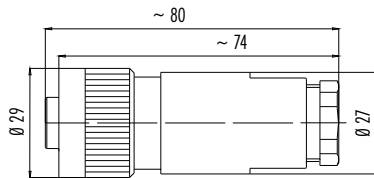

3+PE	screw clamp	8–10 mm	99 4222 110 04
	solder		99 4226 110 07
6+PE	screw clamp		99 4218 110 07
	crimp		99 4202 110 07



Crimp contacts see page 78

Female cable connector, PG 13,5



3+PE	screw clamp	10–12 mm	99 4222 14 04
	solder		99 4226 14 07
6+PE	screw clamp		99 4218 14 07
	crimp		99 4202 14 07



Crimp contacts see page 78

Female cable connector, PG 16



3+PE	screw clamp	12–14 mm	99 4222 160 04
	solder		99 4226 160 07
6+PE	screw clamp		99 4218 160 07
	crimp		99 4202 160 07



Crimp contacts see page 78

### Component part drawing

Cable connectors with cable strain relief PG 9 version, UL, VDE, SEV (screw 3+PE, solder)

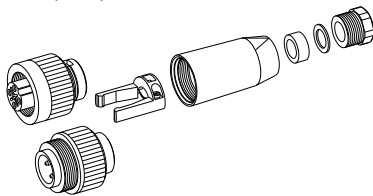

Female insert with ring nut/  
Male insert with ring nut  
Cable strain relief  
Shell  
Seal  
Thrust collar  
Pressing screw

Angled connectors

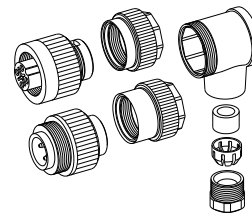

Female insert/  
Male insert  
Female angled sleeve/  
Male angled sleeve  
Angled hood  
Seal  
Pinch ring  
Pressing screw

Cable connectors with pinch ring PG 11, PG 13,5, PG 16 version

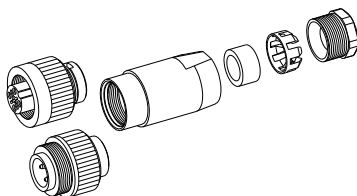

Female insert with ring nut/  
Male insert with ring nut  
Shell  
Seal  
Pinch ring  
Pressing screw

Cable connectors, vario cable outlet

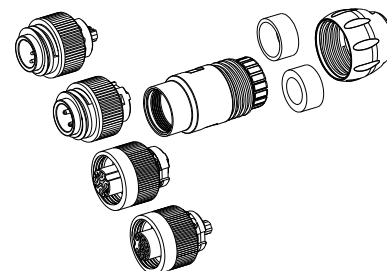

Male insert 3+PE/6+PE  
Female insert 3+PE/6+PE  
Sleeve  
Seal 7-13 mm/12-17 mm  
Pressing screw

**Description**

Female cable connector, cable outlet 7–17 mm



**Drawing**

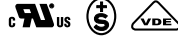
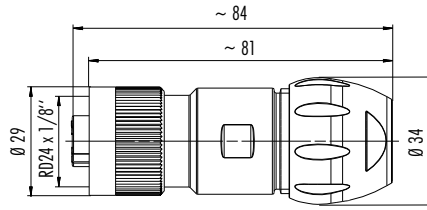

**Contacts**

**Termination**

**Cable outlet**

**Ordering-No.**

3+PE	screw clamp	7–17 mm	99 4222 300 04
	solder		99 4226 300 07
6+PE	screw clamp	7–17 mm	99 4218 300 07
	crimp		99 4202 300 07

**NEW**

Crimp contacts see page 78

Female angled connector, PG 9

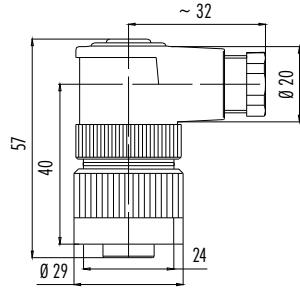

3+PE	screw clamp	6–8 mm	99 4222 70 04
	solder		99 4226 70 07
6+PE	screw clamp	6–8 mm	99 4218 70 07
	crimp		99 4202 70 07

Crimp contacts see page 78

Female angled connector, PG 11

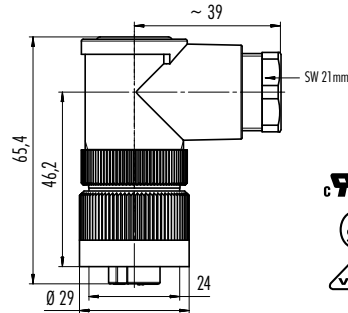

3+PE	screw clamp	12–14 mm	99 4222 210 04
	solder		99 4226 210 07
6+PE	screw clamp	12–14 mm	99 4218 210 07
	crimp		99 4202 210 07

Crimp contacts see page 78

Female angled connector, PG 13,5

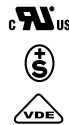

3+PE	screw clamp	12–14 mm	99 4222 215 04
	solder		99 4226 215 07
6+PE	screw clamp	12–14 mm	99 4218 215 07
	crimp		99 4202 215 07

Crimp contacts see page 78

Female cable connector, moulded

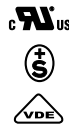
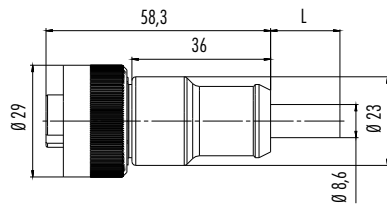





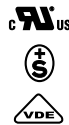
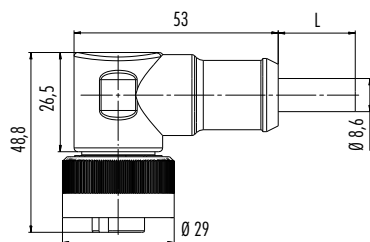





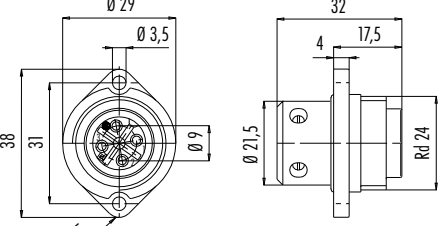
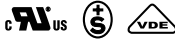

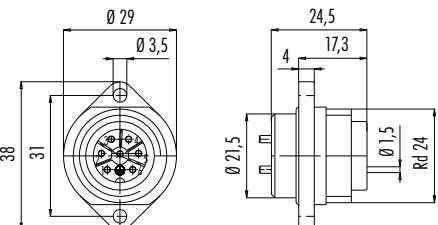



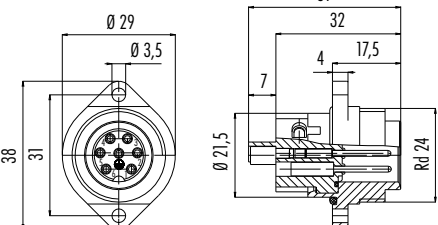



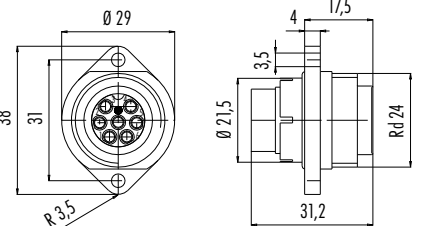



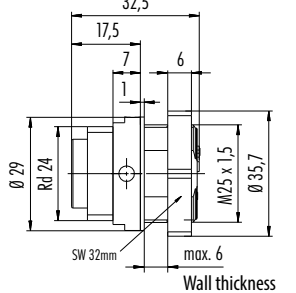



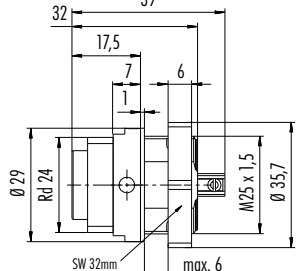





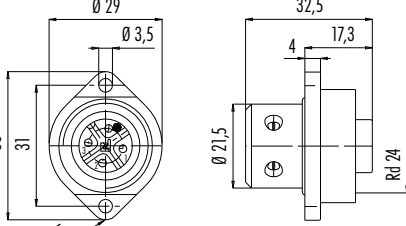



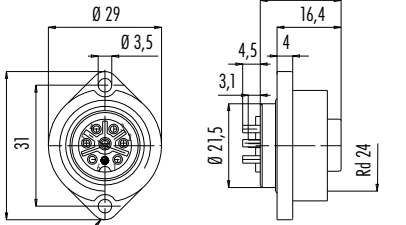



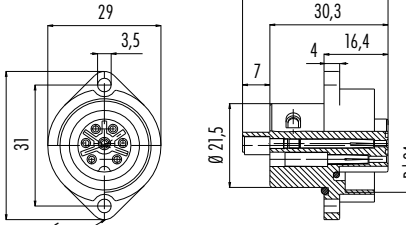

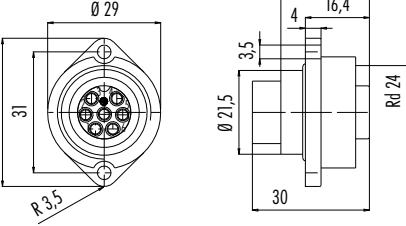

Contacts	Cable length, PVC	Cable outlet	Ordering-No.
3+PE x 1,5	2 m	–	79 0232 20 04
6+PE x 0,75			79 0236 20 07

Female angled connector, moulded

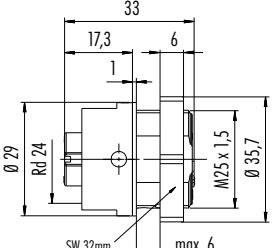

3+PE x 1,5	2 m	–	79 0234 20 04
6+PE x 0,75			79 0238 20 07

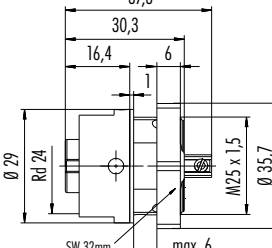
Description	Drawing	Contacts	Termination	Ordering-No.
<p>Male panel mount connector 3+PE, screw clamp termination</p>  	 	3+PE	screw clamp	09 4223 00 04
<p>Male panel mount connector 6+PE, solder termination</p>  	 	6+PE	solder	09 4227 00 07
<p>Male panel mount connector 6+PE, screw clamp termination</p>  	 	6+PE	screw clamp	09 4219 00 07
<p>Male panel mount connector 6+PE, crimp termination</p>  	 	6+PE	crimp	09 4203 00 07
<p>Male panel mount connector 3+PE, central locking, screw clamp termination</p>  	 	3+PE	screw	09 4223 150 04
<p>Male panel mount connector 6+PE, central locking, screw clamp termination</p>  	 	6+PE	screw	09 4219 150 07

Description	Drawing	Contacts	Termination	Ordering-No.
<p>Female panel mount connector 3+PE, screw clamp termination</p>  	 	3+PE	screw clamp	09 4224 00 04
<p>Female panel mount connector 6+PE, solder termination</p>  	 	6+PE	solder	09 4228 00 07
<p>Female panel mount connector 6+PE, screw clamp termination</p>  	 	6+PE	screw clamp	09 4220 00 07
<p>Female panel mount connector 6+PE, crimp termination</p>  	 	6+PE	crimp	09 4204 00 07
<p>Female panel mount connector 3+PE, central locking, screw clamp termination</p>  	 	3+PE	screw	09 4224 150 04
<p>Female panel mount connector 6+PE, central locking, screw clamp termination</p>  	 	6+PE	screw	09 4220 150 07

## Contact arrangements male insert (mating side)

3+PE contacts

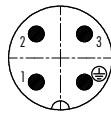

6+PE contacts

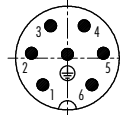

## Contact arrangements female insert (mating side)

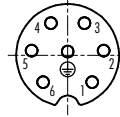
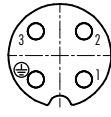

## Panel cut out

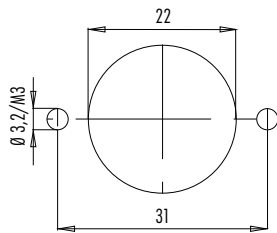

## Central locking

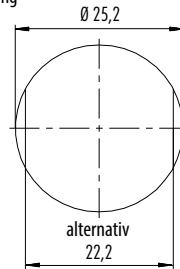

## Colour of wire, moulded cable connectors

1	black 1	1	black 1
2	black 2	2	black 2
3	black 3	3	black 3
⊕	green/yellow	4	black 4
		5	black 5
		6	black 6
		⊕	green/yellow

## Description

## Drawing

## A B Wire gauge AWG Ordering-No.

Single contact (Male), Signal, PU 100 pieces

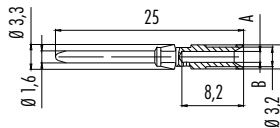

0,9	2,6	0,14–0,34 mm <sup>2</sup>	26–22	61 0891 139
1,1	2,6	0,5 mm <sup>2</sup>	20	61 0892 139
1,45	2,6	0,75–1,0 mm <sup>2</sup>	18	61 0893 139
1,8	3,0	1,5 mm <sup>2</sup>	16	61 0894 139

Single contact (Female), Signal, PU 100 pieces

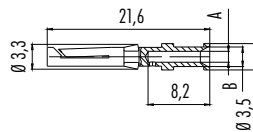

0,9	2,6	0,14–0,34 mm <sup>2</sup>	26–22	61 0896 139
1,1	2,6	0,5 mm <sup>2</sup>	20	61 0897 139
1,45	2,6	0,75–1,0 mm <sup>2</sup>	18	61 0898 139
1,8	3,0	1,5 mm <sup>2</sup>	16	61 0899 139

Protection cap for male cable connector, IP67

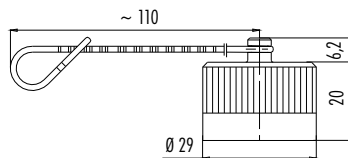

## Ordering-No.

08 2299 000 000

Protection cap for female cable connector, IP67

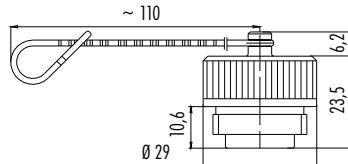

08 2300 000 000

Protection cap for male panel mount connector, IP67

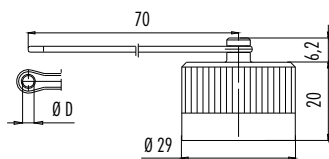

## Hole-Ø D

## Ordering-No.

3 mm	08 2301 000 000
21,5 mm	08 2672 000 000

Protection cap for female panel mount connector, IP67

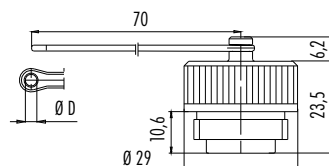

3 mm	08 2302 000 000
21,5 mm	08 2673 000 000



**Description**

**Drawing**

**Ordering-No.**

Strain relief

08 0628 000 008

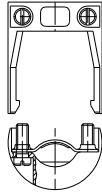

Flat seal for panel mount connectors

04 0722 000

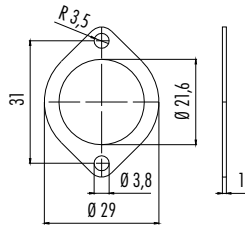

Bulkhead housing

16 0566 00 00

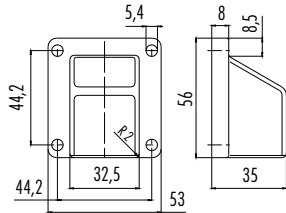

Protection cap for panel mount connectors with screw termination, termination side

16 0565 00 00

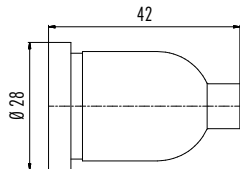

Crimping tool for turned crimp contacts

66 0003 001



Extraction tool for turned crimp contacts

66 0004 001 signal contact





- Bayonet locking system
- 8 and 12 contacts
- Degree of protection IP68/IP69K
- Crimp termination
- Diameter 36 mm
- VDE-, UL-approval
- Designed for harsh environments

### Description

Male cable connector



### Drawing

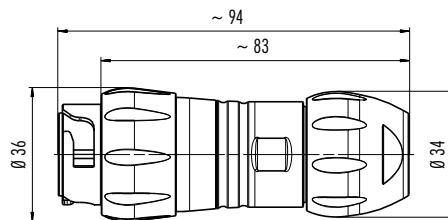

### Contacts

4+PE	7-17 mm
4 + 3+PE	7-13 mm
12	7-13 mm

### Cable outlet

### Ordering-No.

99 6489 000 05	UL  in prep.
99 6501 000 08	
99 6517 000 12	

**NEW**

Crimp contacts see page 82



Female cable connector

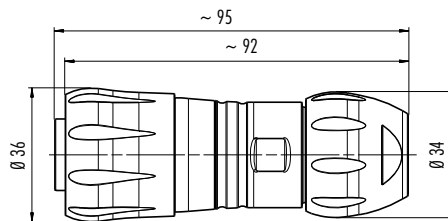

4+PE	7-17 mm
4 + 3+PE	7-13 mm
12	7-13 mm

99 6490 000 05	
99 6502 000 08	
99 6518 000 12	

**NEW**

Crimp contacts see page 82



Male panel mount connector

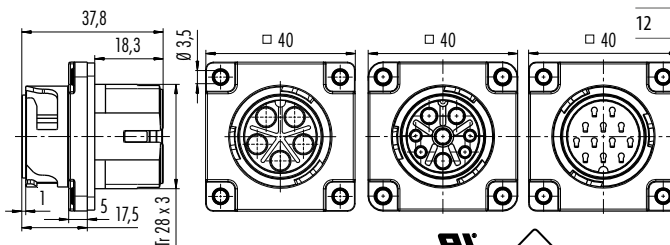

4+PE	-
4 + 3+PE	-
12	-

99 6491 000 05	
09 6503 000 08	
09 6519 000 12	

**NEW**

Crimp contacts see page 82

Female panel mount connector

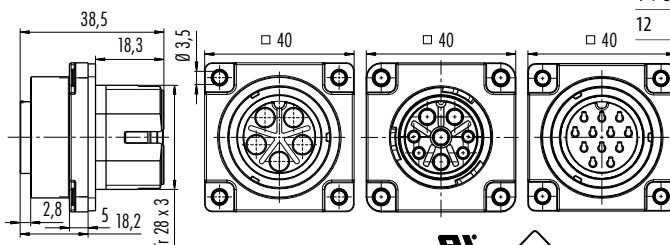

4+PE	-
4 + 3+PE	-
12	-

99 6492 000 05	
09 6504 000 08	
09 6520 000 12	

**NEW**

Crimp contacts see page 82



### Specifications

Contacts	4+PE	8 (4 + 3+PE)	12
Wire gauge	2,5 mm <sup>2</sup> -6,0 mm <sup>2</sup> (AWG 14-AWG 10)	0,14 mm <sup>2</sup> -2,5 mm <sup>2</sup> (AWG 26-AWG 14)	Male/female cable connector 0,14-0,75 mm <sup>2</sup> ; Male/female panel mount connector 0,14-1,0 mm <sup>2</sup> (AWG 26-18)
Mechanical operation	> 1000 Mating cycles		> 500 Mating cycles
Temperature range	- 40 °C /+ 100 °C		
Rated voltage	600 V	60 V Signal, 400 V Power	250 V
Pollution degree	3		
Rated current (40°C)	32 A <sup>1)</sup>	3 A Signal, 25 A Power (USR 20 A, CNR 16 A)	5 A
Contact plating	Ag (Crimp contacts see page 79)		
Material of housing	PA		

## Description

Female panel mount connector, hinged cover



## Drawing

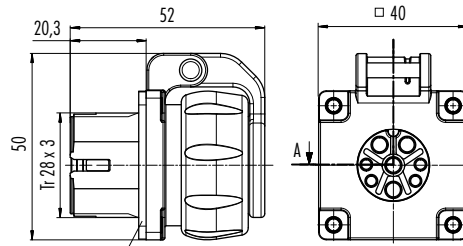

## Contacts

Contacts	Ordering-No.
4+PE	99 6492 200 05
4 + 3+PE	99 6504 200 08
12	99 6520 200 12

**NEW**

## Component part drawing

Cable connectors

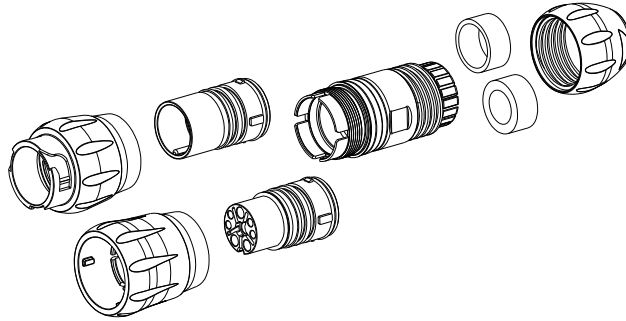

Male locking device/  
Female locking device  
Female insert/  
Male insert  
Sleeve  
Seals 12–17 mm/7–13 mm  
Pressing screw

Panel mount connectors

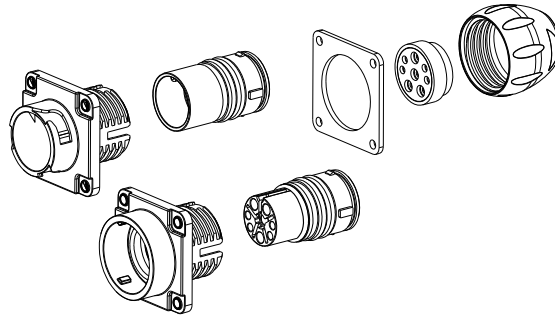

Male housing/  
Female housing  
Female insert with O-rings/  
Male insert with O-rings  
Flat seal  
Optional with set of sealings

## Contact arrangements male insert (mating side)

5 contacts

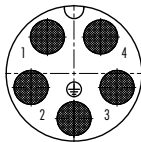

8 contacts

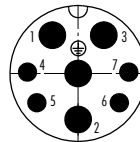

12 contacts

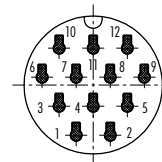

## Contact arrangements female insert (mating side)

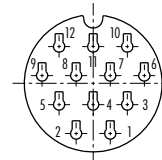
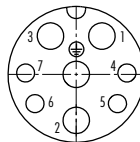
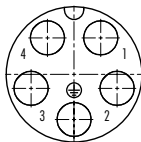

## Panel cut out

Panel mount connectors

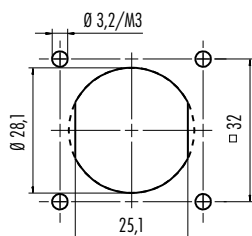

alternative with flattening

## Description

Male contact, power, PU 100 pieces, for 4+PE version

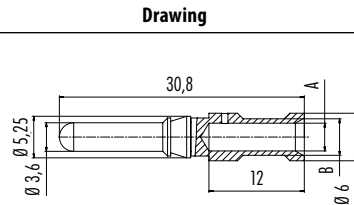

Contact-Ø	A	B	Wire gauge	AWG	Ordering-No.
1,6 mm	2,2	3,3	2,5 mm <sup>2</sup>	14	61 1312 139
	2,8	3,9	4,0 mm <sup>2</sup>	12	61 1310 139
	3,5	4,6	6,0 mm <sup>2</sup>	10	61 1285 139

**NEW**

Female contact, power, PU 100 pieces, for 4+PE version

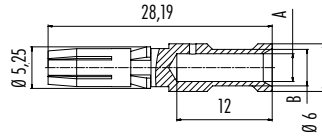

3,6 mm	2,2	3,3	2,5 mm <sup>2</sup>	14	61 1313 139
	2,8	3,9	4,0 mm <sup>2</sup>	12	61 1311 139
	3,5	4,6	6,0 mm <sup>2</sup>	10	61 1286 139

**NEW**

Single contact (Male), Signal/Power, PU 100 pieces for 4 + 3+PE version

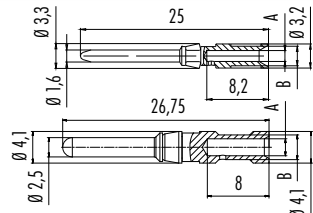

1,6 mm	0,9	2,6	0,14–0,34 mm <sup>2</sup>	26–22	61 0891 139
	1,1	2,6	0,5 mm <sup>2</sup>	20	61 0892 139
	1,45	2,6	0,75–1,0 mm <sup>2</sup>	18	61 0893 139
	1,8	3,0	1,5 mm <sup>2</sup>	16	61 0894 139
2,5 mm	1,8	3,0	1,5 mm <sup>2</sup>	16	61 0903 139
	2,2	3,2	2,5 mm <sup>2</sup>	14	61 0902 139

Single contact (Female), Signal/Power, PU 100 pieces for 4 + 3+PE version

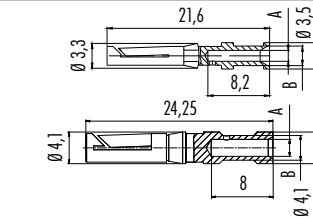

1,6 mm	0,9	2,6	0,14–0,34 mm <sup>2</sup>	26–22	61 0896 139
	1,1	2,6	0,5 mm <sup>2</sup>	20	61 0897 139
	1,45	2,6	0,75–1,0 mm <sup>2</sup>	18	61 0898 139
	1,8	3,0	1,5 mm <sup>2</sup>	16	61 0899 139
2,5 mm	1,8	3,0	1,5 mm <sup>2</sup>	16	61 0901 139
	2,2	3,2	2,5 mm <sup>2</sup>	14	61 0900 139

Single contact (Male), PU 50 pieces for 12 contacts version

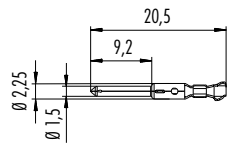

Single contact (Female), PU 50 pieces for 12 contacts version

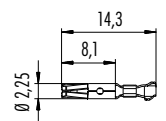

Strip contact (Male) for 12 contacts version

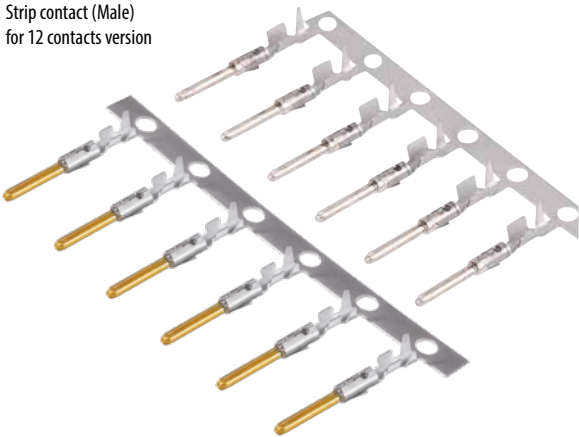

Contact-Ø	Insulating-Ø	Wire gauge	PU	Pieces	Silver	Gold	
1,0–2,0 mm	0,14–0,25 mm <sup>2</sup>	0,75–1,0 mm <sup>2</sup>	Single	50	61 0799 085 00	61 0799 098 00	
			Strip	200	65 0799 085 01	65 0799 098 01	
			Strip	2.000	65 0799 085 02	65 0799 098 02	
			Strip	4.000	65 0799 085 04	65 0799 098 04	
			Strip	10.000	65 0799 085 10	65 0799 098 10	
			Strip	10.000	65 0799 085 10	65 0799 098 10	
	1,5 mm	0,35–0,5 mm <sup>2</sup>	0,75–1,0 mm <sup>2</sup>	Single	50	61 0795 085 00	61 0795 098 00
				Strip	200	65 0795 085 01	65 0795 098 01
				Strip	2.000	65 0795 085 02	65 0795 098 02
				Strip	4.000	65 0795 085 04	65 0795 098 04
				Strip	10.000	65 0795 085 10	65 0795 098 10
				Strip	10.000	65 0795 085 10	65 0795 098 10
1,6–2,1 mm	0,14–0,25 mm <sup>2</sup>	0,75–1,0 mm <sup>2</sup>	Single	50	61 0796 085 00	61 0796 098 00	
			Strip	200	65 0796 085 01	65 0796 098 01	
			Strip	2.000	65 0796 085 02	65 0796 098 02	
			Strip	4.000	65 0796 085 04	65 0796 098 04	
			Strip	10.000	65 0796 085 10	65 0796 098 10	
			Strip	10.000	65 0796 085 10	65 0796 098 10	
	1,5 mm	0,35–0,5 mm <sup>2</sup>	0,75–1,0 mm <sup>2</sup>	Single	50	61 0797 085 00	61 0797 098 00
				Strip	200	65 0797 085 01	65 0797 098 01
				Strip	2.000	65 0797 085 02	65 0797 098 02
				Strip	4.000	65 0797 085 04	65 0797 098 04
				Strip	10.000	65 0797 085 10	65 0797 098 10
				Strip	10.000	65 0797 085 10	65 0797 098 10

Strip contact (Female) for 12 contacts version

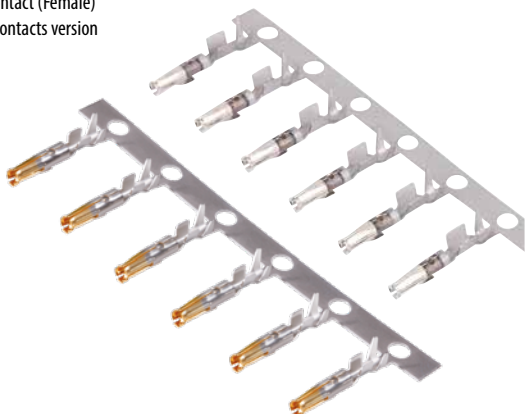

1,0–2,0 mm	0,14–0,25 mm <sup>2</sup>	0,75–1,0 mm <sup>2</sup>	Single	50	61 0800 085 00	61 0800 098 00	
			Strip	200	65 0800 085 01	65 0800 098 01	
			Strip	2.000	65 0800 085 02	65 0800 098 02	
			Strip	4.000	65 0800 085 04	65 0800 098 04	
			Strip	10.000	65 0800 085 10	65 0800 098 10	
			Strip	10.000	65 0800 085 10	65 0800 098 10	
	1,5 mm	0,35–0,5 mm <sup>2</sup>	0,75–1,0 mm <sup>2</sup>	Single	50	61 0798 085 00	61 0798 098 00
				Strip	200	65 0798 085 01	65 0798 098 01
				Strip	2.000	65 0798 085 02	65 0798 098 02
				Strip	4.000	65 0798 085 04	65 0798 098 04
				Strip	10.000	65 0798 085 10	65 0798 098 10
				Strip	10.000	65 0798 085 10	65 0798 098 10

**Description**

Protection cap for male cable connectors, IP67

**Drawing**

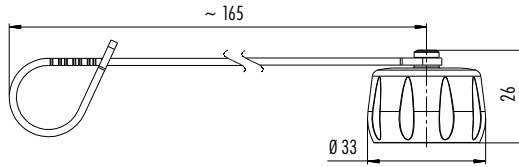

**Ordering-No.**

08 3107 000 000

Protection cap for female cable connectors, IP67

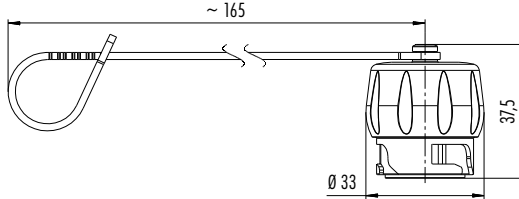

08 3108 000 000

Protection cap for male panel mount connectors, IP67

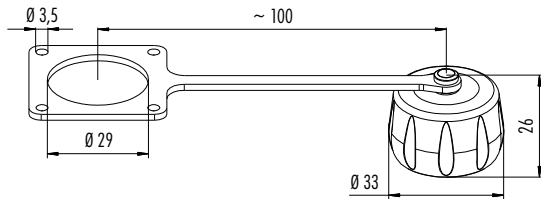

08 3109 000 000

Protection cap for female panel mount connectors, IP67

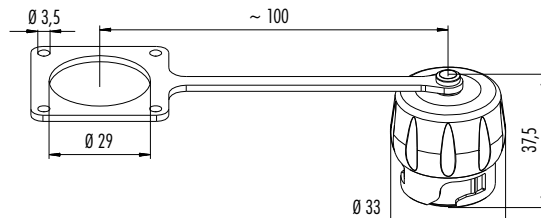

08 3110 000 000

Crimping tool for turned crimp contacts



Crimping tool for stamped single contacts



Crimping tool for strip contacts



66 0005 000	turned contacts	5 contacts	■
66 0003 001	turned contacts	8 contacts	
66 0001 014 100	stamped contacts	12 contacts	
67 0001 014 100	strip contacts		

■ **NEW**

Extraction tool for turned crimp contacts



Extraction tool for stamped single contacts



66 0012 001	turned contacts	5 contacts	■
66 0004 001	turned contacts signal contact	8 contacts	
66 0011 001	turned contacts power contact	8 contacts	
07 0090 000	stamped contacts	12 contacts	

■ **NEW**

Sealing kit, IP67

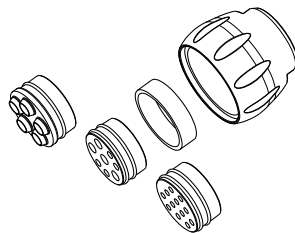

Seal for single wires  
Thrust ring  
Pressing screw

**Contacts Ordering-No.**

4+PE	08 3274 000 000	without thrust ring	■
4 + 3+PE	08 3111 000 000	with thrust ring	
12	08 3232 000 000	with thrust ring	

■ **NEW**

Cable



**Wire gauge**

4 x 1,0 mm<sup>2</sup>, 4 x 2,5 mm<sup>2</sup>

**Cable length**

100 m

**Ordering-No.**

08 3186 000 000



- Screw termination RD30
- 5- (4+PE), 13- (12+PE) and 24 contacts
- Degree of protection IP65
- Solder-/Screw clamp termination
- Diameter 40 mm
- Variants with VDE-, SEV-approval

### Description

Male cable connector

### Drawing

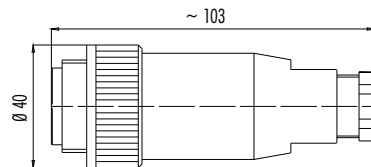

### Contacts

### Cable outlet

### Ordering-No.

4+PE	10–12 mm	99 0709 00 05		
	12–14 mm	99 0709 02 05		
	14–18 mm	99 0709 03 05		
12+PE	10–12 mm	99 0717 00 13		
	12–14 mm	99 0717 02 13		
	14–18 mm	99 0717 03 13		
24	10–12 mm	99 0737 00 24		
	12–14 mm	99 0737 02 24		
	14–18 mm	99 0737 03 24		

Male angled connector

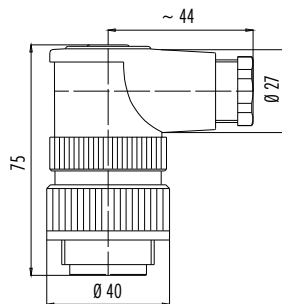

4+PE	10–12 mm	99 0709 70 05		
	12–14 mm	99 0709 72 05		
	14–18 mm	99 0709 73 05		
12+PE	10–12 mm	99 0717 70 13		
	12–14 mm	99 0717 72 13		
	14–18 mm	99 0717 73 13		
24	10–12 mm	99 0737 70 24		
	12–14 mm	99 0737 72 24		
	14–18 mm	99 0737 73 24		

Female cable connector

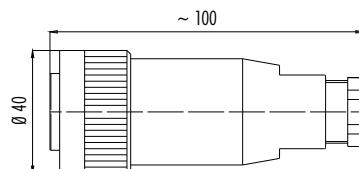

4+PE	10–12 mm	99 0710 00 05		
	12–14 mm	99 0710 02 05		
	14–18 mm	99 0710 03 05		
12+PE	10–12 mm	99 0718 00 13		
	12–14 mm	99 0718 02 13		
	14–18 mm	99 0718 03 13		
24	10–12 mm	99 0738 00 24		
	12–14 mm	99 0738 02 24		
	14–18 mm	99 0738 03 24		

Female angled connector

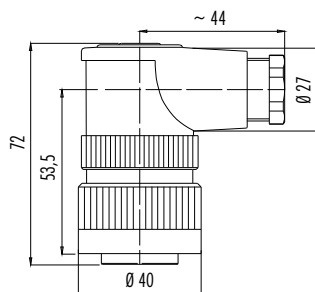

4+PE	10–12 mm	99 0710 70 05		
	12–14 mm	99 0710 72 05		
	14–18 mm	99 0710 73 05		
12+PE	10–12 mm	99 0718 70 13		
	12–14 mm	99 0718 72 13		
	14–18 mm	99 0718 73 13		
24	10–12 mm	99 0738 70 24		
	12–14 mm	99 0738 72 24		
	14–18 mm	99 0738 73 24		

### Specifications

Contacts	4+PE	12+PE	24
Wire gauge	max. 2,5 mm <sup>2</sup> (max. AWG 14)	max. 1,0 mm <sup>2</sup> (max. AWG 18)	max. 0,25 mm <sup>2</sup> (max. AWG 24)
Mechanical operation	> 500 Mating cycles		
Temperature range	– 40 °C /+ 100 °C		
Rated voltage	400 V	250 V	125 V
Pollution degree	3		
Rated current (40°C)	20 A	6 A	3 A
Contact plating	Ag (Silver)		Au (Gold)
Material of housing	PA		

**Description**

Male panel mount connector

**Drawing**

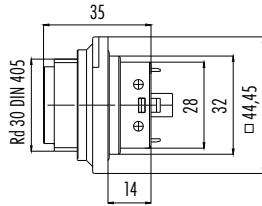

**Contacts**

**Ordering-No.**

4+PE	99 0711 00 05	
12+PE	99 0719 00 13	
24	99 0739 00 24	

Female panel mount connector

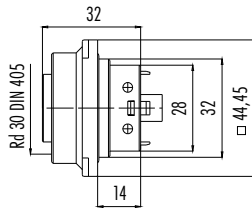

4+PE	99 0712 00 05	
12+PE	99 0720 00 13	
24	99 0740 00 24	

**Component part drawing**

Cable connectors

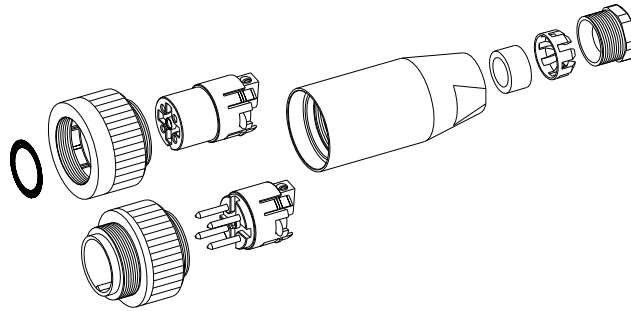

- O-ring 21 x 1,5
- Female housing/
- Male housing
- Female insert/
- Male insert
- Sleeve
- Seal
- Pinch ring
- Pressing screw

**Contact arrangements male insert (mating side)**

4+PE contacts

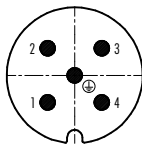

12+PE contacts

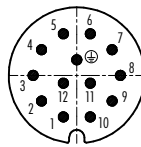

24 contacts

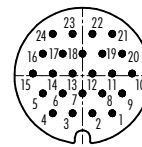

**Contact arrangements female insert (mating side)**

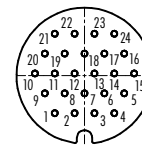
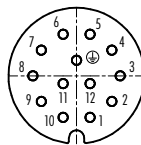
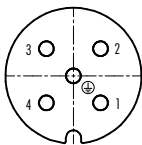

**Panel cut out**

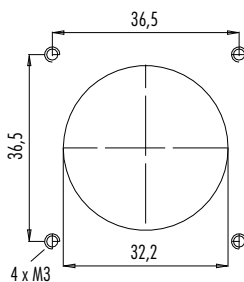

**Protection caps for**

Male cable connector	08 0425 000 000
Female cable connector	08 0426 000 000
Male panel mount connector	08 0427 000 000
Female panel mount connector	08 0428 000 000

See on [www.binder-connector.com](http://www.binder-connector.com)



- Locking system with snap hooks
- 12 contacts
- Degree of protection IP54
- Solder termination
- Ergonomic design of connector
- Colour in greywhite similar to RAL 9002

**Description**

Male cable connector

**Drawing**

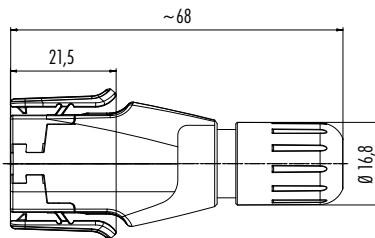

**Contacts**

**Cable outlet max.**

**Ordering-No.**

12	4–6 mm	99 1721 002 12
	6–8 mm	99 1721 000 12

Female panel mount connector, solder

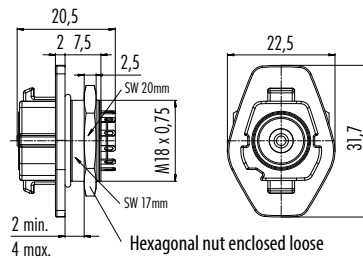

**Contacts**

**Ordering-No.**

12	99 1724 000 12
----	----------------

Female panel mount connector, solder

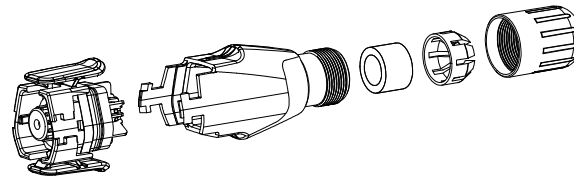

- Male contact body
- Male insert
- Sealing
- O-ring
- Male contact solder
- Sleeve
- Seal
- Pinch ring
- Pressing screw

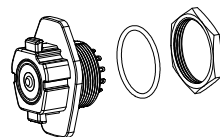

- Female contact body
- Female insert
- Contact spring solder
- O-ring
- Hexagonal nut

**Specifications**

Contacts	12
Wire gauge	max. 0,25 mm <sup>2</sup> (max. AWG 24)
Mechanical operation	> 5000 Mating cycles
Temperature range	-25 °C / + 85 °C
Rated voltage	175 V
Pollution degree	2
Rated current (40°C)	2 A
Contact plating	Au (Gold)
Material of housing	PA 66



## Contact arrangements male insert (termination side)

12 contacts

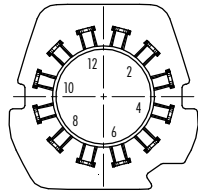

	X	Y
1	1,59	5,94
2	4,35	4,35
3	5,94	1,59
4	5,94	-1,59
5	4,35	-4,35
6	1,59	-5,94
7	-1,59	-5,94
8	-4,35	-4,35
9	-5,94	-1,59
10	-5,94	1,59
11	-4,35	4,35
12	-1,59	5,94

## Contact arrangements female insert (termination side)

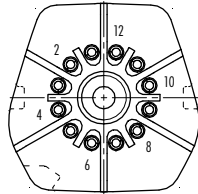

	X	Y
1	-1,09	4,06
2	-2,97	2,97
3	-4,06	1,09
4	-4,06	-1,09
5	-2,97	-2,97
6	-1,09	-4,06
7	1,09	-4,06
8	2,97	-2,97
9	4,06	-1,09
10	4,06	1,09
11	2,97	2,97
12	1,09	4,06

## Panel cut out

Panel mount connectors

Alternative with flats

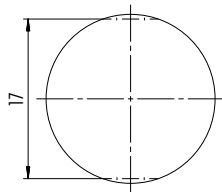

Mounting wall

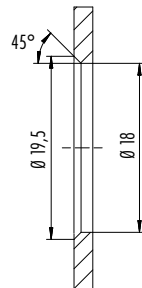



- Snap-in locking system
- 3 – 8 contacts
- Degree of protection IP67
- Solder termination
- Diameter 11,5 mm
- Moulded versions on request
- Colour in greywhite similar to RAL 9002

### Description

Male cable connector

### Drawing

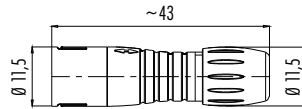

### Contacts Cable outlet Greywhite

Contacts	Cable outlet	Greywhite
3		99 9205 400 03
4	3–5 mm	99 9209 400 04
5		99 9213 400 05
8		99 9225 400 08

Male cable connector, red, blue, green



### Red Blue Green

Contacts	Cable outlet	Red	Blue	Green
3		99 9205 450 03	99 9205 460 03	99 9205 470 03
4	3–5 mm	99 9209 450 04	99 9209 460 04	99 9209 470 04
5		99 9213 450 05	99 9213 460 05	99 9213 470 05
8		99 9225 450 08	99 9225 460 08	99 9225 470 08

Female cable connector

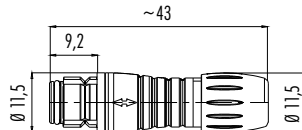

### Greywhite

Contacts	Cable outlet	Greywhite
3		99 9206 400 03
4	3–5 mm	99 9210 400 04
5		99 9214 400 05
8		99 9226 400 08

Female cable connector, red, blue, green



### Red Blue Green

Contacts	Cable outlet	Red	Blue	Green
3		99 9206 450 03	99 9206 460 03	99 9206 470 03
4	3–5 mm	99 9210 450 04	99 9210 460 04	99 9210 470 04
5		99 9214 450 05	99 9214 460 05	99 9214 470 05
8		99 9226 450 08	99 9226 460 08	99 9226 470 08

### Specifications

Contacts	3	4	5	8
Wire gauge	max. 0,25 mm <sup>2</sup> (max. AWG 24)			
Mechanical operation	> 500 Mating cycles			
Temperature range	–40 °C / + 85 °C			
Rated voltage	125 V		63 V	
Pollution degree	2			
Rated current (40°C)	3 A	2,5 A	2 A	1 A
Contact plating	Au (Gold)			
Material of housing	PA			

**Description**  
Male panel mount connector, solder termination/dip-solder termination

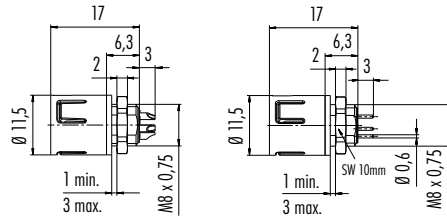

Contacts	Solder termination	Dip-solder termination
3	99 9207 400 03	99 9207 490 03
4	99 9211 400 04	99 9211 490 04
5	99 9215 400 05	99 9215 490 05
8	99 9227 400 08	99 9227 490 08

Male panel mount connector, solder termination

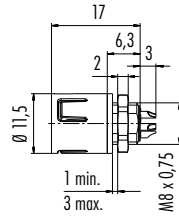

	Red	Blue	Green
3	99 9207 050 03	99 9207 060 03	99 9207 070 03
4	99 9211 050 04	99 9211 060 04	99 9211 070 04
5	99 9215 050 05	99 9215 060 05	99 9215 070 05
8	99 9227 050 08	99 9227 060 08	99 9227 070 08

Female panel mount connector, solder termination/dip-solder termination

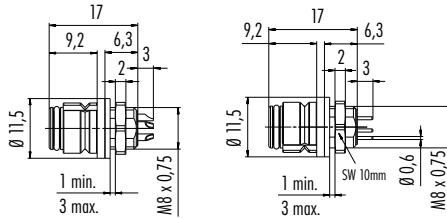

	Solder termination	Dip-solder termination
3	99 9208 400 03	99 9208 490 03
4	99 9212 400 04	99 9212 490 04
5	99 9216 400 05	99 9216 490 05
8	99 9228 400 08	99 9228 490 08

Female panel mount connector, solder termination

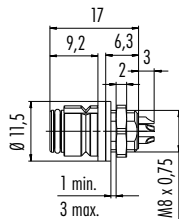

	Red	Blue	Green
3	99 9208 050 03	99 9208 060 03	99 9208 070 03
4	99 9212 050 04	99 9212 060 04	99 9212 070 04
5	99 9216 050 05	99 9216 060 05	99 9216 070 05
8	99 9228 050 08	99 9228 060 08	99 9228 070 08

Adapter for panel mount connector for recessed mounting

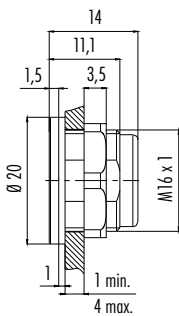

**Ordering-No.**

08 2636 400 001

**Component part drawing**

Cable connectors

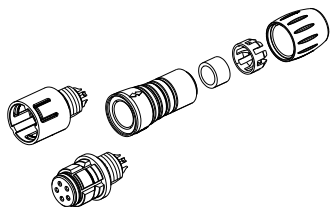

Male insert  
Female insert  
Sleeve  
Seal  
Pinch ring  
Pressing screw

Panel mount connectors solder/dip-solder

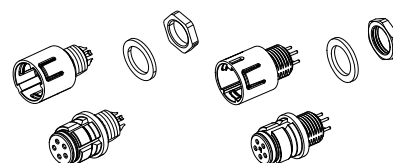

Male insert  
Female insert  
Flat seal  
Hexagonal nut

Adapter

Adapter  
Flat seal  
Hexagonal nut

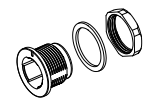



- Snap-in locking system
- 3 – 12 contacts
- Degree of protection IP67
- Solder termination
- Diameter 16 mm
- Coloured types
- Moulded versions on request
- Colour in greywhite similar to RAL 9002

### Description

Male cable connector



### Drawing

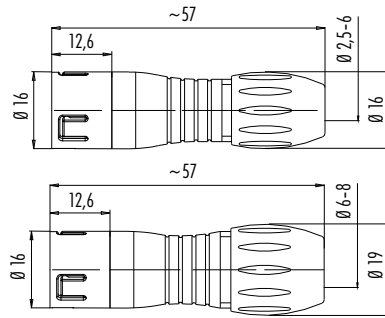

### Contacts Cable outlet Greywhite

Contacts	Cable outlet	Greywhite
3		99 9105 400 03
5	4–6 mm	99 9113 400 05
8		99 9125 400 08
12	6–8 mm	99 9133 402 12

Male cable connector, red, blue, green



Contacts	Cable outlet	Red	Blue	Green
3		99 9105 450 03	99 9105 460 03	99 9105 470 03
5	4–6 mm	99 9113 450 05	99 9113 460 05	99 9113 470 05
8		99 9125 450 08	99 9125 460 08	99 9125 470 08
12	6–8 mm	99 9133 452 12	99 9133 462 12	99 9133 472 12

Female cable connector

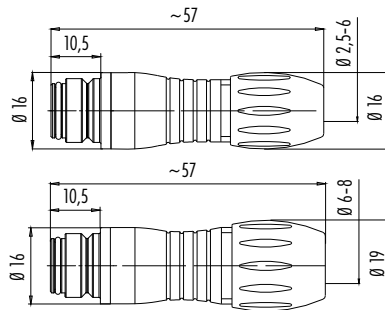

### Contacts Cable outlet Greywhite

Contacts	Cable outlet	Greywhite
3		99 9106 400 03
5	4–6 mm	99 9114 400 05
8		99 9126 400 08
12	6–8 mm	99 9134 402 12

Female cable connector, red, blue, green



Contacts	Cable outlet	Red	Blue	Green
3		99 9106 450 03	99 9106 460 03	99 9106 470 03
5	4–6 mm	99 9114 450 05	99 9114 460 05	99 9114 470 05
8		99 9126 450 08	99 9126 460 08	99 9126 470 08
12	6–8 mm	99 9134 452 12	99 9134 462 12	99 9134 472 12

### Specifications

Contacts	3	5	8	12
Wire gauge	max. 0,75 mm <sup>2</sup> (max. AWG 20)		max. 0,25 mm <sup>2</sup> (max. AWG 24)	
Mechanical operation	> 500 Mating cycles			
Temperature range	–25 °C / + 85 °C			
Rated voltage	250 V	125 V		60 V
Pollution degree	2			
Rated current (40°C)	7 A	5 A	2 A	
Contact plating	Au (Gold)			
Material of housing	PA			

### Description

### Drawing

### Contacts

### Solder termination

### Dip-solder termination

Male panel mount connector, solder termination/dip-solder termination

3	99 9107 400 03	99 9107 490 03
5	99 9115 400 05	99 9115 490 05
8	99 9127 400 08	99 9127 490 08
12	99 9135 400 12	99 9135 490 12

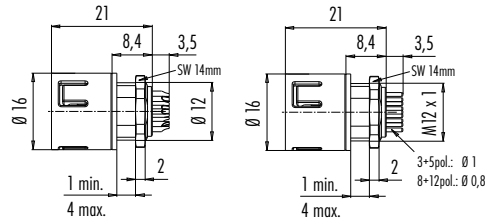

Male panel mount connector, solder termination

	Red	Blue	Green
3	99 9107 50 03	99 9107 60 03	99 9107 70 03
5	99 9115 50 05	99 9115 60 05	99 9115 70 05
8	99 9127 50 08	99 9127 60 08	99 9127 70 08
12	99 9135 50 12	99 9135 60 12	99 9135 70 12

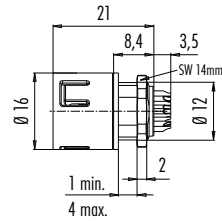

Female panel mount connector, solder termination/dip-solder termination

	Red	Blue	Green
3	99 9108 400 03	99 9108 490 03	
5	99 9116 400 05	99 9116 490 05	
8	99 9128 400 08	99 9128 490 08	
12	99 9136 400 12	99 9136 490 12	

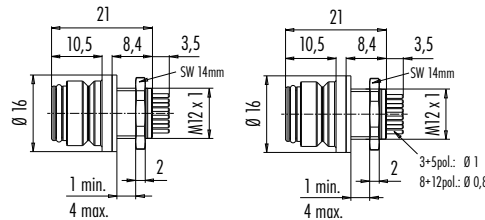

Female panel mount connector, solder termination

3	99 9108 50 03	99 9108 60 03	99 9108 70 03
5	99 9116 50 05	99 9116 60 05	99 9116 70 05
8	99 9128 50 08	99 9128 60 08	99 9128 70 08
12	99 9136 50 12	99 9136 60 12	99 9136 70 12

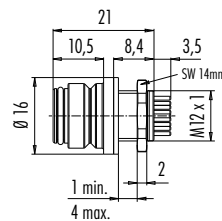

Adapter for panel mount connector

### Ordering-No.

08 2433 400 001

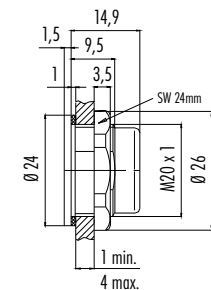

### Component part drawing

Cable connectors

Male insert  
Female insert  
Sleeve  
Seal  
Pinch ring  
Pressing screw

Panel mount connectors solder/dip-solder

Male insert  
Female insert  
Flat seal  
Hexagonal nut

Adapter

Adapter  
Flat seal  
Hexagonal nut

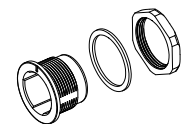
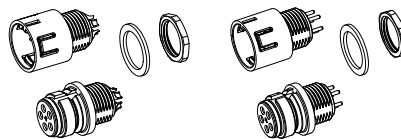
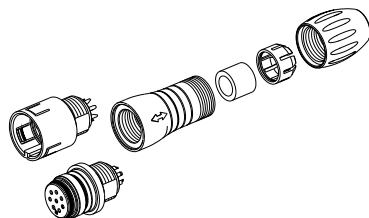



- Bayonet locking system
- 8 contacts
- Degree of protection IP67
- Solder termination
- > 5000 Mating cycles
- Panel mount connector: Degree of protection IP67 even when not connected
- Colour in greywhite similar to RAL 9002

Description	Drawing	Contacts	Cable outlet 2,5–4 mm	Cable outlet 4–6 mm
Male cable connector		8	99 0771 400 08	99 0771 401 08

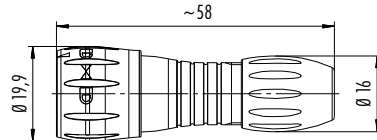

Male cable connector

Contacts	Cable outlet 6–8 mm
8	99 0771 402 08

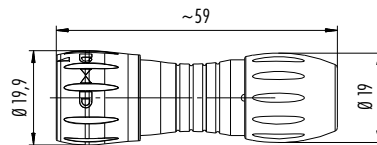

**Ordering-No.**

Female panel mount connector, solder	8	09 0774 400 08
--------------------------------------	---	----------------

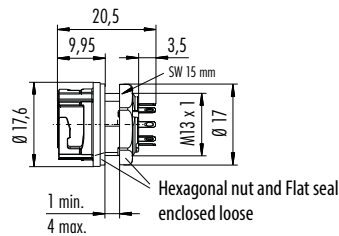

Female panel mount connector, dip-solder

8	09 0774 490 08
---	----------------

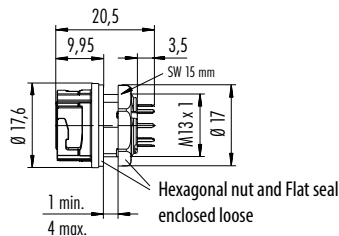

**Specifications**

Contacts	8
Wire gauge	0,25 mm <sup>2</sup> (AWG 24)
Mechanical operation	> 5000 Mating cycles
Temperature range	-25 °C / + 85 °C
Rated voltage	175 V
Pollution degree	2
Rated current (40°C)	2 A
Contact plating	Au (Gold)
Material of housing	PA

## Component part drawing

Cable connector

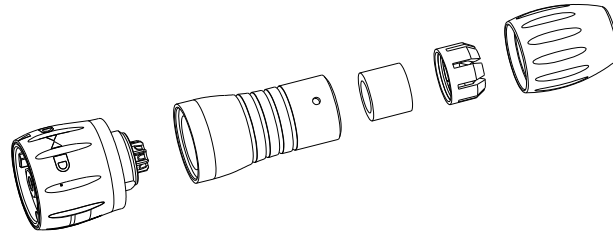

Male insert  
Sleeve  
Seal  
Pinch ring  
Pressing screw

Panel mount connector

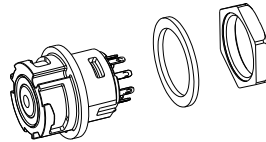

Female insert  
Panel mount connector housing  
with colour coding  
Flat seal  
Hexagonal nut

## Contact arrangement male insert (termination side)

8 contacts

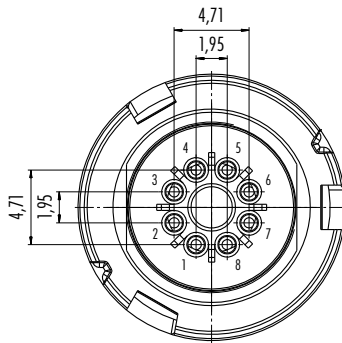

## Contact arrangement female insert (termination side)

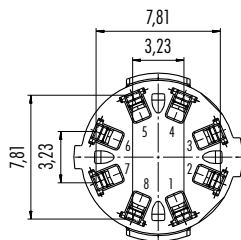

## Panel cut out

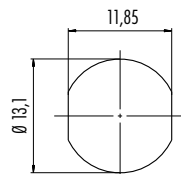



- Screw locking acc. to DIN EN 61076-2-105
- 3 and 4 contacts
- Degree of protection IP67
- Moulded versions
- Thread nut with immunity to vibration
- PUR cable

### Description

Male cable connector, moulded, M5 x 0,5

### Drawing

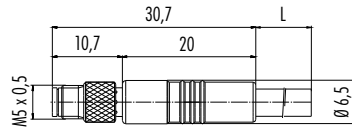

Contacts	Cable length, PUR	Unshielded	Shielded
3 x 0,14	2 m	79 3101 52 03	79 3121 52 03
	5 m	79 3101 55 03	79 3121 525 03
3 x 0,25	2 m	79 3101 32 03	–
	5 m	79 3101 35 03	–
4 x 0,14	2 m	79 3107 52 04	79 3127 52 04
	5 m	79 3107 55 04	79 3127 525 04
4 x 0,25	2 m	79 3107 32 04	–
	5 m	79 3107 35 04	–

Male angled connector, moulded, M5 x 0,5

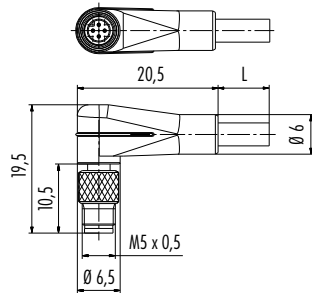

3 x 0,14	2 m	79 3103 52 03
	5 m	79 3103 55 03
3 x 0,25	2 m	79 3103 32 03
	5 m	79 3103 35 03
4 x 0,14	2 m	79 3109 52 04
	5 m	79 3109 55 04
4 x 0,25	2 m	79 3109 32 04
	5 m	79 3109 35 04

Female cable connector, moulded, M5 x 0,5

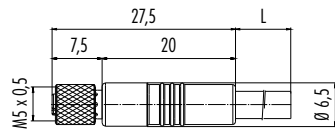

3 x 0,14	2 m	79 3102 52 03	79 3122 52 03
	5 m	79 3102 55 03	79 3122 525 03
3 x 0,25	2 m	79 3102 32 03	–
	5 m	79 3102 35 03	–
4 x 0,14	2 m	79 3108 52 04	79 3128 52 04
	5 m	79 3108 55 04	79 3128 525 04
4 x 0,25	2 m	79 3108 32 04	–
	5 m	79 3108 35 04	–

Female angled connector, moulded, M5 x 0,5

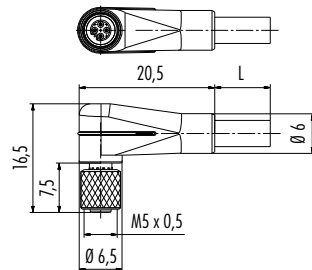

3 x 0,14	2 m	79 3104 52 03
	5 m	79 3104 55 03
3 x 0,25	2 m	79 3104 32 03
	5 m	79 3104 35 03
4 x 0,14	2 m	79 3110 52 04
	5 m	79 3110 55 04
4 x 0,25	2 m	79 3110 32 04
	5 m	79 3110 35 04

### Specifications

Contacts	3	4
Wire gauge	0,14 mm <sup>2</sup> (AWG 26), 0,25 mm <sup>2</sup> (AWG 24)	
Mechanical operation	> 100 Mating cycles	
Temperature range	– 25 °C / + 80 °C	
Rated voltage	60 V	
Pollution degree	3	
Rated current (40°C)	1 A	
Contact plating	Au (Gold)	
Material of housing	PUR	



### Description

### Drawing

### Contacts

### Ordering-No.

Male panel mount connector, with single wires

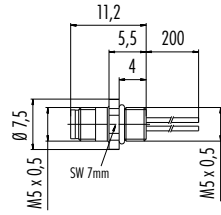

3 x 0,14	09 3105 00 03
3 x 0,25	09 3105 01 03
4 x 0,14	09 3111 00 04
4 x 0,25	09 3111 01 04

Male panel mount connector, front fastened, with single wires

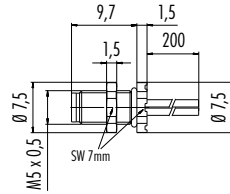

3 x 0,14	09 3105 86 03
4 x 0,14	09 3111 86 04

Male panel mount connector, dip-solder

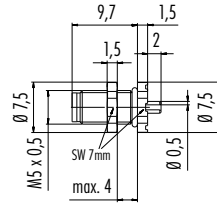

3	09 3105 81 03
4	09 3111 81 04

Female panel mount connector, with single wires

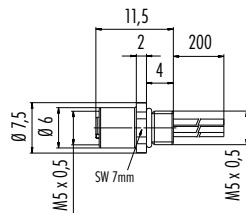

3 x 0,14	09 3106 00 03
3 x 0,25	09 3106 01 03
4 x 0,14	09 3112 00 04
4 x 0,25	09 3112 01 04

Female panel mount connector, front fastened, with single wires

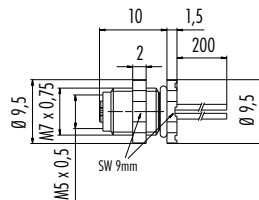

3 x 0,14	09 3106 86 03
4 x 0,14	09 3112 86 04

Female panel mount connector, dip-solder

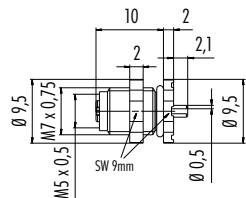

3	09 3106 81 03
4	09 3112 81 04

Description	Drawing	Contacts	Black
Male receptacle for sensor tubes, tube- $\varnothing$ 3,75-H7		4	09 3111 71 04

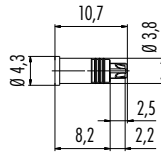

**Contact arrangements male insert (mating side)**

3 contacts



4 contacts



**Contact arrangements female insert (mating side)**



**Colour of wire, moulded cable and panel mount connectors**

- 1 brown
- 2 white
- 3 blue
- 4 black

**Panel cut out**



Description	Drawing	Ordering-No.
M5 Protection cap for female connector		08 2610 000 000

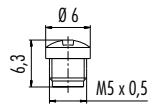

Hexagonal nut M5 x 0,5		01 5118 001
------------------------	--	-------------

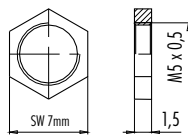





- Screw locking acc. to DIN EN 61076-2-104
- Degree of protection IP67
- Moulded versions
- Easy Assembly
- Excellent EMC shielding (versions with shielding rings 360°)
- Versions with shielding rings/iris type spring
- Angled connectors adjustable in 2/4 positions

Description	Drawing	Contacts	Cable outlet	Ordering-No.
Male cable connector, solder		3	3,5–5 mm	99 3379 00 03
		4		99 3383 00 04

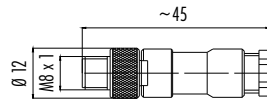

Male cable connector, screw		3	3,5–5 mm	99 3379 100 03
		4		99 3383 100 04

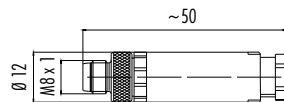

Male cable connector, biatec®		3	3–5 mm	99 3379 400 03
		4		99 3383 400 04

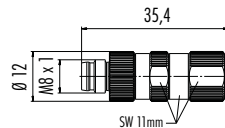

Description	Drawing	Contacts	Wire gauge	Ordering-No.
		Male cable connector, IDT connection		3
3	0,25–0,5 mm <sup>2</sup>			99 3379 550 03
4	0,08–0,25 mm <sup>2</sup>			99 3383 500 04
4	0,25–0,5 mm <sup>2</sup>			99 3383 550 04

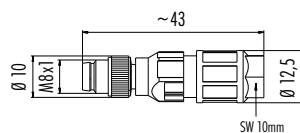

Specifications	Cable connector
Contacts	3 4
Wire gauge	solder 0,25 mm <sup>2</sup> (AWG 24), screw 0,14 mm <sup>2</sup> –0,5 mm <sup>2</sup> (AWG 26–20), biatec® 0,14–0,38 mm <sup>2</sup> (AWG 26–22)
Mechanical operation	> 100 Mating cycles
Temperature range	solder, screw –40 °C /+ 80 °C, IDT connection, biatec® –25 °C /+ 80 °C, moulded –25 °C /+ 85 °C
Rated voltage	60 V (30 V UL)
Pollution degree	3
Rated current (40°C)	4 A
Contact plating	Au (Gold)
Material of housing	PBT/PA/CuZn (brass)

Description	Drawing	Contacts	Cable outlet	Ordering-No.
Male cable connector, solder, shieldable		3	2-3,5 mm	99 3361 25 03
			3,5-5 mm	99 3361 00 03
		4	2-3,5 mm	99 3363 25 04
			3,5-5 mm	99 3363 00 04



Male cable connector, screw clamp termination, iris type spring, shieldable	3		99 3361 100 03
	4	3,5-5,5 mm	99 3363 100 04

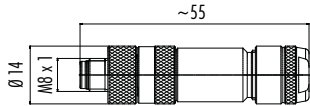

Male cable connector, screw clamp termination, with shielding ring, shieldable	3		99 3361 300 03
	4	6-8 mm	99 3363 300 04

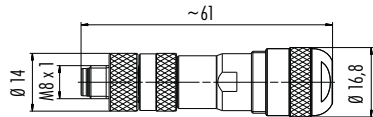

### Component part drawing/Assembly instruction

Cable connector, solder

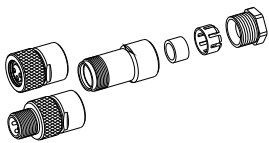

Female insert/  
Male insert  
Sleeve  
Seal  
Pinch ring  
Pressing screw

Cable connector, screw

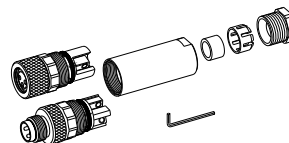

Female insert/  
Male insert  
Sleeve  
Seal  
Pinch ring  
Pressing screw

Hexagonal nut added

Cable connector, solder, shieldable

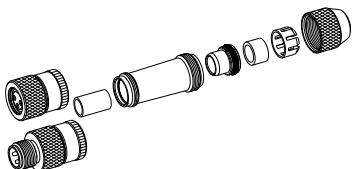

Female insert/  
Male insert  
Insulation sleeve  
Sleeve  
Shielding ring  
O-ring  
Seal  
Pinch ring  
Pressing screw

Cable connector, biatec®

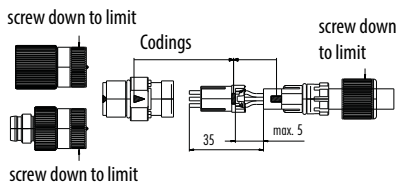

Cable connector, IDT connection

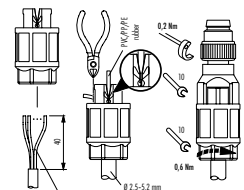

Wire cross section  
0,08-0,25 mm<sup>2</sup>, 0,25-0,50 mm<sup>2</sup>

Cable connector, screw clamp termination, iris type spring, shieldable

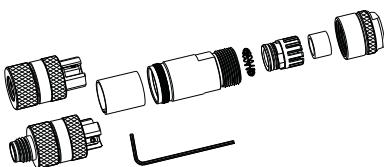

Female insert/  
Male insert  
Insulating sleeve,  
Housing, Iris type spring,  
O-ring, Pinch ring, Seal,  
Pressing screw  
are premounted

Hexagonal nut added

Cable connector, screw clamp termination, shieldable

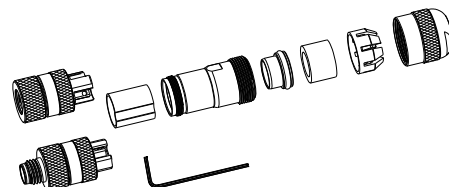

Female insert/  
Male insert  
Insulating sleeve,  
Housing,  
Shielding ring, O-ring,  
Seal, Pinch ring,  
Pressing screw  
are premounted

Hexagonal nut added

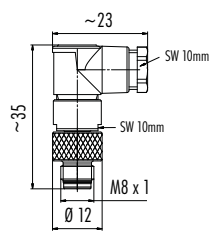
Description	Drawing	Contacts	Cable outlet	Ordering-No.
Male angled connector, solder		3	3,5–5 mm	99 3385 00 03
		4		99 3387 00 04

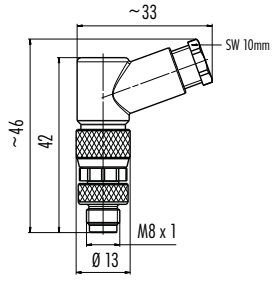

Male angled connector, screw clamp termination		3	3,5–5 mm	99 3379 110 03
		4		99 3383 110 04

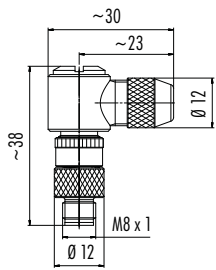

Male angled connector, solder, shieldable		3	3,5–5 mm	99 3365 00 03
		4		99 3367 00 04



### Component part drawing

Angled connector, solder

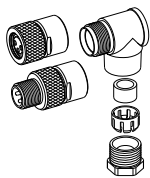

Female insert/  
Male insert  
Angled housing  
Seal  
Pinch ring  
Pressing screw  
Cable outlet adjustable  
in 4 positions

Angled connector, solder, shieldable

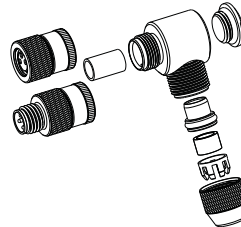

Female insert/  
Male insert  
Insulation sleeve  
Angled housing  
Locking screw  
O-ring, Shielding ring  
O-ring, Seal  
Pinch ring  
Pressing screw  
Cable outlet adjustable  
in 4 positions



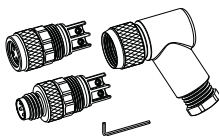





Angled connector, screw

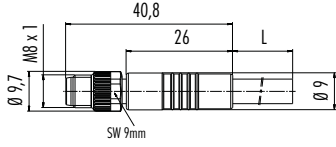

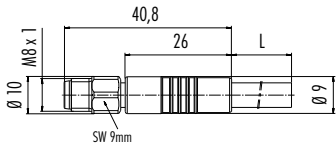
Female insert/  
Male insert  
Angled housing  
Cable outlet adjustable  
in 2 positions  
  
Hexagonal nut added

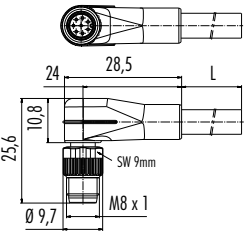
### Colour of wire, moulded cable and panel mount connectors

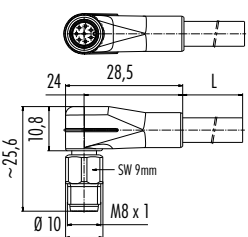
3 contacts	4, 5, 6 contacts	8 contacts
1 brown	1 brown	1 white
2 not connected	2 white	2 brown
3 blue	3 blue	3 green
4 black	4 black	4 yellow
	5 grey	5 grey
	6 pink	6 pink
		7 blue
		8 red

Description	Drawing	Contacts	Cable jacket	Cable length	Ordering-No.	
Male cable connector, moulded, screw version, M8 x 1	  	3 x 0,34	PVC	2 m	77 3405 0000 20003-0200	
					5 m	77 3405 0000 20003-0500
			PUR	2 m	77 3405 0000 50003-0200	
					5 m	77 3405 0000 50003-0500
		4 x 0,34	PVC	2 m	77 3405 0000 20004-0200	
					5 m	77 3405 0000 20004-0500
			PUR	2 m	77 3405 0000 50004-0200	
					5 m	77 3405 0000 50004-0500
		6 x 0,25	PUR	2 m	77 3405 0000 50006-0200	
					5 m	77 3405 0000 50006-0500
			8 x 0,25	PUR	2 m	77 3405 0000 50008-0200
						5 m
Male cable connector, moulded, screw version, M8 x 1, stainless steel locking ring	  	3 x 0,34		PVC	2 m	77 3705 0000 20003-0200
						5 m
			PUR	2 m	77 3705 0000 50003-0200	
					5 m	77 3705 0000 50003-0500
		4 x 0,34	PVC	2 m	77 3705 0000 20004-0200	
					5 m	77 3705 0000 20004-0500
			PUR	2 m	77 3705 0000 50004-0200	
					5 m	77 3705 0000 50004-0500
		6 x 0,25	PUR	2 m	77 3705 0000 50006-0200	
					5 m	77 3705 0000 50006-0500
			8 x 0,25	PUR	2 m	77 3705 0000 50008-0200
						5 m
Male angled connector, moulded, screw version, M8 x 1	  	3 x 0,34		PVC	2 m	77 3403 0000 20003-0200
						5 m
			PUR	2 m	77 3403 0000 50003-0200	
					5 m	77 3403 0000 50003-0500
		4 x 0,34	PVC	2 m	77 3403 0000 20004-0200	
					5 m	77 3403 0000 20004-0500
			PUR	2 m	77 3403 0000 50004-0200	
					5 m	77 3403 0000 50004-0500
		6 x 0,25	PUR	2 m	77 3403 0000 50006-0200	
					5 m	77 3403 0000 50006-0500
			8 x 0,25	PUR	2 m	77 3403 0000 50008-0200
						5 m
Male angled connector, moulded, screw version, M8 x 1, stainless steel locking ring	  	3 x 0,34		PVC	2 m	77 3703 0000 20003-0200
						5 m
			PUR	2 m	77 3703 0000 50003-0200	
					5 m	77 3703 0000 50003-0500
		4 x 0,34	PVC	2 m	77 3703 0000 20004-0200	
					5 m	77 3703 0000 20004-0500
			PUR	2 m	77 3703 0000 50004-0200	
					5 m	77 3703 0000 50004-0500
		6 x 0,25	PUR	2 m	77 3703 0000 50006-0200	
					5 m	77 3703 0000 50006-0500
			8 x 0,25	PUR	2 m	77 3703 0000 50008-0200
						5 m

Specifications	Cable connector, moulded			
Contacts	3	4	6	8
Wire gauge	0,34 mm <sup>2</sup> (AWG 22)		0,25 mm <sup>2</sup> (AWG 24)	
Mechanical operation	> 100 Mating cycles			
Temperature range	-25 °C / + 85 °C			
Rated voltage	60 V, 10-30 V with LED		30 V	
Pollution degree	3			
Rated current (40°C)	4 A		1,5 A	
Contact plating	Au (Gold)			
Material of housing	PUR			

Specifications	Standard Cable			
Contacts	3	4	6	8
Wire gauge	3 x 0,34 mm <sup>2</sup> (AWG 22)		4 x 0,34 mm <sup>2</sup> (AWG 22)	
Material jacket	PVC	PUR	PVC	PUR
Insulation of wire	PVC	PP	PVC	PP
Remark	In chain flex application or when stressed mechanically +60 °C.			
Approval	UL/CSA			
UL-style	PVC: AWM 2517		PUR: AWM 20549	

<sup>1)</sup> Standard cable length is 2 m/5 m. Other lengths upon request.

Description	Drawing	Contacts	Cable outlet	Ordering-No.
Female cable connector, solder		3	3,5–5 mm	99 3400 00 03
		4		99 3376 00 04



Female cable connector, screw		3	3,5–5 mm	99 3400 100 03
		4		99 3376 100 04



Female cable connector, biatec®		3	3–5 mm	99 3400 400 03
		4		99 3376 400 04



Description	Contacts	Wire gauge	Ordering-No.
		Female cable connector, IDT connection	3
	4	0,08–0,25 mm <sup>2</sup> 0,25–0,5 mm <sup>2</sup>	99 3376 500 04 99 3376 550 04



### Contact arrangements male insert (mating side)

3 contacts    4 contacts    5 contacts    6 contacts    8 contacts

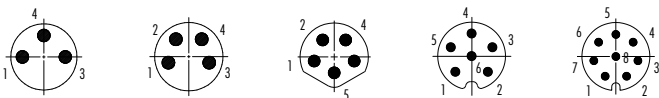

### Contact arrangements female insert (mating side)

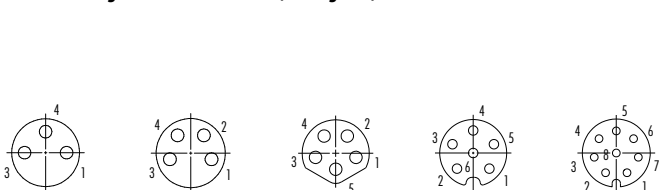







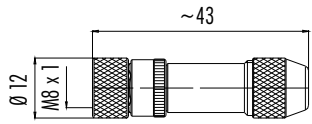
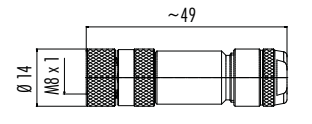
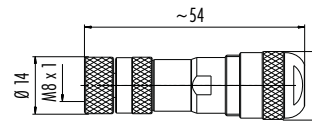
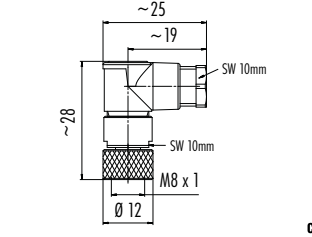
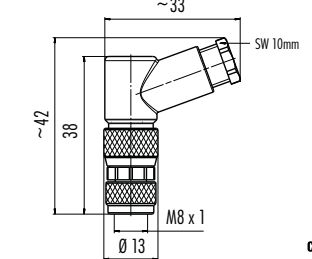
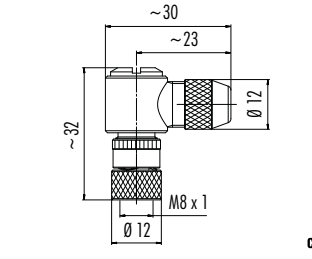

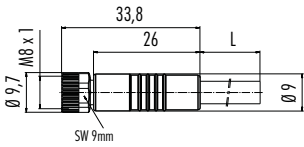

### Colour of wire, moulded cable and panel mount connectors

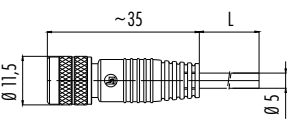
3 contacts	4, 5, 6 contacts	5 contacts 09 3425 XXX 05, 09 3424 XXX 05	8 contacts
1 brown	1 brown	1 grey	1 white
2 not connected	2 white	2 red	2 brown
3 blue	3 blue	3 black	3 green
4 black	4 black	4 white	4 yellow
	5 grey	5 blue	5 grey
	6 pink		6 pink
			7 blue
			8 red

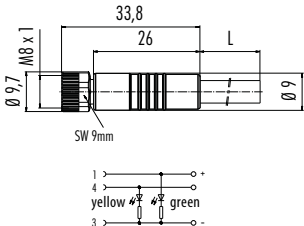

Description	Drawing	Contacts	Cable outlet	Ordering-No.
Female cable connector, solder, shieldable		3 4	2-3,5 mm 3,5-5 mm 2-3,5 mm 3,5-5 mm	99 3360 25 03 99 3360 00 03 99 3362 25 04 99 3362 00 04
Female cable connector, screw clamp termination, iris type spring, shieldable		3 4	3,5-5,5 mm	99 3360 100 03 99 3362 100 04
Female cable connector, screw clamp termination, with shielding ring, shieldable		3 4	6-8 mm	99 3360 300 03 99 3362 300 04
Female angled connector, solder		3 4	3,5-5 mm	99 3402 00 03 99 3378 00 04
Female angled connector, screw clamp termination		3 4	3,5-5 mm	99 3400 110 03 99 3376 110 04
Female angled connector, solder, shieldable		3 4	3,5-5 mm	99 3364 00 03 99 3366 00 04

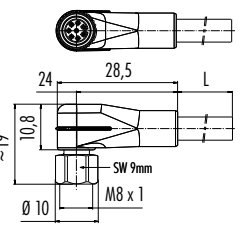
Description	Drawing	Contacts	Cable jacket	Cable length	Ordering-No.			
Female cable connector, moulded, screw version, M8 x 1	 	3 x 0,34	PVC	2 m	77 3406 0000 20003-0200			
				5 m	77 3406 0000 20003-0500			
			PUR	2 m	77 3406 0000 50003-0200			
				5 m	77 3406 0000 50003-0500			
			4 x 0,34	PVC	2 m	77 3406 0000 20004-0200		
					5 m	77 3406 0000 20004-0500		
		PUR	2 m	77 3406 0000 50004-0200				
			5 m	77 3406 0000 50004-0500				
		6 x 0,25	PUR	2 m	77 3406 0000 50006-0200			
				5 m	77 3406 0000 50006-0500			
		8 x 0,25	PUR	2 m	77 3406 0000 50008-0200			
				5 m	77 3406 0000 50008-0500			
Female cable connector, moulded, screw version, M8 x 1, stainless steel locking ring	 	3 x 0,34	PVC	2 m	77 3706 0000 20003-0200			
				5 m	77 3706 0000 20003-0500			
			PUR	2 m	77 3706 0000 50003-0200			
				5 m	77 3706 0000 50003-0500			
			4 x 0,34	PVC	2 m	77 3706 0000 20004-0200		
					5 m	77 3706 0000 20004-0500		
		PUR	2 m	77 3706 0000 50004-0200				
			5 m	77 3706 0000 50004-0500				
		6 x 0,25	PUR	2 m	77 3706 0000 50006-0200			
				5 m	77 3706 0000 50006-0500			
		8 x 0,25	PUR	2 m	77 3706 0000 50008-0200			
				5 m	77 3706 0000 50008-0500			
Female cable connector, moulded, screw version, M8 x 1, shielded	 	3 x 0,34	PUR	2 m	77 3506 0000 50003-0200			
				5 m	77 3506 0000 50003-0500			
		4 x 0,34		2 m	77 3506 0000 50004-0200			
				5 m	77 3506 0000 50004-0500			
		Female cable connector, moulded, screw version, M8 x 1, LED, PNP		 	3 x 0,34	PVC	2 m	77 3606 0000 20003-0200
							5 m	77 3606 0000 20003-0500
PUR	2 m		77 3606 0000 50003-0200					
	5 m		77 3606 0000 50003-0500					
Female angled connector, moulded, screw version, M8 x 1	 		3 x 0,34			PVC	2 m	77 3408 0000 20003-0200
							5 m	77 3408 0000 20003-0500
		PUR		2 m	77 3408 0000 50003-0200			
				5 m	77 3408 0000 50003-0500			
		4 x 0,34	PVC	2 m	77 3408 0000 20004-0200			
				5 m	77 3408 0000 20004-0500			
			PUR	2 m	77 3408 0000 50004-0200			
				5 m	77 3408 0000 50004-0500			
		6 x 0,25	PUR	2 m	77 3408 0000 50006-0200			
				5 m	77 3408 0000 50006-0500			
		8 x 0,25	PUR	2 m	77 3408 0000 50008-0200			
				5 m	77 3408 0000 50008-0500			
Female angled connector, moulded, screw version, M8 x 1, stainless steel locking ring	 	3 x 0,34	PVC	2 m	77 3708 0000 20003-0200			
				5 m	77 3708 0000 20003-0500			
			PUR	2 m	77 3708 0000 50003-0200			
				5 m	77 3708 0000 50003-0500			
		4 x 0,34	PVC	2 m	77 3708 0000 20004-0200			
				5 m	77 3708 0000 20004-0500			
			PUR	2 m	77 3708 0000 50004-0200			
				5 m	77 3708 0000 50004-0500			
		6 x 0,25	PUR	2 m	77 3708 0000 50006-0200			
				5 m	77 3708 0000 50006-0500			
		8 x 0,25	PUR	2 m	77 3708 0000 50008-0200			
				5 m	77 3708 0000 50008-0500			

Description	Drawing	Contacts	Cable jacket	Cable length	Ordering-No.
Female angled connector, moulded, screw version, M8 x 1, shielded		3 x 0,34	PUR	2 m	77 3508 0000 50003-0200
				5 m	77 3508 0000 50003-0500
		4 x 0,34		2 m	77 3508 0000 50004-0200
				5 m	77 3508 0000 50004-0500



Female angled connector, moulded, screw version, M8 x 1, LED, PNP		3 x 0,34	PVC	2 m	77 3608 0000 20003-0200	
				5 m	77 3608 0000 20003-0500	
		4 x 0,34		PUR	2 m	77 3608 0000 50003-0200
					5 m	77 3608 0000 50003-0500
		PVC		2 m	77 3608 0000 20004-0200	
				5 m	77 3608 0000 20004-0500	
PUR	2 m	77 3608 0000 50004-0200				
	5 m	77 3608 0000 50004-0500				

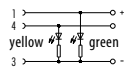
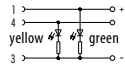

Description	Contacts	Ordering-No.
Male receptacle, short version, dip-solder, without LED	3	09 3413 150 03
	4	09 3415 150 04

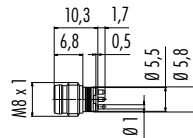

Male receptacle, solder/for M8 tube	3	09 3413 00 03
	3 + LED red	09 3413 40 03
	3 + LED yellow	09 3413 41 03
	3 for M8 tube	09 3411 70 03
	4	09 3415 00 04
	4 + LED red	09 3415 40 04
	4 + LED yellow	09 3415 41 04
	4 for M8 tube	09 3389 70 04

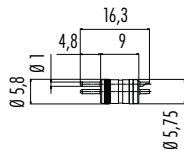
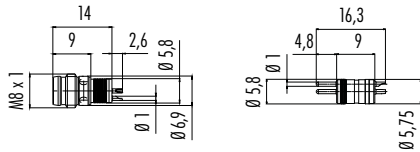

Description	Contacts	Fastened from back side	Front fastened
Male panel mount connector, with single wires	3 x 0,25	09 3403 00 03	09 3403 86 03
	4 x 0,25	09 3391 00 04	09 3391 86 04
	6 x 0,14	09 3463 00 06	09 3463 86 06
	8 x 0,14	09 3487 00 08	09 3487 86 08

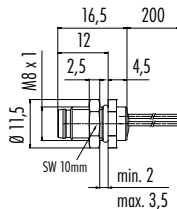
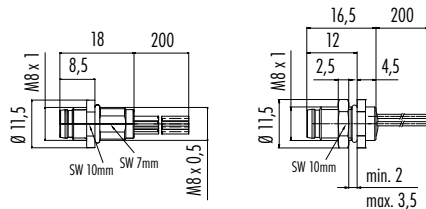

fastened from back side

front fastened

Specifications	Panel mount connector				
	3	4	5	6	8
Contacts	3	4	5	6	8
Wire gauge	0,25 mm <sup>2</sup> (AWG 24)			0,14 mm <sup>2</sup> (AWG 26)	
Mechanical operation	> 100 Mating cycles				
Temperature range	-40 °C / + 85 °C				
Rated voltage	60 V			30 V	
Pollution degree	3				
Rated current (40°C)	4 A			1,5 A	
Contact plating	Au (Gold)				
Material of housing	CuZn (brass nickel plated), zinc diecasting nickel plated				

<sup>1)</sup> Standard cable length is 2 m/5 m. Other lengths upon request.

### Description

Male panel mount connector, with single wires

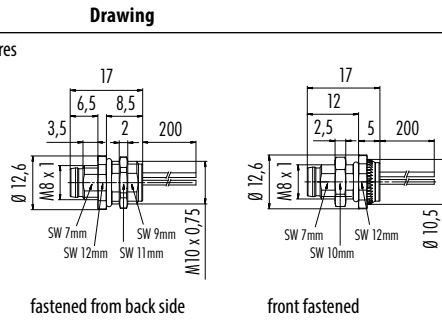

### Contacts

### Fastened from back side

### Front fastened

3 x 0,25	09 3419 00 03	09 3419 86 03
4 x 0,25	09 3421 00 04	09 3421 86 04
5 x 0,25	09 3425 00 05	09 3425 86 05
6 x 0,14	09 3423 00 06	09 3423 86 06
8 x 0,14	09 3427 00 08	09 3427 86 08

Male panel mount connector, front fastened, dip-solder

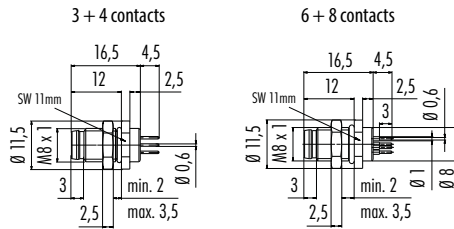

### Contacts

### Ordering-No.

3	09 3403 81 03
4	09 3391 81 04
6	09 3463 81 06
8	09 3487 81 08



Male panel mount connector, front fastened, dip-solder, with shielding sheet

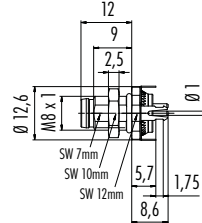

PCB thickness: 1,6 mm

3	09 3419 81 03
4	09 3421 81 04
5	09 3425 81 05
6	09 3423 81 06
8	09 3427 81 08

Male angled panel mount connector, front fastened, dip-solder, with shielding sheet

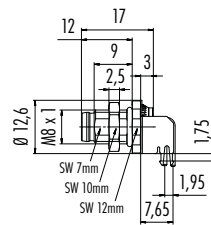

PCB thickness: 1,6 mm

3	09 3419 82 03
4	09 3421 82 04
5	09 3425 82 05
6	09 3423 82 06

Male angled panel mount connector, front fastened, dip-solder

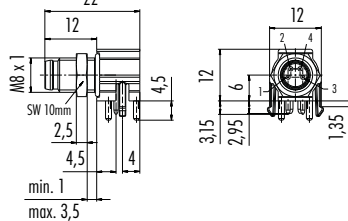

PCB thickness: 1,5 mm



3	99 3403 282 03
4	99 3391 282 04

Male panel mount connector, front fastened, with Ethernet cable

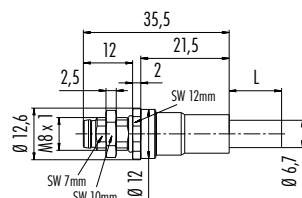

### Contacts

### Cable length

### Ordering-No.

4	0,5 m	70 3421 005 04
---	-------	----------------

### Description

### Drawing

### Contacts

### Fastened from back side

### Front fastened

Female panel mount connector, with single wires/front fastened, with single wires

3 x 0,25	09 3412 00 03		09 3412 86 03
4 x 0,25	09 3390 00 04		09 3390 86 04
6 x 0,14	09 3462 00 06		09 3462 86 06
8 x 0,14	09 3486 00 08		09 3486 86 08

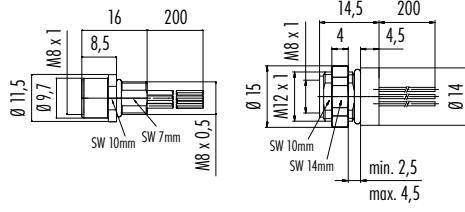

fastened from back side

front fastened

Female panel mount connector, with single wires/front fastened, with single wires

3 x 0,25	09 3418 00 03		09 3418 86 03
4 x 0,25	09 3420 00 04		09 3420 86 04
5 x 0,25	09 3424 00 05		09 3424 86 05
6 x 0,14	09 3422 00 06		09 3422 86 06
8 x 0,14	09 3426 00 08		09 3426 86 08

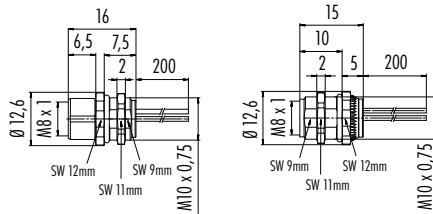

fastened from back side

front fastened

Female panel mount connector, front fastened, dip-solder

Contacts	Contact length	Ordering-No.	
3	9,5 mm	09 3412 80 03	
	4,7 mm	09 3412 187 03	
	0,5 mm	09 3412 186 03	
4	9,5 mm	09 3390 80 04	
	4,7 mm	09 3390 187 04	
6	0,5 mm	09 3390 186 04	
	1,5 mm	09 3462 80 06	
8	1,5 mm	09 3486 80 08	

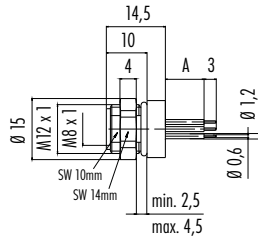

Female panel mount connector, front fastened, dip-solder, with shielding sheet

Contacts	Ordering-No.
3	09 3418 81 03
4	09 3420 81 04
5	09 3424 81 05
6	09 3422 81 06
8	09 3426 81 08

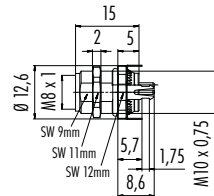

PCB thickness: 1,6 mm

Female angled panel mount connector, front fastened, dip-solder, with shielding sheet

3	09 3418 82 03
4	09 3420 82 04
5	09 3424 82 05
6	09 3422 82 06

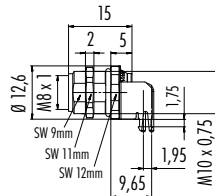

PCB thickness: 1,6 mm

Female panel mount connector, dip-solder, 6 mm/10 mm

Contacts	6 mm	10 mm
3	99 3412 281 03	99 3412 280 03
4	99 3390 281 04	99 3390 280 04

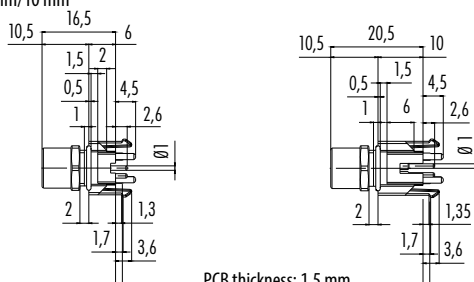

PCB thickness: 1,5 mm



Description	Drawing	Contacts	Ordering-No.
Female angled panel mount connector, front fastened, dip-solder		3	99 3412 282 03
		4	99 3390 282 04



Description	Drawing	Contacts	Cable length	Ordering-No.
Female panel mount connector, front fastened, with Ethernet cable		4	0,5 m	70 3420 005 04



### Panel cut out

Panel mount connector

With flats as anti-rotation device

With bore hole

With thread to screw in

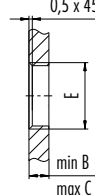
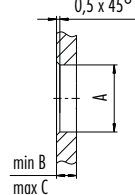
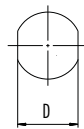

Thread E	A	B	C	D
M8 x 0,5	8,1	2,5	3,5	7,1
M10 x 0,75	10,1	2,5	5,0	9,1

Tightening torque 1 Nm

Panel mount connector, front fastened

With flats as anti-rotation device

With bore hole

With thread to screw in

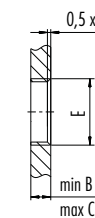
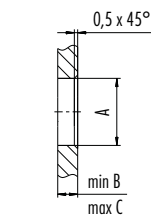
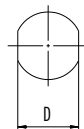

Thread E	A	B	C	D
M8 x 1	8,1	2,0	3,5	7,1
M10 x 0,75	10,1	2,0	6,5	9,1
M12 x 1	12,1	2,5	4,5	10,0

Tightening torque 1 Nm

Description	Drawing	Ordering-No.
Protection cap for male cable connector		08 2840 000 000

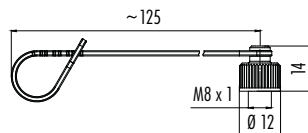

Protection cap for female cable connector		08 2841 000 000
---	--	-----------------

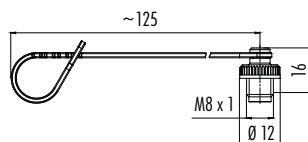

Description	Drawing	Ordering-No.
Protection cap for male panel mount connector		08 2842 000 000
Protection cap for male panel mount connector, for front mounting		08 2972 000 000
Protection cap for female panel mount connector		08 2843 000 000
Protection cap for female panel mount connector, for front mounting		08 2973 000 000
Protection cap for female connector		08 2441 000 000
Dummy plug M10 x 0,75		08 3130 000 000
Hexagonal nut M8 x 0,5		01 0769 001
Mounting tool for M8 locking ring, 0,4 Nm		07 0085 000



- Screw locking acc. to DIN EN 61076-2-101
  - Degree of protection IP67
  - Moulded versions
  - Easy assembly
  - Excellent EMC shielding
  - Versions with shielding rings/iris type spring
  - Angled connectors adjustable in 4 positions
  - Outdoor versions
- Degree of protection IP68/IP69**

**Description**

**Drawing**

Male cable connector, screw clamp, solder termination on contact 12/wire clamp

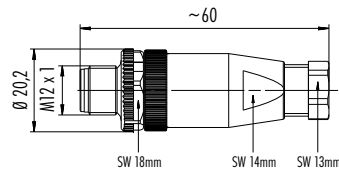

Contacts	Cable outlet	Screw clamp <sup>1)</sup>	Wire clamp
3	4–6 mm	99 0429 07 04	c  US –
	6–8 mm	99 0429 158 04	c  US –
	2,5–3,5 mm	99 0429 314 04	–
4	4–6 mm	99 0429 14 04	c  US 99 0525 14 04
	6–8 mm	99 0429 12 04	c  US 99 0525 12 04
5	4–6 mm	99 0437 14 05	c  US 99 0537 14 05
	6–8 mm	99 0437 12 05	c  US 99 0537 12 05
8	6–8 mm	99 0487 12 08	c  US –
12 <sup>1)</sup>	6–8 mm	99 0491 12 12	c  US –

Male cable connector, stainless steel locking ring, screw clamp

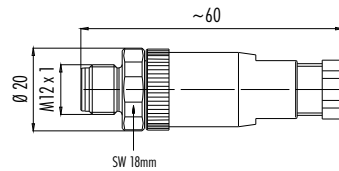

4	4–6 mm	99 0429 82 04	
	6–8 mm	99 0429 282 04	
5	4–6 mm	99 0437 82 05	
	6–8 mm	99 0437 282 05	
8	6–8 mm	99 0487 282 08	



Male cable connector, crimp

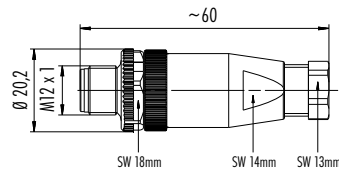

4	4–6 mm	99 0529 14 04	
	6–8 mm	99 0529 12 04	



Crimp contacts see page 112/143

Male cable connector, plastic locking system, screw clamp

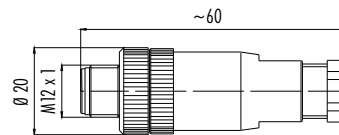

4	4–6 mm	99 0429 43 04	
	6–8 mm	99 0429 57 04	
5	4–6 mm	99 0437 43 05	
	6–8 mm	99 0437 57 05	



**Specifications**

**Cable connector plastic version**

Contacts	3	4	5	8	12
Wire gauge	max. 0,75 mm <sup>2</sup> (max. AWG 20), Power max. 1,5 mm <sup>2</sup> (max. AWG 16), screw clamp 0,14–0,75 mm <sup>2</sup> (AWG 26–18)			max. 0,5 mm <sup>2</sup> (max. AWG 20)	max. 0,25 mm <sup>2</sup> (max. AWG 24)
Mechanical operation	Optalloy > 50 Mating cycles, Gold > 100 Mating cycles			Gold > 100 Mating cycles	
Temperature range	– 40 °C / + 85 °C, Outdoor – 40 °C / + 100 °C, screw clamp – 25 °C / + 80 °C				
Rated voltage	250 V		60 V	30 V	
Pollution degree	3				
Rated current (40°C)	4 A	4 A, Power 8 A	4 A, Power cont. 1-4 8 A, cont. 5 2 A	2 A	1,5 A
Contact plating	screw clamp termination: CuSnZn (Optalloy), others Au (Gold)			Au (Gold)	
Material of housing	PA				



## Description

## Drawing

## Contacts Cable outlet Ordering-No.

Male cable connector, Power

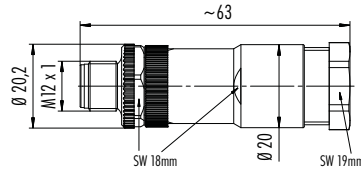

4	8-10 mm	99 0429 19 04
5		99 0437 19 05

Male cable connector, Outdoor, screw clamp, IP68, IP69K

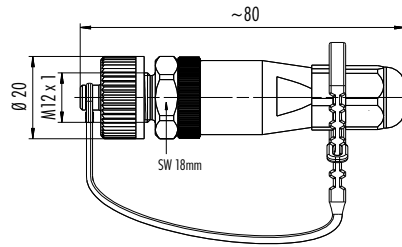

4	4-6,5 mm	99 0429 684 04
---	----------	----------------

Male cable connector, IDT connection

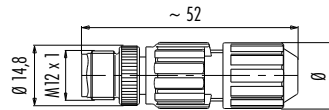

Cable-Ø	Ø
3,5-6	16,3
4-8	18,4

Contacts	Wire gauge	Cable outlet	Ordering-No.
4	0,14-0,34 mm <sup>2</sup>	3,5-6 mm	99 0527 14 04
	0,34-0,75 mm <sup>2</sup>	4-8 mm	99 0527 12 04

Male cable duo connector, screw clamp

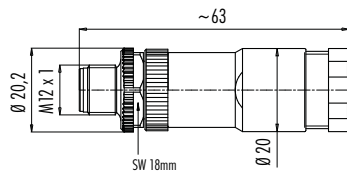

Contacts	Cable outlet	Ordering-No.
4	2 cables	99 0429 186 04
5	2,1-3 mm/	99 0437 186 05
8	4-5 mm	99 0487 186 08

Male cable duo connector, stainless steel locking ring, screw clamp

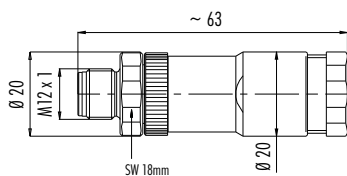

4	2 cables	99 0429 287 04
5	2,1-3 mm/	99 0437 287 05
8	4-5 mm	99 0487 287 08

Male cable duo connector, plastic locking system, screw clamp

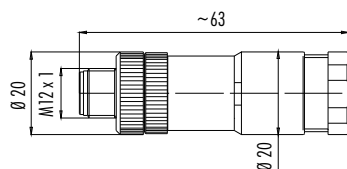

4	2 cables	99 0429 142 04
5	2,1-3 mm/ 4-5 mm	99 0437 142 05

**Description** Male cable connector, screw clamp/wire clamp, with shielding ring, shieldable, solder termination on contact 12

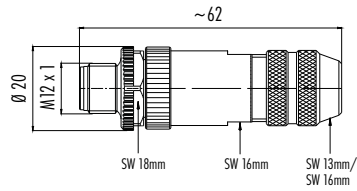

Contacts	Cable outlet	Screw clamp <sup>1)</sup>	Wire clamp
4	4–6 mm	99 1429 814 04	99 1525 814 04
	6–8 mm	99 1429 812 04	99 1525 812 04
5	4–6 mm	99 1437 814 05	99 1537 814 05
	6–8 mm	99 1437 812 05	99 1537 812 05
8	6–8 mm	99 1487 812 08	–
	8–10 mm	99 1487 914 08	–
12 <sup>1)</sup>	6–8 mm	99 1491 812 12	–

Male cable connector, screw clamp/wire clamp, iris type spring, shieldable

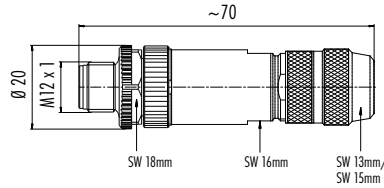

4	5–8 mm	99 1431 814 04	99 1527 814 04
5	5–8 mm	99 1439 814 05	99 1539 814 05
8	5–8 mm	99 1489 814 08	–
	8–9 mm	99 1489 812 08	–

Male cable connector, screw clamp, with shielding ring, stainless steel version, shieldable

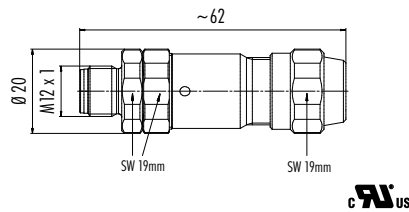

4	3–5,5 mm	99 1429 991 04	
	5,5–8,6 mm	99 1429 992 04	
5	3–5,5 mm	99 1437 991 05	
	5,5–8,6 mm	99 1437 992 05	
8	5,5–8,6 mm	99 1487 992 08	

Male cable connector, crimp, shieldable

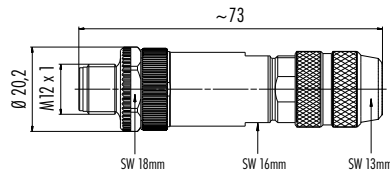

4	5–8 mm	99 1433 814 04	
---	--------	----------------	--

Crimp contacts see page 112/143

Single contact (Male), PU 100 pieces

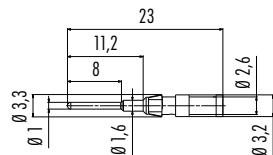

Wire gauge	AWG	Ordering-No.
0,14 mm <sup>2</sup> – 0,34 mm <sup>2</sup>	26–22	61 1224 146
0,34 mm <sup>2</sup> – 0,5 mm <sup>2</sup>	22–20	61 1154 146
0,75 mm <sup>2</sup> – 1,0 mm <sup>2</sup>	18–16	61 1225 146
1,0 mm <sup>2</sup> – 1,5 mm <sup>2</sup>	16	61 1226 146

Specifications	Cable connector metal version			
Contacts	4	5	8	12
Wire gauge	screw clamp max. 0,75 mm <sup>2</sup> (max. AWG 20), wire clamp max. 0,5 mm <sup>2</sup> (max. AWG 20)		max. 0,5 mm <sup>2</sup> (max. AWG 20)	max. 0,25 mm <sup>2</sup> (max. AWG 24)
Mechanical operation	> 100 Mating cycles			
Temperature range	– 40 °C / + 85 °C			
Rated voltage	250 V	60 V	30 V	
Degree of contamination	3			
Rated current (40°C)	4 A		2 A	1,5 A
Contact plating	Au (Gold)			
Material Housing	straight, shielded version CuZn (brass nickel plated), angled shielded versions zinc diecasting nickel plated			

**Description**

**Drawing**

**Contacts**

**Cable outlet**

**Screw clamp <sup>1)</sup>**

**Wire clamp**

Male angled connector, screw clamp, solder termination on contact 12/wire clamp

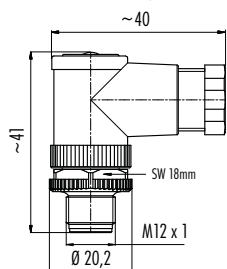

3	4-6 mm	99 0429 27 04		-
	6-8 mm	99 0429 161 04		-
4	2,5-3,5 mm	99 0429 324 04		-
	4-6 mm	99 0429 24 04		99 0525 24 04
	6-8 mm	99 0429 52 04		99 0525 52 04
5	4-6 mm	99 0437 24 05		99 0537 24 05
	6-8 mm	99 0437 52 05		99 0537 52 05
12 <sup>1)</sup>	6-8 mm	99 0491 52 12		-

Male angled connector, stainless steel locking ring, screw clamp

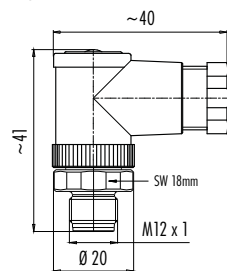

4	4-6 mm	99 0429 92 04		
	6-8 mm	99 0429 292 04		
5	4-6 mm	99 0437 92 05		
	6-8 mm	99 0437 292 05		

Male angled connector, crimp

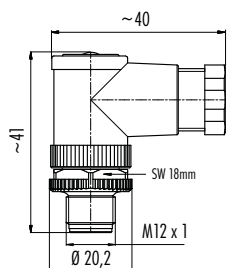

4	4-6 mm	99 0529 24 04		
	6-8 mm	99 0529 52 04		

Crimp contacts see page 112/143

Male angled connector, plastic locking system, screw clamp

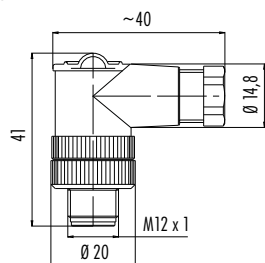

4	4-6 mm	99 0429 44 04		
5	4-6 mm	99 0437 44 05		

Male angled connector, Power

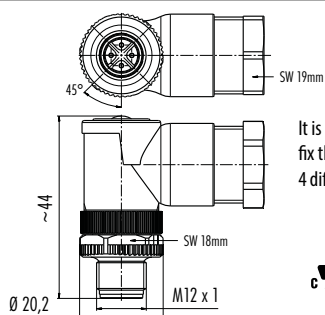

It is possible to turn and fix the contact carrier in 4 different 90° positions



4	8-10 mm	99 0429 58 04		
5		99 0437 58 05		

Duo male angled connector, screw clamp

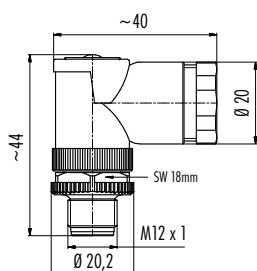

4	2 cables	99 0429 286 04		
5	2,1-3 mm/	99 0437 286 05		
	4-5 mm			

<sup>1)</sup>Version with solder contacts.

Description	Drawing	Contacts	Cable outlet	Ordering-No.
Duo male angled connector, plastic locking system, screw clamp		4	2 cables 2,1–3 mm/	99 0429 162 04
		5	4–5 mm	99 0437 162 05



Male angled connector, screw clamp/wire clamp, with shielding ring, shieldable, solder termination on contact 12

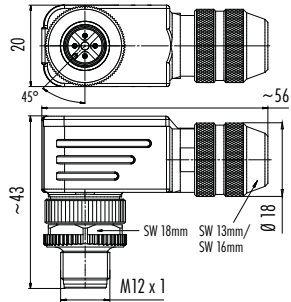

It is possible to turn and fix the contact carrier in 4 different 90° positions

Contacts	Cable outlet	Screw clamp <sup>1)</sup>	Wire clamp
4	4–6 mm	99 1429 824 04	c RA US 99 1525 824 04
	6–8 mm	99 1429 822 04	c RA US 99 1525 822 04
5	4–6 mm	99 1437 824 05	c RA US 99 1537 824 05
	6–8 mm	99 1437 822 05	c RA US 99 1537 822 05
12 <sup>1)</sup>	6–8 mm	99 1491 822 12	c RA US –

Male angled connector, screw clamp/wire clamp, iris type spring, shieldable

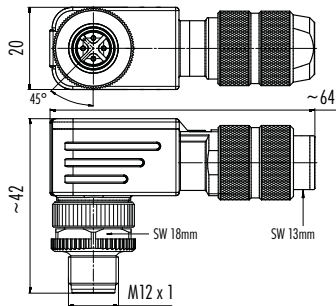

It is possible to turn and fix the contact carrier in 4 different 90° positions

4	5–8 mm	99 1431 824 04	c RA US 99 1527 824 04
5	5–8 mm	99 1439 824 05	c RA US 99 1539 824 05

Male angled connector, crimp, shieldable



4	5–8 mm	99 1433 824 04
---	--------	----------------

Crimp contacts see page 112/143

### Contact arrangements male insert (mating side)

3 contacts

4 contacts

5 contacts/5 contacts CAN-Bus

8 contacts

12 contacts

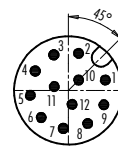
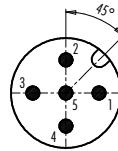
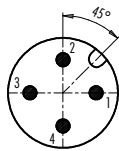
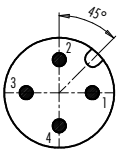

### Contact arrangements female insert (mating side)

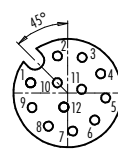
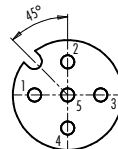
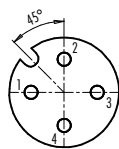
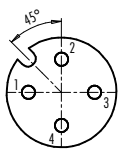

## Colour of wire, moulded cable and panel mount connectors

3-5 contacts	5 contacts CAN-Bus	8 contacts	12 contacts
1 brown	1 Shield	1 white	1 brown
2 not connected/white	2 red (AWG 22)	2 brown	2 blue
3 blue	3 black (AWG 22)	3 green	3 white
4 black	4 white (AWG 24)	4 yellow	4 green
5 grey	5 blue (AWG 24)	5 grey	5 pink
		6 pink	6 yellow
		7 blue	7 black
		8 red	8 grey
			9 red
			10 purple
			11 grey/pink
			12 red/blue

Contact 2 is not connected at 3 pole version.

Shielded versions: Shield on housing or at 8 pole version on contact 8.

## Component part drawing

Cable connectors, not shieldable

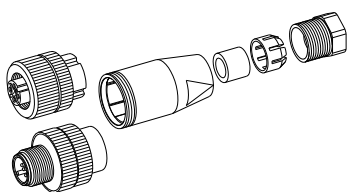

Female insert/  
Male insert  
Sleeve  
Seal  
Pinch ring  
Pressing screw

Cable duo connectors, not shieldable

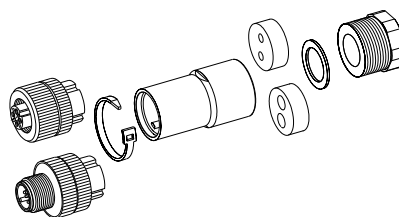

Female insert/  
Male insert  
Cable binder  
Sleeve  
Seal  
Thrust collar  
Pressing screw

Cable connectors, with shielding ring, shieldable

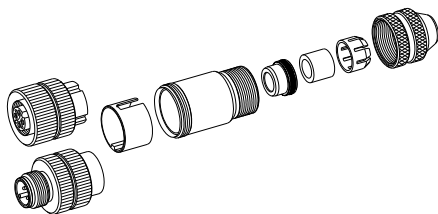

Female insert/  
Male insert  
Insulating sleeve tightly  
built into coupling sleeve  
Shielding ring  
O-ring  
Seal  
Pinch ring  
Pressing screw

Cable connectors, with iris type spring, shieldable

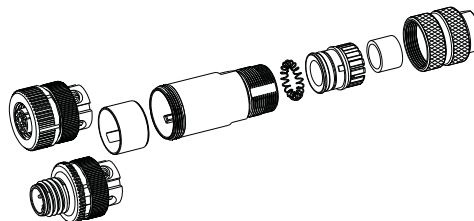

Female insert/  
Male insert  
Insulating sleeve, Sleeve,  
Pressing spring, O-ring,  
Pinch ring, Seal,  
Pressing screw  
are premounted

Angled connectors, not shieldable

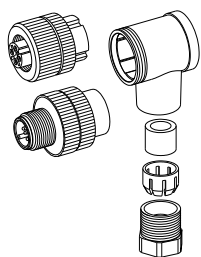

Female insert/  
Male insert  
Angled housing  
Seal  
Pinch ring  
Pressing screw

Duo male angled connectors, not shieldable

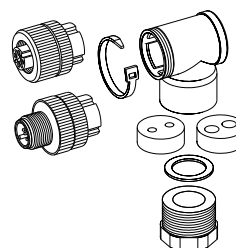

Female insert/  
Male insert  
Cable binder  
Angled housing  
Seal  
Thrust collar  
Pressing screw

Angled connectors, with shielding ring, shieldable

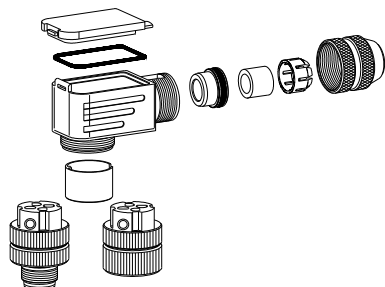

Female insert/  
Male insert  
Insulating sleeve tightly  
built into coupling sleeve  
Housing  
Cover  
Shielding ring  
O-ring  
Seal  
Pinch ring  
Pressing screw

Angled connectors, with iris type spring, shieldable

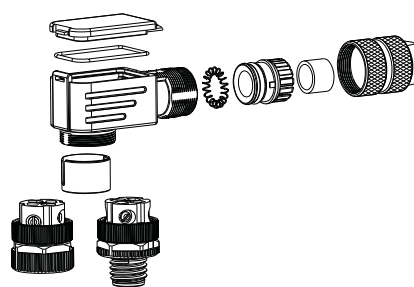

Female insert/  
Male insert  
Insulating sleeve, Housing,  
Pressing spring, O-ring,  
Pinch ring, Seal,  
Pressing screw  
are premounted  
O-ring  
Cover

**Description**

**Drawing**

Male cable connector, moulded, PVC (grey), PUR (black)

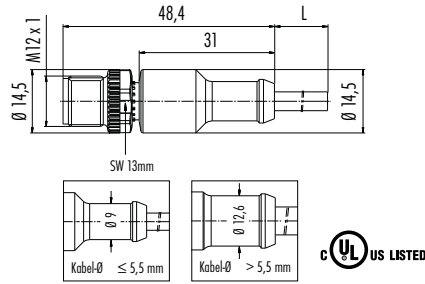

Male cable connector, moulded, shielded, PVC (grey), PUR (black)

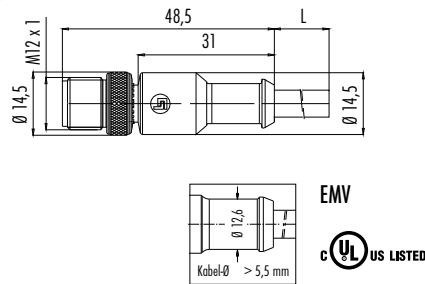

Male cable connector, moulded, PUR, for welding application

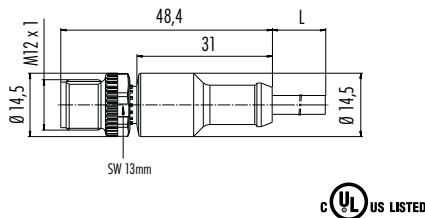

Male cable connector, moulded, PVC (grey), stainless steel locking ring, Food and Beverage

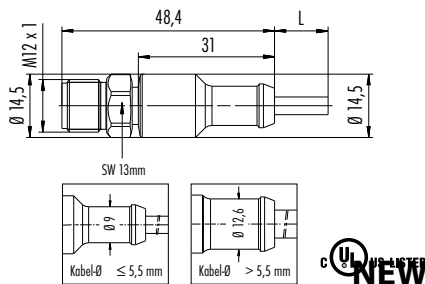

Male cable connector, moulded, PUR, stainless steel locking ring

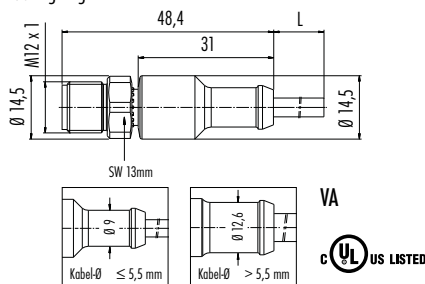

Male cable connector, moulded, PUR (black), Power

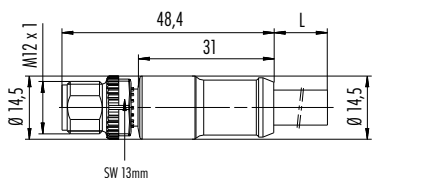

Contacts	Cable length	PVC (cable grey) <sup>1)</sup>	PUR (cable black) <sup>1)</sup>
3 x 0,34	2 m	77 3429 0000 20003-0200	77 3429 0000 50003-0200
	5 m	77 3429 0000 20003-0500	77 3429 0000 50003-0500
4 x 0,34	2 m	77 3429 0000 20004-0200	77 3429 0000 50004-0200
	5 m	77 3429 0000 20004-0500	77 3429 0000 50004-0500
5 x 0,25	2 m	77 3429 0000 20005-0200	77 3429 0000 50005-0200
	5 m	77 3429 0000 20005-0500	77 3429 0000 50005-0500
8 x 0,25 <sup>2)</sup>	2 m	-	77 3429 0000 50608-0200
	5 m	-	77 3429 0000 50608-0500
8 x 0,25	2 m	77 3429 0000 20708-0200	77 3429 0000 50708-0200
	5 m	77 3429 0000 20708-0500	77 3429 0000 50708-0500
12 x 0,25	2 m	77 3429 0000 20712-0200	77 3429 0000 50712-0200
	5 m	77 3429 0000 20712-0500	77 3429 0000 50712-0500

3 x 0,34	2 m	77 3529 0000 20703-0200	77 3529 0000 50703-0200
	5 m	77 3529 0000 20703-0500	77 3529 0000 50703-0500
4 x 0,34	2 m	77 3529 0000 20704-0200	77 3529 0000 50704-0200
	5 m	77 3529 0000 20704-0500	77 3529 0000 50704-0500
5 x 0,25	2 m	77 3529 0000 20705-0200	77 3529 0000 50705-0200
	5 m	77 3529 0000 20705-0500	77 3529 0000 50705-0500
8 x 0,25	2 m	77 3529 0000 20708-0200	77 3529 0000 50708-0200
	5 m	77 3529 0000 20708-0500	77 3529 0000 50708-0500

Contacts	Cable length	PUR (cable orange) <sup>1)</sup>	PUR (cable black) <sup>1)</sup>
3 x 0,34	2 m	77 3429 0000 80003-0200	77 3429 0000 80203-0200
	5 m	77 3429 0000 80003-0500	77 3429 0000 80203-0500
4 x 0,34	2 m	77 3429 0000 80004-0200	77 3429 0000 80204-0200
	5 m	77 3429 0000 80004-0500	77 3429 0000 80204-0500
5 x 0,25	2 m	77 3429 0000 80005-0200	77 3429 0000 80205-0200
	5 m	77 3429 0000 80005-0500	77 3429 0000 80205-0500

Contacts	Cable length	PVC (cable grey) <sup>1)</sup>
3 x 0,34	2 m	77 3729 0000 20403-0200
	5 m	77 3729 0000 20403-0500
4 x 0,34	2 m	77 3729 0000 20404-0200
	5 m	77 3729 0000 20404-0500
5 x 0,34	2 m	77 3729 0000 20405-0200
	5 m	77 3729 0000 20405-0500
8 x 0,25	2 m	77 3729 0000 20908-0200
	5 m	77 3729 0000 20908-0500
12 x 0,25	2 m	77 3729 0000 20912-0200
	5 m	77 3729 0000 20912-0500

Contacts	Cable length	PUR (cable black) <sup>1)</sup>
3 x 0,34	2 m	77 3729 0000 50003-0200
	5 m	77 3729 0000 50003-0500
4 x 0,34	2 m	77 3729 0000 50004-0200
	5 m	77 3729 0000 50004-0500
5 x 0,25	2 m	77 3729 0000 50005-0200
	5 m	77 3729 0000 50005-0500
8 x 0,25	2 m	77 3729 0000 50708-0200
	5 m	77 3729 0000 50708-0500

4 x 1,5	2 m	77 0605 0000 50704-0200
	5 m	77 0605 0000 50704-0500

## Description

Male cable connector, CAN-Bus

## Drawing

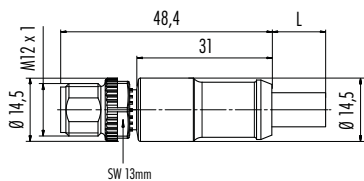

## Contacts Cable length Ordering-No. <sup>1)</sup>

Contacts	Cable length	Ordering-No. <sup>1)</sup>
5	2 m	77 2529 0000 50705-0200
	5 m	77 2529 0000 50705-0500
	10 m	77 2529 0000 50705-1000

Male terminating connector, CAN-Bus

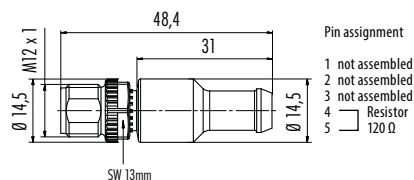

Contacts	Cable length	Ordering-No. <sup>1)</sup>
5	–	77 9839 0000 00005

Specifications	Cable connector, moulded				
Contacts	3	4	5	8	12
Wire gauge	0,34 mm <sup>2</sup> (AWG 22)		0,34 mm <sup>2</sup> (AWG 22), 0,25 mm <sup>2</sup> (AWG 24)	0,25 mm <sup>2</sup> (AWG 24)	
Mechanical operation	> 100 Mating cycles				
Temperature range	- 25 °C /+ 90 °C (+ 80 °C UL), - 40 °C /+ 105 °C				
Rated voltage	250 V		60 V	30 V	
Pollution degree	3				
Rated current (40°C)	4 A			2 A	1 A
Contact plating	Au (Gold)				
Material of housing	PUR/PP				

<sup>1)</sup>Standard cable length is 2 m/5 m. Other lengths upon request.

Description	Drawing	Contacts	Cable length	PVC (cable grey) <sup>1)</sup>	PUR (cable black) <sup>1)</sup>		
Male angled connector, moulded, PVC (grey), PUR (black)		3 x 0,34	2 m	77 3427 0000 20003-0200	77 3427 0000 50003-0200		
			5 m	77 3427 0000 20003-0500	77 3427 0000 50003-0500		
		4 x 0,34	2 m	77 3427 0000 20004-0200	77 3427 0000 50004-0200		
			5 m	77 3427 0000 20004-0500	77 3427 0000 50004-0500		
		5 x 0,25	2 m	77 3427 0000 20005-0200	77 3427 0000 50005-0200		
			5 m	77 3427 0000 20005-0500	77 3427 0000 50005-0500		
		8 x 0,25 <sup>2)</sup>	2 m	-	77 3427 0000 50608-0200		
			5 m	-	77 3427 0000 50608-0500		
		8 x 0,25	2 m	77 3427 0000 20708-0200	77 3427 0000 50708-0200		
			5 m	77 3427 0000 20708-0500	77 3427 0000 50708-0500		
		12 x 0,25	2 m	77 3427 0000 20712-0200	77 3427 0000 50712-0200		
			5 m	77 3427 0000 20712-0500	77 3427 0000 50712-0500		
Male angled connector, moulded, shielded, PVC (grey), PUR (black)		3 x 0,34	2 m	77 3527 0000 20703-0200	77 3527 0000 50703-0200		
			5 m	77 3527 0000 20703-0500	77 3527 0000 50703-0500		
		4 x 0,34	2 m	77 3527 0000 20704-0200	77 3527 0000 50704-0200		
			5 m	77 3527 0000 20704-0500	77 3527 0000 50704-0500		
		5 x 0,25	2 m	77 3527 0000 20705-0200	77 3527 0000 50705-0200		
			5 m	77 3527 0000 20705-0500	77 3527 0000 50705-0500		
		8 x 0,25	2 m	77 3527 0000 20708-0200	77 3527 0000 50708-0200		
			5 m	77 3527 0000 20708-0500	77 3527 0000 50708-0500		
		Male angled connector, moulded, PUR, for welding application		3 x 0,34	2 m	77 3427 0000 80003-0200	77 3427 0000 80203-0200
					5 m	77 3427 0000 80003-0500	77 3427 0000 80203-0500
				4 x 0,34	2 m	77 3427 0000 80004-0200	77 3427 0000 80204-0200
					5 m	77 3427 0000 80004-0500	77 3427 0000 80204-0500
5 x 0,25	2 m			77 3427 0000 80005-0200	77 3427 0000 80205-0200		
	5 m			77 3427 0000 80005-0500	77 3427 0000 80205-0500		
Male angled connector, moulded, PVC (grey), stainless steel locking ring, Food and Beverage				3 x 0,34	2 m	77 3727 0000 20403-0200	
					5 m	77 3727 0000 20403-0500	
				4 x 0,34	2 m	77 3727 0000 20404-0200	
					5 m	77 3727 0000 20404-0500	
				5 x 0,34	2 m	77 3727 0000 20405-0200	
					5 m	77 3727 0000 20405-0500	
		8 x 0,25	2 m	77 3727 0000 20908-0200			
			5 m	77 3727 0000 20908-0500			
		12 x 0,25	2 m	77 3727 0000 20912-0200			
			5 m	77 3727 0000 20912-0500			
		Male angled connector, moulded, PUR, stainless steel locking ring		3 x 0,34	2 m		77 3727 0000 50003-0200
					5 m		77 3727 0000 50003-0500
4 x 0,34	2 m				77 3727 0000 50004-0200		
	5 m				77 3727 0000 50004-0500		
5 x 0,25	2 m				77 3727 0000 50005-0200		
	5 m				77 3727 0000 50005-0500		
8 x 0,25	2 m				77 3727 0000 50708-0200		
	5 m				77 3727 0000 50708-0500		
Male angled connector, moulded, PVC (grey), PUR (black), with LED, PNP				3 x 0,34	2 m	77 3627 0000 20003-0200	77 3627 0000 50003-0200
					5 m	77 3627 0000 20003-0500	77 3627 0000 50003-0500
				4 x 0,34	2 m	77 3627 0000 20004-0200	77 3627 0000 50004-0200
					5 m	77 3627 0000 20004-0500	77 3627 0000 50004-0500



**Description**

**Drawing**

**Contacts**

**Cable outlet**

**Screw clamp <sup>1)</sup>**

**Wire clamp**

Female cable connector, screw clamp, solder termination on contact 12/wire clamp

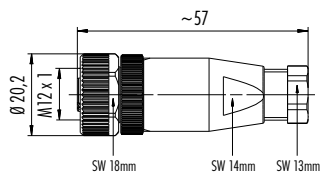

Contacts	Cable outlet	Screw clamp <sup>1)</sup>	Wire clamp
3	4-6 mm	99 0430 07 04	c  US -
	6-8 mm	99 0430 158 04	c  US -
	2,5-3,5 mm	99 0430 314 04	-
4	4-6 mm	99 0430 14 04	c  US 99 0524 14 04
	6-8 mm	99 0430 12 04	c  US 99 0524 12 04
5	4-6 mm	99 0436 14 05	c  US 99 0536 14 05
	6-8 mm	99 0436 12 05	c  US 99 0536 12 05
8	6-8 mm	99 0486 12 08	c  US -
12 <sup>1)</sup>	6-8 mm	99 0492 12 12	c  US -

Female cable connector, stainless steel locking ring, screw clamp

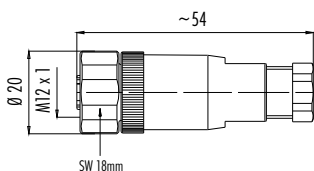

4	4-6 mm	99 0430 82 04	
	6-8 mm	99 0430 282 04	
5	4-6 mm	99 0436 82 05	
	6-8 mm	99 0436 282 05	
8	6-8 mm	99 0486 282 08	



Female cable connector, crimp

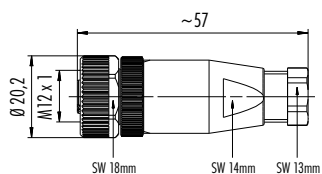

4	4-6 mm	99 0530 14 04	
	6-8 mm	99 0530 12 04	



Crimp contacts see page 121/143

Female cable connector, plastic locking system, screw clamp

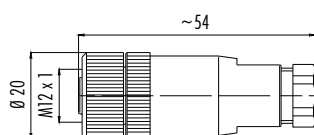

4	4-6 mm	99 0430 10 04	
	6-8 mm	99 0430 30 04	transparent housing
	6-8 mm	99 0430 57 04	
5	4-6 mm	99 0436 10 05	
	6-8 mm	99 0436 57 05	



<sup>1)</sup>Version with solder contacts.

**Description**

**Drawing**

**Contacts**

**Cable outlet**

**Ordering-No.**

Female cable connector, Power

4	8–10 mm	99 0430 19 04
5		99 0436 19 05

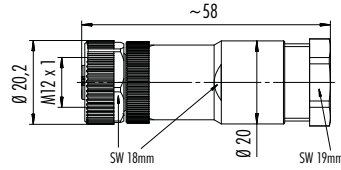

Female cable connector, Outdoor, screw clamp, IP68, IP69K

4	4–6,5 mm	99 0430 684 04
---	----------	----------------

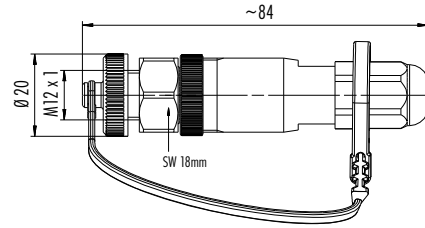

Female cable connector, IDT connection

Contacts	Wire gauge	Cable outlet	Ordering-No.
4	0,14–0,34 mm <sup>2</sup>	3,5–6 mm	99 0528 14 04
	0,34–0,75 mm <sup>2</sup>	4–8 mm	99 0528 12 04

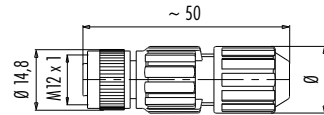

Female cable duo connector, stainless steel locking ring, screw clamp

Contacts	Cable outlet	Ordering-No.
4	2 cables	99 0430 287 04
5	2,1–3 mm/	99 0436 287 05
8	4–5 mm	99 0486 287 08

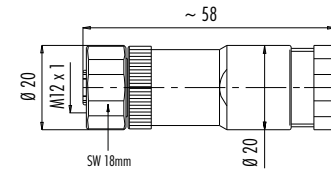

Female cable duo connector, plastic locking system, screw clamp

4	2 cables	99 0430 142 04
5	2,1–3 mm/ 4–5 mm	99 0436 142 05

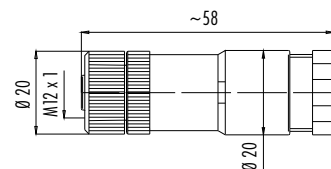

**Rating**

Derating curve according to DIN EN 60512 for **Power-Cable connector**

- 4 contacts
- 5 contacts

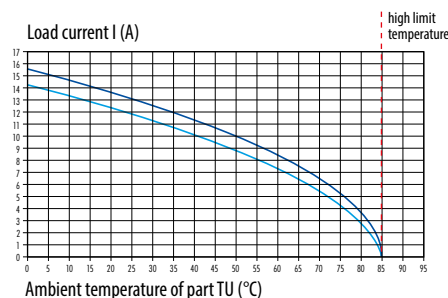

**Description**  
Female cable connector, screw clamp/wire clamp, with shielding ring, shieldable, solder termination on contact 12

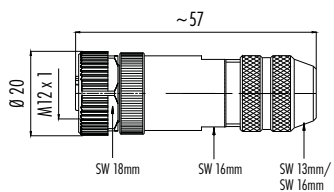

Contacts	Cable outlet	Screw clamp <sup>1)</sup>	Wire clamp
4	4–6 mm	99 1430 814 04	c  US 99 1526 814 04
	6–8 mm	99 1430 812 04	c  US 99 1526 812 04
5	4–6 mm	99 1436 814 05	c  US 99 1538 814 05
	6–8 mm	99 1436 812 05	c  US 99 1538 812 05
8	6–8 mm	99 1486 812 08	c  US –
	8–10 mm	99 1486 914 08	c  US –
12 <sup>1)</sup>	6–8 mm	99 1492 812 12	c  US –

Female cable connector, screw clamp/wire clamp, iris type spring, shieldable

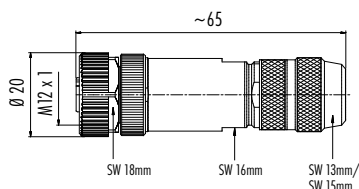

4	5–8 mm	99 1432 814 04	c  US 99 1528 814 04
5	5–8 mm	99 1438 814 05	c  US 99 1540 814 05
8	5–8 mm	99 1488 814 08	c  US –
	8–9 mm	99 1488 812 08	c  US –

Female cable connector, screw clamp, with shielding ring, stainless steel version, shieldable

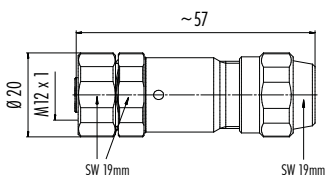

4	3–5,5 mm	99 1430 991 04	
	5,5–8,6 mm	99 1430 992 04	
5	3–5,5 mm	99 1436 991 05	
	5,5–8,6 mm	99 1436 992 05	
8	5,5–8,6 mm	99 1486 992 08	

Female cable connector, crimp, shieldable

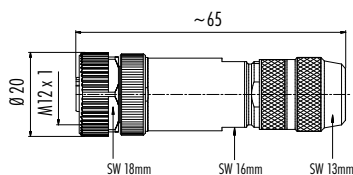

4	5–8 mm	99 1434 814 04	
---	--------	----------------	--

Crimp contacts see page 121/143

Single contact (Female), PU 100 pieces

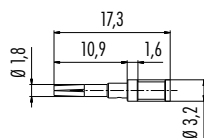

Wire gauge	AWG	Ordering-No.
0,14 mm <sup>2</sup> – 0,34 mm <sup>2</sup>	26–22	61 1227 146
0,34 mm <sup>2</sup> – 0,5 mm <sup>2</sup>	22–20	61 1155 146
0,75 mm <sup>2</sup> – 1,0 mm <sup>2</sup>	18–16	61 1228 146
1,0 mm <sup>2</sup> – 1,5 mm <sup>2</sup>	16	61 1229 146

<sup>1)</sup>Version with solder contacts.

Description	Drawing	Contacts	Cable outlet	Screw clamp <sup>1)</sup>	Wire clamp	
Female angled connector, screw clamp, solder termination on contact 12/wire clamp		3	4–6 mm	99 0430 27 04		–
			6–8 mm	99 0430 161 04		–
			2,5–3,5 mm	99 0430 324 04		–
		4	4–6 mm	99 0430 24 04		99 0524 24 04
			6–8 mm	99 0430 52 04		99 0524 52 04
		5	4–6 mm	99 0436 24 05		99 0536 24 05
12 <sup>1)</sup>	6–8 mm	99 0492 52 12		–		

Female angled connector, stainless steel locking ring, screw clamp		4	4–6 mm	99 0430 92 04	
			6–8 mm	99 0430 292 04	
		5	4–6 mm	99 0436 92 05	
			6–8 mm	99 0436 292 05	

Female angled connector, crimp		4	4–6 mm	99 0530 24 04	
			6–8 mm	99 0530 52 04	

Female angled connector, plastic locking system, screw clamp		4	4–6 mm	99 0430 00 04	
			6–8 mm	99 0430 20 04	transparent housing
		5	6–8 mm	99 0430 69 04	
			6–8 mm	99 0430 68 04	transparent housing
		5	4–6 mm	99 0436 00 05	
			6–8 mm	99 0436 69 05	

Female angled connector, Power		4	8–10 mm	99 0430 58 04	
		5		99 0436 58 05	

It is possible to turn and fix the contact carrier in 4 different 90° positions

Description	Drawing	Contacts	Cable outlet	Screw clamp <sup>1)</sup>	Wire clamp	
Female angled connector, screw clamp/wire clamp, with shielding ring, shieldable, solder termination on contact 12		4	4–6 mm	99 1430 824 04	99 1526 824 04	
			6–8 mm	99 1430 822 04		99 1526 822 04
		5	4–6 mm	99 1436 824 05		99 1538 824 05
			6–8 mm	99 1436 822 05		99 1538 822 05
		12 <sup>1)</sup>	6–8 mm	99 1492 822 12		–

It is possible to turn and fix the contact carrier in 4 different 90° positions

# M12 A-Coding

## Description

Female angled connector, screw clamp/wire clamp, iris type spring, shieldable

## Drawing

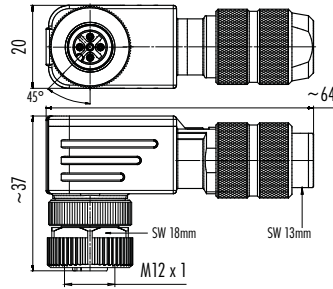

It is possible to turn and fix the contact carrier in 4 different 90° positions

Contacts	Cable outlet	Screw clamp	Wire clamp
4	5-8 mm	99 1432 824 04	99 1528 824 04
5	5-8 mm	99 1438 824 05	99 1540 824 05

Female angled connector, crimp, shieldable

4	5-8 mm	99 1434 824 04
---	--------	----------------



Crimp contacts see page 121/143



### Description

### Drawing

Female cable connector, moulded, PVC (grey), PUR (black)

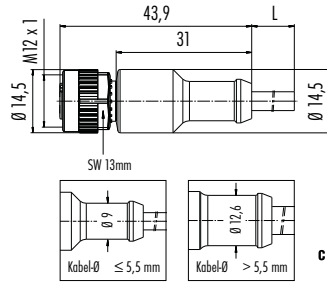

Female cable connector, moulded, shielded, PVC (grey), PUR (black)

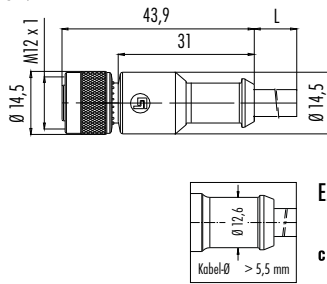

Female cable connector, moulded, 120 °C

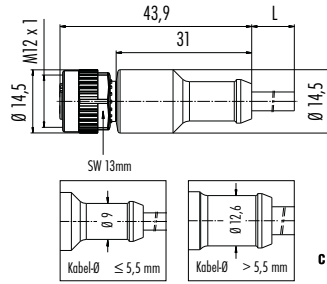

Female cable connector, moulded, PUR, for welding application

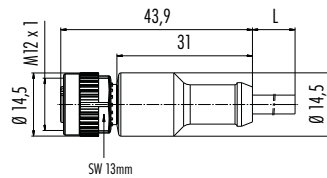

Female cable connector, moulded, PVC (grey), stainless steel locking ring, Food and Beverage

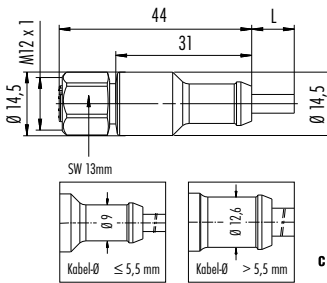

Female cable connector, moulded, PUR, stainless steel locking ring

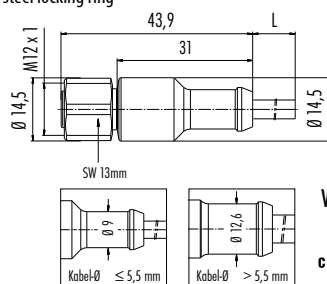

Contacts	Cable length	PVC (cable grey) <sup>1)</sup>	PUR (cable black) <sup>1)</sup>
3 x 0,34	2 m	77 3430 0000 20003-0200	77 3430 0000 50003-0200
	5 m	77 3430 0000 20003-0500	77 3430 0000 50003-0500
4 x 0,34	2 m	77 3430 0000 20004-0200	77 3430 0000 50004-0200
	5 m	77 3430 0000 20004-0500	77 3430 0000 50004-0500
5 x 0,25	2 m	77 3430 0000 20005-0200	77 3430 0000 50005-0200
	5 m	77 3430 0000 20005-0500	77 3430 0000 50005-0500
8 x 0,25 <sup>2)</sup>	2 m	-	77 3430 0000 50608-0200
	5 m	-	77 3430 0000 50608-0500
8 x 0,25	2 m	77 3430 0000 20708-0200	77 3430 0000 50708-0200
	5 m	77 3430 0000 20708-0500	77 3430 0000 50708-0500
12 x 0,25	2 m	77 3430 0000 20712-0200	77 3430 0000 50712-0200
	5 m	77 3430 0000 20712-0500	77 3430 0000 50712-0500
3 x 0,34	2 m	77 3530 0000 20703-0200	77 3530 0000 50703-0200
	5 m	77 3530 0000 20703-0500	77 3530 0000 50703-0500
4 x 0,34	2 m	77 3530 0000 20704-0200	77 3530 0000 50704-0200
	5 m	77 3530 0000 20704-0500	77 3530 0000 50704-0500
5 x 0,25	2 m	77 3530 0000 20705-0200	77 3530 0000 50705-0200
	5 m	77 3530 0000 20705-0500	77 3530 0000 50705-0500
8 x 0,25	2 m	77 3530 0000 20708-0200	77 3530 0000 50708-0200
	5 m	77 3530 0000 20708-0500	77 3530 0000 50708-0500

Contacts	Cable length	PUR (cable black) <sup>1)</sup>
3 x 0,34	2 m	77 3430 0000 70003-0200
	5 m	77 3430 0000 70003-0500
4 x 0,34	2 m	77 3430 0000 70004-0200
	5 m	77 3430 0000 70004-0500

Contacts	Cable length	PUR (cable orange) <sup>1)</sup>	PUR (cable black) <sup>1)</sup>
3 x 0,34	2 m	77 3430 0000 80003-0200	77 3430 0000 80203-0200
	5 m	77 3430 0000 80003-0500	77 3430 0000 80203-0500
4 x 0,34	2 m	77 3430 0000 80004-0200	77 3430 0000 80204-0200
	5 m	77 3430 0000 80004-0500	77 3430 0000 80204-0500
5 x 0,25	2 m	77 3430 0000 80005-0200	77 3430 0000 80205-0200
	5 m	77 3430 0000 80005-0500	77 3430 0000 80205-0500

Contacts	Cable length	PVC (cable grey) <sup>1)</sup>
3 x 0,34	2 m	77 3730 0000 20403-0200
	5 m	77 3730 0000 20403-0500
4 x 0,34	2 m	77 3730 0000 20404-0200
	5 m	77 3730 0000 20404-0500
5 x 0,34	2 m	77 3730 0000 20405-0200
	5 m	77 3730 0000 20405-0500
8 x 0,25	2 m	77 3730 0000 20908-0200
	5 m	77 3730 0000 20908-0500
12 x 0,25	2 m	77 3730 0000 20912-0200
	5 m	77 3730 0000 20912-0500

Contacts	Cable length	PUR (cable black) <sup>1)</sup>
3 x 0,34	2 m	77 3730 0000 50003-0200
	5 m	77 3730 0000 50003-0500
4 x 0,34	2 m	77 3730 0000 50004-0200
	5 m	77 3730 0000 50004-0500
5 x 0,25	2 m	77 3730 0000 50005-0200
	5 m	77 3730 0000 50005-0500
8 x 0,25	2 m	77 3730 0000 50708-0200
	5 m	77 3730 0000 50708-0500

Description	Drawing	Contacts	Cable length	PVC (cable grey) <sup>1)</sup>	PUR (cable black) <sup>1)</sup>
Female cable connector, moulded, PVC (grey), PUR (black), with LED, PNP		3 x 0,34	2 m	77 3630 0000 20003-0200	77 3630 0000 50003-0200
			5 m	77 3630 0000 20003-0500	77 3630 0000 50003-0500
		4 x 0,34	2 m	77 3630 0000 20004-0200	77 3630 0000 50004-0200
			5 m	77 3630 0000 20004-0500	77 3630 0000 50004-0500



Description	Drawing	Contacts	Cable length	PUR (cable black) <sup>1)</sup>
Female cable connector, moulded, PUR (black), Power		4 x 1,5	2 m	77 0606 0000 50704-0200
			5 m	77 0606 0000 50704-0500

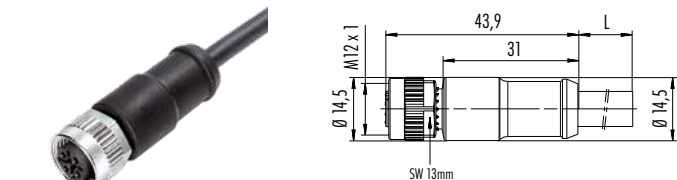

Description	Drawing	Contacts	Cable length	Ordering-No. <sup>1)</sup>
Female cable connector, CAN-Bus		5	2 m	77 2530 0000 50705-0200
			5 m	77 2530 0000 50705-0500
			10 m	77 2530 0000 50705-1000

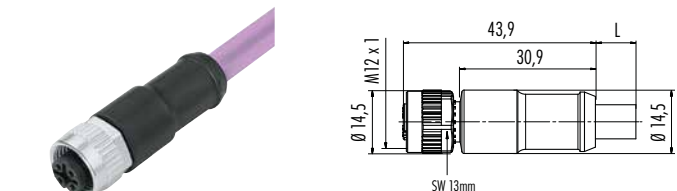

Female terminating connector, CAN-Bus		5	-	77 9840 0000 00005
---------------------------------------	--	---	---	--------------------

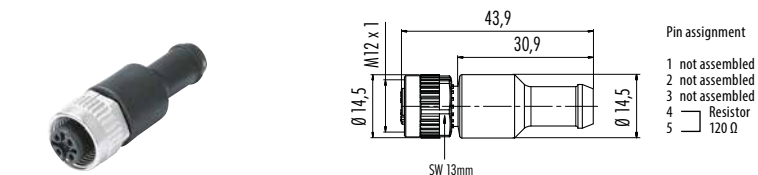

<sup>1)</sup> Standard cable length is 2 m/5 m. Other lengths upon request.

Specifications	Standard Cable									
Contacts	3		4		5		8		12	
Wire gauge	3 x 0,34 mm <sup>2</sup> (AWG 22)		4 x 0,34 mm <sup>2</sup> (AWG 22)		5 x 0,34 mm <sup>2</sup> (AWG 24)		8 x 0,25 mm <sup>2</sup> (AWG 24)		12 x 0,25 mm <sup>2</sup> (AWG 24)	
Material jacket	PVC	PUR	PVC	PUR	PVC	PUR	PVC	PUR	PVC	PUR
Insulation of wire	PVC	PP	PVC	PP	PVC	PP	PVC	PP	PVC	PP
Design of wire (mm)	42 x 0,1					32 x 0,1				
Cable diameter (mm)	4,5	4,3	4,8	4,7	4,8	4,7	6		6,6	6,5
Temperature range cable in move	PVC: - 5 °C /+ 105 °C PUR: - 25 °C /+ 90 °C (in chain flex application + 60 °C)									
Temperature range cable fixed	PVC: - 40 °C /+ 105 °C PUR: - 50 °C /+ 90 °C									
Bending radius (at 10 x D)	2 Mio.	5 Mio.	2 Mio.	5 Mio.	2 Mio.	5 Mio.	2 Mio.			
Approval	UL/CSA									
UL-style	PVC: AWM 2517 PUR: AWM 20549									
Chain flex application	bending radius min. 10 x D, permitted acceleration 5 m/s <sup>2</sup>									

Specifications	Shielded cable							
Contacts	3		4		5		8	
Wire gauge	3 x 0,34 mm <sup>2</sup> (AWG 22)		4 x 0,34 mm <sup>2</sup> (AWG 22)		5 x 0,25 mm <sup>2</sup> (AWG 24)		8 x 0,25 mm <sup>2</sup> (AWG 24)	
Material jacket	PVC	PUR	PVC	PUR	PVC	PUR	PVC	PUR
Insulation of wire	PVC	PP	PVC	PP	PVC	PP	PVC	PP
Design of wire (mm)	42 x 0,1				32 x 0,1			
Cable diameter (mm)	5	4,6	5,4	4,7	5,7	4,8	6,8	6
Temperature range cable in move	PVC: - 5 °C /+ 105 °C PUR: - 25 °C /+ 90 °C (in chain flex application + 60 °C)							
Temperature range cable fixed	PVC: - 20 °C /+ 105 °C PUR: - 50 °C /+80 °C				PVC: - 40 °C /+ 105 °C PUR: - 50 °C /+80 °C			
Bending radius (at 10 x D)	2 Mio.							
Approval	UL/CSA							
Cover screen grid	85 %							
Chain flex application	bending radius min. 10 x D, permitted acceleration 5 m/s <sup>2</sup>							

Specifications	CAN-Bus Cable
Contacts	5
Wire gauge	1 x 2 x AWG 22 and 1 x 2 x AWG 24
Material jacket	PUR
Insulation of wire	Polyolefine
Design of wire (mm)	19 x 0,16/19 x 0,13
Cable diameter (mm)	7,2
UL-style	AWM 1581, AWM 444



# M12 A-Coding

**Description**

**Drawing**

**Contacts**

**Cable length**

**PVC (cable grey)<sup>1)</sup>**

**PUR (cable black)<sup>1)</sup>**

Female angled connector, moulded, PVC (grey), PUR (black)

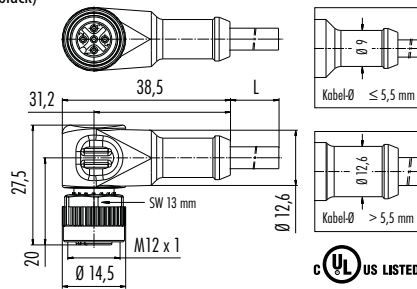

3 x 0,34	2 m	77 3434 0000 20003-0200	77 3434 0000 50003-0200
	5 m	77 3434 0000 20003-0500	77 3434 0000 50003-0500
4 x 0,34	2 m	77 3434 0000 20004-0200	77 3434 0000 50004-0200
	5 m	77 3434 0000 20004-0500	77 3434 0000 50004-0500
5 x 0,25	2 m	77 3434 0000 20005-0200	77 3434 0000 50005-0200
	5 m	77 3434 0000 20005-0500	77 3434 0000 50005-0500
8 x 0,25 <sup>2)</sup>	2 m	-	77 3434 0000 50608-0200
	5 m	-	77 3434 0000 50608-0500
8 x 0,25	2 m	77 3434 0000 20708-0200	77 3434 0000 50708-0200
	5 m	77 3434 0000 20708-0500	77 3434 0000 50708-0500
12 x 0,25	2 m	77 3434 0000 20712-0200	77 3434 0000 50712-0200
	5 m	77 3434 0000 20712-0500	77 3434 0000 50712-0500

Female angled connector, moulded, shielded, PVC (grey), PUR (black)

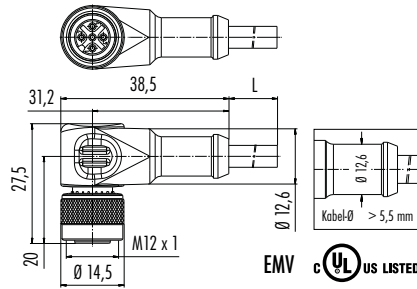

3 x 0,34	2 m	77 3534 0000 20703-0200	77 3534 0000 50703-0200
	5 m	77 3534 0000 20703-0500	77 3534 0000 50703-0500
4 x 0,34	2 m	77 3534 0000 20704-0200	77 3534 0000 50704-0200
	5 m	77 3534 0000 20704-0500	77 3534 0000 50704-0500
5 x 0,25	2 m	77 3534 0000 20705-0200	77 3534 0000 50705-0200
	5 m	77 3534 0000 20705-0500	77 3534 0000 50705-0500
8 x 0,25	2 m	77 3534 0000 20708-0200	77 3534 0000 50708-0200
	5 m	77 3534 0000 20708-0500	77 3534 0000 50708-0500

Female angled connector, moulded, 120 °C

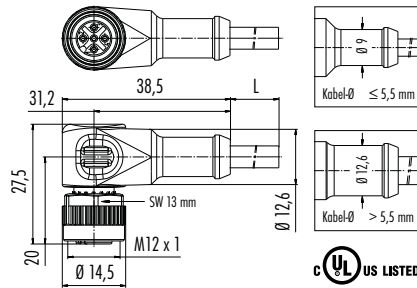

3 x 0,34	2 m	77 3434 0000 70003-0200	
	5 m	77 3434 0000 70003-0500	
4 x 0,34	2 m	77 3434 0000 70004-0200	
	5 m	77 3434 0000 70004-0500	

Female angled connector, moulded, PUR, for welding application

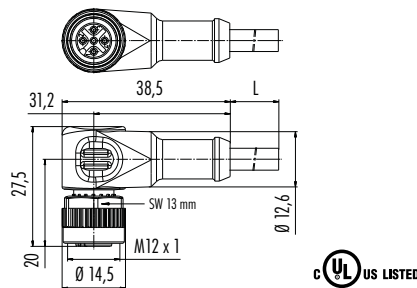

3 x 0,34	2 m	77 3434 0000 80003-0200	77 3434 0000 80203-0200
	5 m	77 3434 0000 80003-0500	77 3434 0000 80203-0500
4 x 0,34	2 m	77 3434 0000 80004-0200	77 3434 0000 80204-0200
	5 m	77 3434 0000 80004-0500	77 3434 0000 80204-0500
5 x 0,25	2 m	77 3434 0000 80005-0200	77 3434 0000 80205-0200
	5 m	77 3434 0000 80005-0500	77 3434 0000 80205-0500

Female angled connector, moulded, PVC (grey), stainless steel locking ring, Food and Beverage

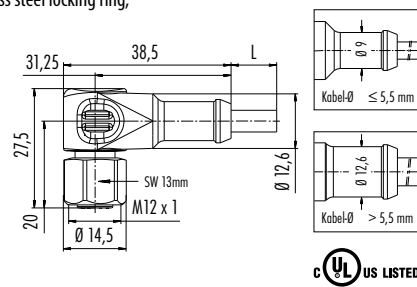

3 x 0,34	2 m	77 3734 0000 20403-0200	
	5 m	77 3734 0000 20403-0500	
4 x 0,34	2 m	77 3734 0000 20404-0200	
	5 m	77 3734 0000 20404-0500	
5 x 0,34	2 m	77 3734 0000 20405-0200	
	5 m	77 3734 0000 20405-0500	
8 x 0,25	2 m	77 3734 0000 20908-0200	
	5 m	77 3734 0000 20908-0500	
12 x 0,25	2 m	77 3734 0000 20912-0200	
	5 m	77 3734 0000 20912-0500	

Female angled connector, moulded, PUR, stainless steel locking ring

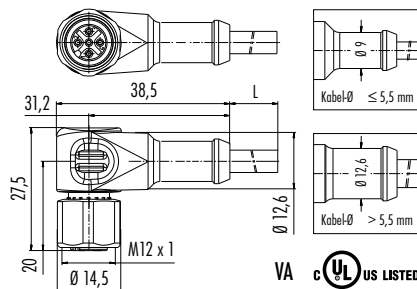

3 x 0,34	2 m	77 3734 0000 50003-0200	
	5 m	77 3734 0000 50003-0500	
4 x 0,34	2 m	77 3734 0000 50004-0200	
	5 m	77 3734 0000 50004-0500	
5 x 0,25	2 m	77 3734 0000 50005-0200	
	5 m	77 3734 0000 50005-0500	
8 x 0,25	2 m	77 3734 0000 50708-0200	
	5 m	77 3734 0000 50708-0500	

<sup>1)</sup>Standard cable length is 2 m/5 m. Other lengths upon request. <sup>2)</sup>Shielded cable, shield on contact 8.

## Description

Female angled connector, moulded, PUR, stainless steel locking ring, with LED, PNP



## Drawing

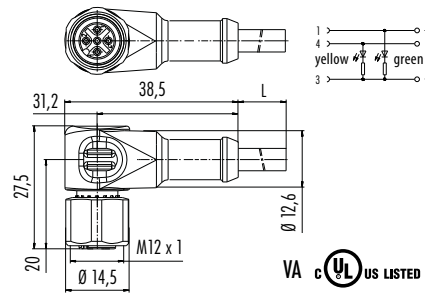

Contacts	Cable length	PUR (cable black) <sup>1)</sup>
3 x 0,34	2 m LED, PNP	77 3834 0000 50003-0200
	5 m LED, PNP	77 3834 0000 50003-0500

Female angled connector, moulded, PVC (grey), PUR (black), with LED, PNP

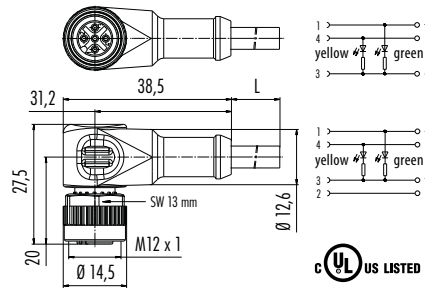

Contacts	Cable length	PVC (cable grey) <sup>1)</sup>	PUR (cable black) <sup>1)</sup>
3 x 0,34	2 m	77 3634 0000 20003-0200	77 3634 0000 50003-0200
	5 m	77 3634 0000 20003-0500	77 3634 0000 50003-0500
4 x 0,34	2 m	77 3634 0000 20004-0200	77 3634 0000 50004-0200
	5 m	77 3634 0000 20004-0500	77 3634 0000 50004-0500

**Description**

Male panel mount connector, fixing thread, solder

**Drawing**

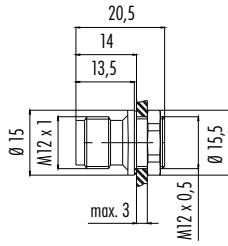

**Contacts**

**Fixing thread**

**Ordering-No.**

4		09 0431 81 04
5	M12 x 0,5	09 0433 81 05
8		09 0381 81 08



Male panel mount connector, fixing thread, solder

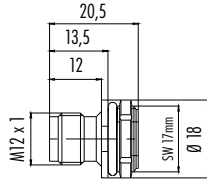

4	PG 9	86 4231 1002 00004
	M16 x 1,5	86 4331 1002 00004
5	PG 9	86 4231 1002 00005
	M16 x 1,5	86 4331 1002 00005
8	PG 9	86 4231 1002 00008
	M16 x 1,5	86 4331 1002 00008



Male panel mount connector, fixing thread, solder

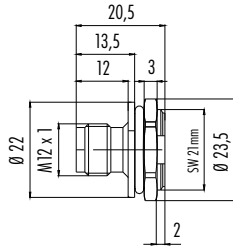

4	PG 11	09 0435 87 04
5		09 0437 87 05



Male panel mount connector, fixing thread, solder

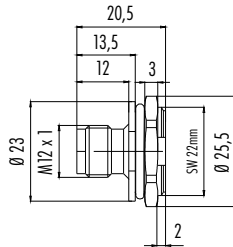

4	PG 13,5	86 4531 1002 00004
	M20 x 1,5	86 4631 1002 00004
5	PG 13,5	86 4531 1002 00005
	M20 x 1,5	86 4631 1002 00005



Male panel mount connector, metric fixing thread, positioning possible, solder

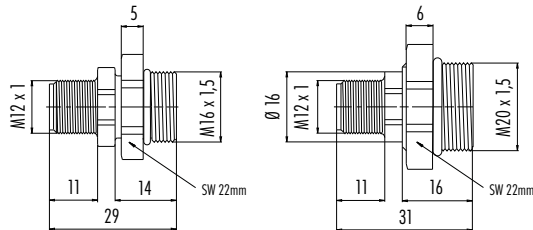

4	M16 x 1,5	09 0431 397 04
	M20 x 1,5	09 0439 397 04



**Specifications**

**Panel mount connector**

Contacts	4	5	8	12
Wire gauge	max. 0,25 mm <sup>2</sup> (max. AWG 24), single wires AWG 24 (0,25 mm <sup>2</sup> ), Power: max. 1,5 mm <sup>2</sup> (max. AWG 16), single wires AWG 18			AWG 26 (0,14 mm <sup>2</sup> )
Mechanical operation	> 100 Mating cycles			
Temperature range	- 40 °C / + 85 °C			
Rated voltage	250 V	60 V (125 V UL)	30 V (60 V UL)	30 V
Pollution degree	3			
Rated current (40°C)	4 A (3 A UL), Power 8 A	4 A (3 A UL), Power cont. 1-4 8 A, cont. 5 2 A	1,5 A (2 A UL)	
Contact plating	Au (Gold)			
Material of housing	PA, zinc diecasting nickel plated			

Description	Drawing	Contacts	Ordering-No. <sup>1)</sup>
Male panel mount connector with single wires, AWG 24, M16 x 1,5, plastic housing		4	76 4331 0011 00004-0200
		5	76 4331 0011 00005-0200
		8	76 4331 0011 00008-0200
		12	76 4331 0111 00012-0200



Male panel mount connector with single wires, AWG 24, M20 x 1,5, plastic housing		4	76 4631 0011 00004-0200
		5	76 4631 0011 00005-0200
		8	76 4631 0011 00008-0200
		12	76 4631 0111 00012-0200



Male panel mount connector, front fastened, with single wires, AWG 24, M16 x 1,5, plastic housing		4	76 4731 3011 00004-0200
		5	76 4731 3011 00005-0200
		8	76 4731 3011 00008-0200
		12	76 4731 3111 00012-0200



Description	Drawing	Contacts	Fixing thread	Contact insert	Ordering-No. <sup>1)</sup>
Male panel mount connector with single wires, AWG 24, metal housing		4	M16 x 1,5 (AWG24)	black	76 0231 0011 00004-0200
				purple	76 0231 0011 00104-0200
				orange	76 0231 0011 00204-0200
				yellow	76 0231 0011 00304-0200
				green	76 0231 0011 00404-0200
				red	76 0231 0011 00504-0200
				blue	76 0231 0011 00604-0200
				black	76 0231 0011 00005-0200
		5	M16 x 1,5 (AWG24)	purple	76 0231 0011 00105-0200
				orange	76 0231 0011 00205-0200
				yellow	76 0231 0011 00305-0200
				green	76 0231 0011 00405-0200
				red	76 0231 0011 00505-0200
				blue	76 0231 0011 00605-0200
				PG 9	76 0131 0011 00004-0200
				PG 9 Stainless steel	76 2131 0111 00004-0200
PG 9 Power	09 3431 433 04				
4	M16 x 1,5 Stainless steel	black	76 2231 0111 00004-0200		
		PG 9	76 0131 0011 00005-0200		
		PG 9 Stainless steel	76 2131 0111 00005-0200		
		PG 9 Power	09 3441 433 05		
		PG 9	76 2231 0111 00005-0200		
		PG 9	76 0131 0011 00008-0200		
		PG 9 Stainless steel	76 2131 0111 00008-0200		
		PG 9 Power	76 2231 0111 00008-0200		
5	M16 x 1,5	black	76 0231 0011 00008-0200		
		PG 9	76 2131 0111 00008-0200		
		PG 9 Stainless steel	76 2231 0111 00008-0200		
		PG 9	76 0131 0111 00012-0200		
8	M16 x 1,5	black	76 0231 0111 00012-0200		
		PG 9	76 0231 0111 00012-0200		
12	M16 x 1,5	black	76 0231 0111 00012-0200		
		PG 9	76 0231 0111 00012-0200		

Male panel mount connector with single wires/Power with single wires, metal housing		4	M16 x 1,5	black	76 0231 0011 00004-0200
					76 0231 0111 00004-0200
Male panel mount connector with single wires, AWG 16, Power		4	M16 x 1,5	black	76 0231 0015 00004-0200
					76 0231 0115 00004-0200

Male panel mount connector with single wires, AWG 16, Power		4	M16 x 1,5	black	76 0231 0015 00004-0200
					76 0231 0115 00004-0200



# M12 A-Coding

**Description**

Male panel mount connector with single wires, AWG 24, metal housing

**Drawing**

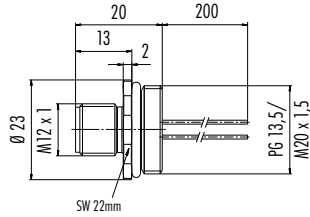

Contacts	Fixing thread	Ordering-No. <sup>1)</sup>
4	PG 13,5	76 0331 0111 00004-0200
	M20 x 1,5	76 0431 0111 00004-0200
5	PG 13,5	76 0331 0111 00005-0200
	M20 x 1,5	76 0431 0111 00005-0200
8	PG 13,5	76 0331 0111 00008-0200
	M20 x 1,5	76 0431 0111 00008-0200
12	PG 13,5	76 0331 0111 00012-0200
	M20 x 1,5	76 0431 0111 00012-0200

Male panel mount connector, solder, metal housing

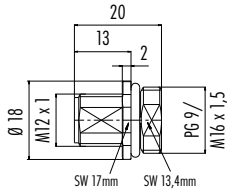

4	PG 9	86 0131 0002 00004
	M16 x 1,5	86 0231 0002 00004
5	PG 9	86 0131 0002 00005
	M16 x 1,5	86 0231 0002 00005
8	PG 9	86 0131 0002 00008
	M16 x 1,5	86 0231 0002 00008

Male panel mount connector with single wires, Outdoor, IP68, IP69K

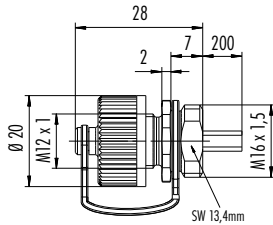

4	M16 x 1,5	09 3431 284 04
---	-----------	----------------

Male panel mount connector, screw clamp termination/Power, screw clamp termination

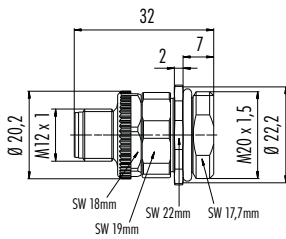

4 Power		99 0431 500 04	
5 Power	M20 x 1,5	99 0433 500 05	
8		86 0431 0003 00008	

Male panel mount connector, positioning possible, with single wires, metal housing

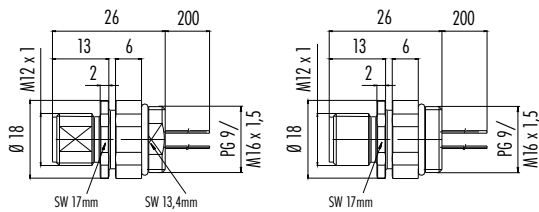

Stainless steel version



4	PG 9	76 0731 0011 00004-0200
	M16 x 1,5	76 0831 0011 00004-0200
	PG 9 Stainless steel	76 2731 0111 00004-0200
	M16 x 1,5 Stainless steel	76 2831 0111 00004-0200
5	PG 9	76 0731 0011 00005-0200
	M16 x 1,5	76 0831 0011 00005-0200
	PG 9 Stainless steel	76 2731 0111 00005-0200
	M16 x 1,5 Stainless steel	76 2831 0111 00005-0200
8	PG 9	76 0731 0011 00008-0200
	M16 x 1,5	76 0831 0011 00008-0200
	PG 9 Stainless steel	76 2731 0111 00008-0200
	M16 x 1,5 Stainless steel	76 2831 0111 00008-0200
12	PG 9	76 0731 0011 00012-0200
	M16 x 1,5	76 0831 0111 00012-0200

Male panel mount connector, front fastened, with single wires, metal housing

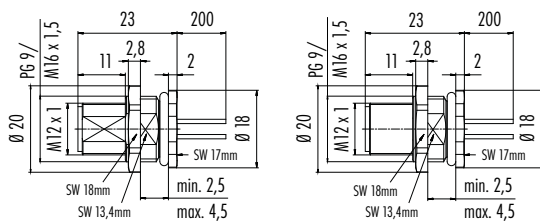

Stainless steel version



4	PG 9	76 0531 1011 00004-0200
	M16 x 1,5 (AWG 24)	76 0631 1011 00004-0200
5	PG 9	76 0531 1011 00005-0200
	M16 x 1,5 (AWG 24)	76 0631 1011 00005-0200
8	PG 9	76 0531 1011 00008-0200
	M16 x 1,5 (AWG 24)	76 0631 1011 00008-0200
12	PG 9	76 0531 1111 00012-0200
	M16 x 1,5 (AWG 24)	76 0631 1111 00012-0200

<sup>1)</sup> Standard wire length is 200 mm for 76-order-numbers. Other lengths upon request.

Description	Drawing	Contacts	Fixing thread	Ordering-No.
Male panel mount connector, front fastened, with single wires, AWG 16, Power		4	M16 x 1,5	76 0631 1015 00004-0200

Male panel mount connector, rectangular flange, with single wires, metal housing, IP40 without sealing, IP67 with sealing (16 0959 000)		4	–	76 0931 0111 00004-0200
		5	–	76 0931 0111 00005-0200
		8	–	76 0931 0111 00008-0200
		12	–	76 0931 0111 00012-0200

Male panel mount connector, front fastened, solder, metal housing		4	PG 9	86 0531 1002 00004
			M16 x 1,5	86 0631 1002 00004
		5	PG 9	86 0531 1002 00005
			M16 x 1,5	86 0631 1002 00005
	8	PG 9	86 0531 1002 00008	
		M16 x 1,5	86 0631 1002 00008	

Male panel mount connector, dip-solder, metal housing		4	PG 9	86 0131 0000 00004
			M16 x 1,5	86 0231 0000 00004
		5	PG 9	86 0131 0000 00005
			M16 x 1,5	86 0231 0000 00005
		8	PG 9	86 0131 0000 00008
			M16 x 1,5	86 0231 0000 00008
	12	PG 9	86 0131 0100 00012	
		M16 x 1,5	86 0231 0100 00012	

Male panel mount connector, front fastened, dip-solder, metal housing		4	PG 9	86 0531 1000 00004	
			M16 x 1,5	86 0631 1000 00004	
			PG 9	86 0531 1000 00005	
		5	M16 x 1,5	86 0631 1000 00005	
			PG 9	Stainless steel	86 2531 1100 00005
			PG 9	86 0531 1000 00008	
		8	M16 x 1,5	86 0631 1000 00008	
			PG 9	Stainless steel	86 2531 1100 00008
			PG 9	86 0531 1100 00012	
			M16 x 1,5	86 0631 1100 00012	

Male panel mount connector, front fastened, dip-solder, with shielding sheet		4		86 0531 1120 00004
		5	PG 9	86 0531 1120 00005
		8		86 0531 1120 00008
		12		86 0531 1120 00012

Description	Drawing	Contacts	Fixing thread	Ordering-No.
Male angled panel mount connector, front fastened, dip-solder, with shielding sheet		4 5	PG 9	86 0531 1121 00004 86 0531 1121 00005



Male panel mount connector, front fastened, dip-solder, metal housing		4 5 8 12	M12 x 1	86 1031 1100 00004 86 1031 1100 00005 86 1031 1100 00008 86 1031 1100 00012
---	--	-------------------	---------	--



Description	Drawing	Contacts	Ordering-No.
Male receptacle for PCB assembly		4 5 8	99 3431 200 04 99 3431 458 04 with shielding sheet 99 3441 200 05 99 3441 458 05 with shielding sheet 99 3481 200 08 99 3481 458 08 with shielding sheet



Description	Drawing	Contacts	Ordering-No.
Male angled receptacle, for PCB assembly		4 5 8	99 3431 202 04 99 3431 601 04 with shielding sheet 99 3441 202 05 99 3441 601 05 with shielding sheet 99 3481 202 08 99 3481 601 08 with shielding sheet



Description	Drawing	Contacts	Mounting height	not shieldable	shieldable
Male receptacle, SMT, with housing, not shieldable/shieldable		4 5 8	9 mm	99 3431 351 04 99 3441 351 05 99 3481 351 08	99 3431 401 04 99 3441 401 05 99 3481 401 08

Male receptacle, SMT, not shieldable/shieldable		4 5 8		09 0431 600 04 09 0433 600 05 09 0381 600 08	09 0431 601 04 09 0433 601 05 09 0381 601 08
---	--	-------------	--	--	--

## Description

Male panel mount connector M16, with shielded PUR-cable

## Drawing

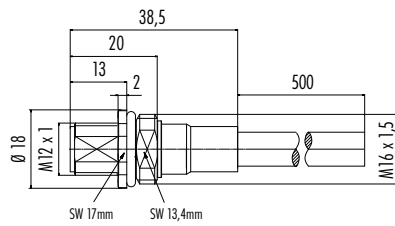

Contacts	Cable length, PUR	Fixing thread	Ordering-No.
5	0,5 m	M16 x 1,5	70 3441 785 05
8			70 3481 785 08

Male panel mount connector PG 9, front fastened, with shielded PUR-cable

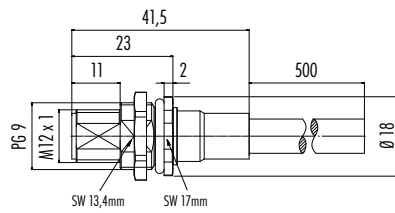

Hexagonal nut enclosed loose

5	0,5 m	PG 9	70 3441 287 05
8			70 3481 287 08



## Description

Female panel mount connector, solder, plastic housing



## Drawing

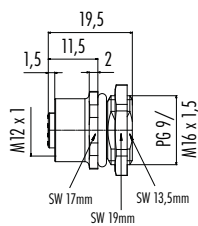

Hexagonal nut enclosed loose



Contacts	Fixing thread	Ordering-No.
4	PG 9	86 4232 1002 00004
	M16 x 1,5	86 4332 1002 00004
5	PG 9	86 4232 1002 00005
	M16 x 1,5	86 4332 1002 00005
8	PG 9	86 4232 1002 00008
	M16 x 1,5	86 4332 1002 00008

Female panel mount connector, front fastened, solder, plastic housing

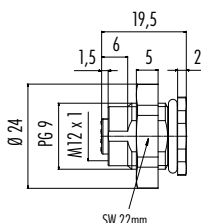

Hexagonal nut enclosed loose



4		86 4832 3002 00004
5	PG 9	86 4832 3002 00005
8		86 4832 3002 00008

Female panel mount connector, front fastened, dip-solder, plastic housing

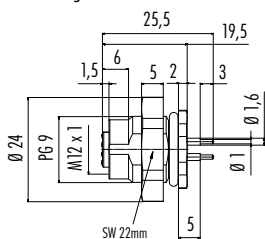

Hexagonal nut enclosed loose

4		86 4832 3000 00004
5	PG 9	86 4832 3000 00005
8		86 4832 3000 00008

Female panel mount connector with single wires, AWG 24, M16 x 1,5, plastic housing

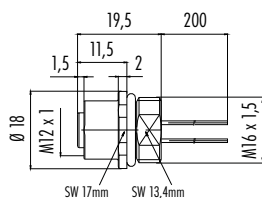

Contacts	Ordering-No. <sup>1)</sup>
4	76 4332 0011 00004-0200
5	76 4332 0011 00005-0200
8	76 4332 0011 00008-0200
12	76 4332 0111 00012-0200

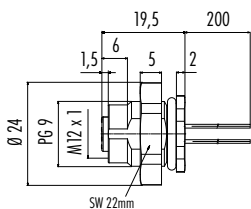

Female panel mount connector, front fastened, with single wires, AWG 24, PG 9, plastic housing



4	76 4832 3011 00004-0200
5	76 4832 3011 00005-0200
8	76 4832 3011 00008-0200
12	76 4832 3111 00012-0200

<sup>1)</sup> Standard wire length is 200 mm for 76-order-numbers. Other lengths upon request.

Description	Drawing	Contacts	Fixing thread	Contact insert	Ordering-No. <sup>1)</sup>
Female panel mount connector with single wires, AWG 24, metal housing		4	M16 x 1,5 (AWG24)	black	76 0232 0011 00004-0200
				purple	76 0232 0011 00104-0200
				orange	76 0232 0011 00204-0200
				yellow	76 0232 0011 00304-0200
				green	76 0232 0011 00404-0200
				red	76 0232 0011 00504-0200
				blue	76 0232 0011 00604-0200
				black	76 0232 0011 00005-0200
				purple	76 0232 0011 00105-0200
				orange	76 0232 0011 00205-0200
yellow	76 0232 0011 00305-0200				
green	76 0232 0011 00405-0200				
red	76 0232 0011 00505-0200				
blue	76 0232 0011 00605-0200				

Description	Drawing	Contacts	Fixing thread	Contact insert	Ordering-No. <sup>1)</sup>
Female panel mount connector with single wires/Power with single wires, metal housing		4	M16 x 1,5 (AWG24)	PG 9	76 0132 0011 00004-0200
				PG 9 Stainless steel	76 2132 0111 00004-0200
				PG 9 Power	09 3432 433 04 
				M16 x 1,5 Stainless steel	76 2232 0111 00004-0200
				PG 9	76 0132 0011 00005-0200
				PG 9 Stainless steel	76 2132 0111 00005-0200
				PG 9 Power	09 3442 433 05 
				M16 x 1,5 Stainless steel	76 2232 0111 00005-0200
				PG 9	76 0132 0011 00008-0200
				M16 x 1,5	76 0232 0011 00008-0200
PG 9 Stainless steel	76 2132 0111 00008-0200				
M16 x 1,5 Stainless steel	76 2232 0111 00008-0200				
PG 9	76 0132 0011 00012-0200				
M16 x 1,5	76 0232 0011 00012-0200				

Female panel mount connector with single wires, AWG 16, Power		4	M16 x 1,5	black	76 0232 0015 00004-0200
---	--	---	-----------	-------	-------------------------

Description	Drawing	Contacts	Fixing thread	Contact insert	Ordering-No. <sup>1)</sup>
Female panel mount connector with single wires, AWG 24, metal housing		4	M20 x 1,5	black	76 0432 0111 00004-0200
					76 0432 0111 00005-0200
					76 0432 0111 00008-0200
					76 0432 0111 00012-0200

Description	Drawing	Contacts	Fixing thread	Contact insert	Ordering-No. <sup>1)</sup>
Female panel mount connector with single wires, AWG 24, metal housing		4	M20 x 1,5	black	76 0432 0111 00004-0200
					76 0432 0111 00005-0200
					76 0432 0111 00008-0200
					76 0432 0111 00012-0200

Description	Drawing	Contacts	Fixing thread	Contact insert	Ordering-No. <sup>1)</sup>
Female panel mount connector, solder, metal housing		4	M16 x 1,5	black	86 0132 0002 00004
					86 0232 0002 00004
					86 0132 0002 00005
					86 0232 0002 00005
4	M16 x 1,5	black	86 0132 0002 00008		
			86 0232 0002 00008		

Description	Drawing	Contacts	Fixing thread	Contact insert	Ordering-No. <sup>1)</sup>
Female panel mount connector with single wires, Outdoor, IP68, IP69K		4	M16 x 1,5	black	09 3432 284 04

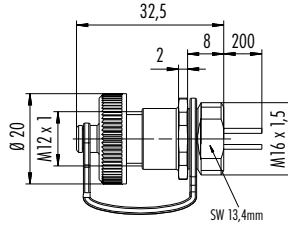
Description	Drawing	Contacts	Fixing thread	Contact insert	Ordering-No. <sup>1)</sup>
Female panel mount connector with single wires, Outdoor, IP68, IP69K		4	M16 x 1,5	black	09 3432 284 04

### Description

### Drawing

### Contacts

### Fixing thread

### Ordering-No.

Female panel mount connector, screw clamp termination/Power, screw clamp termination

4 Power		99 0432 500 04	
5 Power	M20 x 1,5	99 0434 500 05	
8		86 0432 0003 00008	

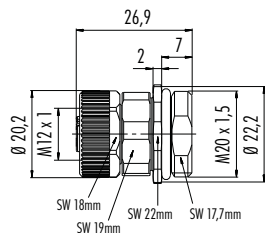

Female panel mount connector, positioning possible, with single wires, metal housing

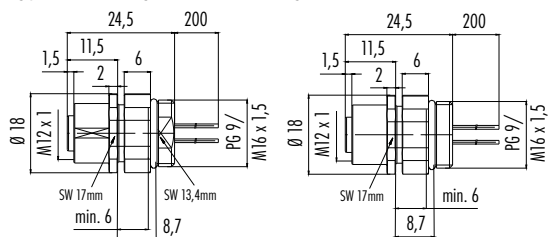

Stainless steel version

4	PG 9		76 0732 0011 00004-0200
	M16 x 1,5		76 0832 0011 00004-0200
	PG 9	Stainless steel	76 2732 0111 00004-0200
5	M16 x 1,5	Stainless steel	76 2832 0111 00004-0200
	PG 9		76 0732 0011 00005-0200
	M16 x 1,5		76 0832 0011 00005-0200
8	PG 9	Stainless steel	76 2732 0111 00005-0200
	M16 x 1,5	Stainless steel	76 2832 0111 00005-0200
	PG 9		76 0732 0011 00008-0200
12	M16 x 1,5		76 0832 0011 00008-0200
	PG 9	Stainless steel	76 2732 0111 00008-0200
	M16 x 1,5	Stainless steel	76 2832 0111 00008-0200

Female panel mount connector, front fastened, with single wires, metal housing

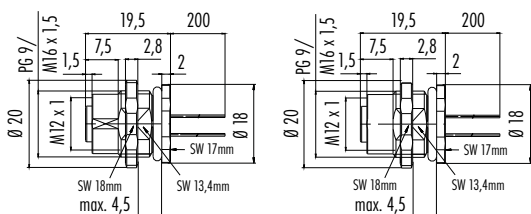

Stainless steel version

4	PG 9		76 0532 1011 00004-0200
	M16 x 1,5	(AWG 24)	76 0632 1011 00004-0200
	PG 9	Stainless steel	76 2532 1111 00004-0200
5	PG 9		76 0532 1011 00005-0200
	M16 x 1,5	(AWG 24)	76 0632 1011 00005-0200
	PG 9	Stainless steel	76 2532 1111 00005-0200
8	PG 9		76 0532 1011 00008-0200
	M16 x 1,5	(AWG 24)	76 0632 1011 00008-0200
	PG 9	Stainless steel	76 2532 1111 00008-0200
12	PG 9		76 0532 1111 00012-0200
	M16 x 1,5	(AWG 24)	76 0632 1111 00012-0200
	PG 9		76 0532 1011 00004-0200

Female panel mount connector, front fastened, with single wires, AWG 16, Power

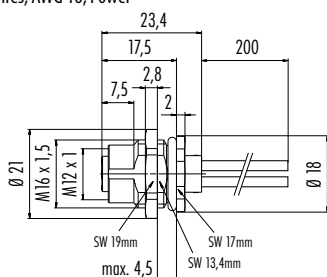

4	M16 x 1,5		76 0632 1015 00004-0200
---	-----------	--	-------------------------

Female panel mount connector, rectangular flange, with single wires, metal housing, IP40 without sealing, IP67 with sealing (16 0959 000)

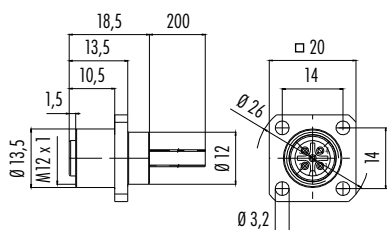

4	-		76 0932 0111 00004-0200
5	-		76 0932 0111 00005-0200
8	-		76 0932 0111 00008-0200
12	-		76 0932 0111 00012-0200

Female panel mount connector, front fastened, solder, unmounted, metal housing

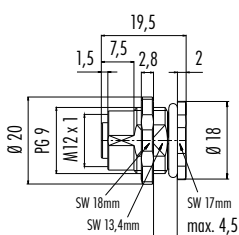

4	PG 9		86 0532 1002 00004
	M16 x 1,5		86 0632 1002 00004
5	PG 9		86 0532 1002 00005
	M16 x 1,5		86 0632 1002 00005
8	PG 9		86 0532 1002 00008
	M16 x 1,5		86 0632 1002 00008

<sup>1)</sup> Standard wire length is 200 mm for 76-order-numbers. Other lengths upon request.

**Description**

Female panel mount connector, dip-solder, metal housing

**Drawing**

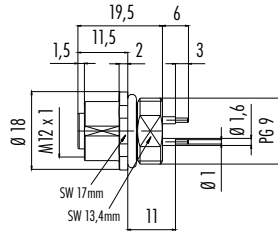

Contacts	Fixing thread	Ordering-No.
4	PG 9	86 0132 0000 00004
	M16 x 1,5	86 0232 0000 00004
5	PG 9	86 0132 0000 00005
	M16 x 1,5	86 0232 0000 00005
8	PG 9	86 0132 0000 00008
	M16 x 1,5	86 0232 0000 00008
12	PG 9	86 0132 0100 00012
	M16 x 1,5	86 0232 0100 00012

Female panel mount connector, front fastened, dip-solder, 6 mm contact length

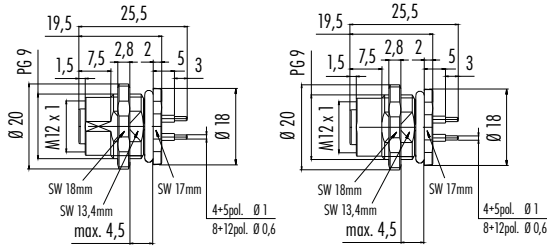

Stainless steel version



4	PG 9	86 0532 1000 00004
	M16 x 1,5	86 0632 1000 00004
5	PG 9	86 0532 1000 00005
	M16 x 1,5	86 0632 1000 00005
8	PG 9 Stainless steel	86 2532 1100 00005
	PG 9	86 0532 1000 00008
12	M16 x 1,5	86 0632 1000 00008
	PG 9 Stainless steel	86 2532 1100 00008
12	PG 9	86 0532 1100 00012
	M16 x 1,5	86 0632 1100 00012

Female panel mount connector, front fastened, dip-solder, 12 mm contact length

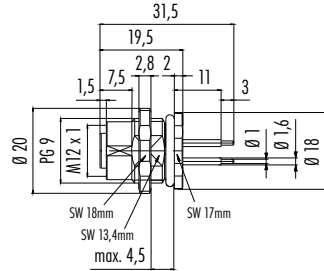

4	PG 9	09 3432 92 04
5		09 3442 92 05

Female panel mount connector, front fastened, dip-solder, with shielding sheet

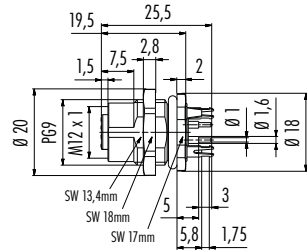

PCB thickness: 1,6 mm



4		86 0532 1120 00004
5	PG 9	86 0532 1120 00005
8		86 0532 1120 00008
12		86 0532 1120 00012

Female angled panel mount connector, front fastened, dip-solder, with shielding sheet

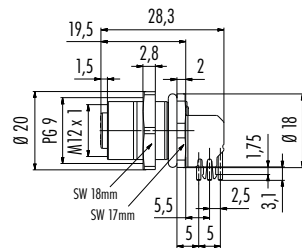

PCB thickness: 1,6 mm



4		86 0532 1121 00004
5	PG 9	86 0532 1121 00005

# M12 A-Coding

## Description

Female receptacle for PCB assembly

## Drawing

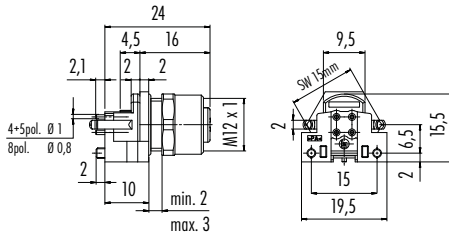

PCB thickness: 1,6 mm

View of mating side



## Contacts Ordering-No.

4	99 3432 200 04	
	99 3432 458 04	with shielding sheet
5	99 3442 200 05	
	99 3442 458 05	with shielding sheet
8	99 3482 200 08	
	99 3482 458 08	with shielding sheet

Female angled receptacle, for PCB assembly

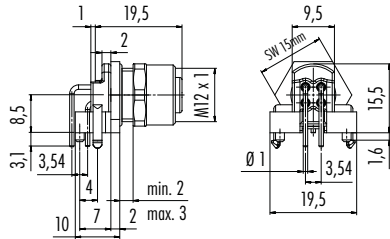

PCB thickness: 1,6 mm

View of mating side



4	99 3432 202 04	
	99 3432 601 04	with shielding sheet
5	99 3442 202 05	
	99 3442 601 05	with shielding sheet
8	99 3482 202 08	
	99 3482 601 08	with shielding sheet

Female receptacle, SMT, with housing, not shieldable/shieldable

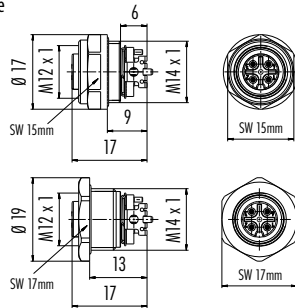

Mounting height 9 mm

Mounting height 13 mm

Contacts	Mounting height	not shieldable	shieldable
4	9 mm	99 3432 351 04	99 3432 401 04
	13 mm	99 3432 352 04	99 3432 402 04
5	9 mm	99 3442 351 05	99 3442 401 05
	13 mm	99 3442 352 05	99 3442 402 05
8	9 mm	99 3482 351 08	99 3482 401 08
	13 mm	99 3482 352 08	99 3482 402 08

Female receptacle, SMT, not shieldable/shieldable

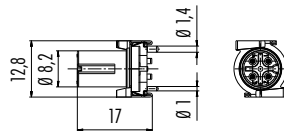

4		09 0432 600 04	09 0432 601 04
5	-	09 0434 600 05	09 0434 601 05
8		09 0484 600 08	09 0484 601 08

Female panel mount connector M16, with shielded PUR-cable

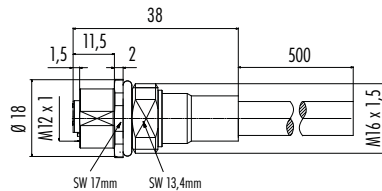

Contacts	Cable length, PUR	Fixing thread	Ordering-No.
5			70 3442 785 05
8	0,5 m	M16 x 1,5	70 3482 785 08

Female panel mount connector PG 9, front fastened, with shielded PUR-cable

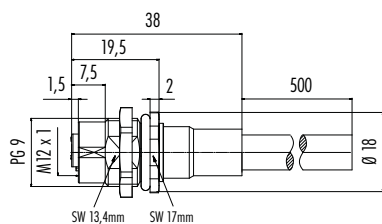

Hexagonal nut enclosed loose

5	0,5 m	PG 9	70 3442 287 05
8			70 3482 287 08

## Panel cut out

### Panel mount connector

With flats as anti-rotation device

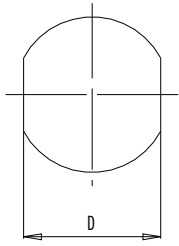

With bore hole

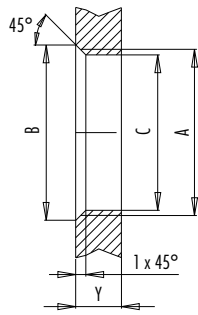

Installation direction:  
o-ring sits on chamfer.

Thread	A	B (mm)	C (mm)	D (mm)
PG 9		16,2	15,3	13,5
PG 11		20,2	18,7	17,0
PG 13,5		21,5	20,5	—
M12 x 0,5		—	12,1	—
M12 x 1		—	12,2	—
M14 x 1		15,2	14,2	—
M16 x 1,5		17,0	16,1	13,5
M20 x 1,5		21,0	20,1	—

#### Tightening moment

Metal housing	6,25 Nm
Positioning sleeve	6,25 Nm
Metal housing, screw clamp connection	5,00 Nm
Plastic housing	1,25 Nm
Positioning sleeve	1,25 Nm

Thickness of wall Y (mm)		
Version	min (mm)	max (mm)
Fastened from back side	2	3,5
Front fastened	2	4,5
Positioning possible <sup>1)</sup>	2	3,5
Screw clamp	2	3,5
Thread M12 x 1	2	3,0
Thread M14 x 1 <sup>2)</sup>	<sup>3)</sup> 1,5/ <sup>4)</sup> 2	6,5

#### Notes

- <sup>1)</sup> Do not attach a chamfer
- <sup>2)</sup> Wall thickness:  
use locknut 01-5385 up to 1,5 mm  
>1,5 mm cut thread
- <sup>3)</sup> Nut
- <sup>4)</sup> Thread in wall of housing

### Panel mount connector, square flange

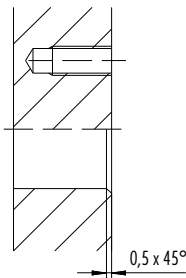
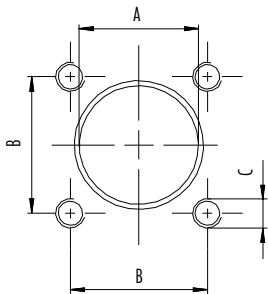

Housing	A	B (mm)	C (mm)	D (mm)
Metal		12,2	14,0	M3 (4x)
Plastic		20,0	20,0	M3 (4x)

#### Requirements for Degree of protection IP67:

1. Metal housing: Use of sealing, Ordering-No. 16 0959 000
2. Plastic housing: Use of sealing, Ordering-No. 16 8091 000
3. M3 thread (4x) sealed as a threaded blind holes or screw heads

**Description**

**Drawing**

**Ordering-No.**

Protection cap for male cable connector, IP67

08 2424 010 000

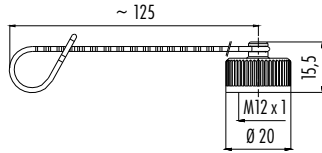

Protection cap for female cable connector, IP67

08 2425 010 000

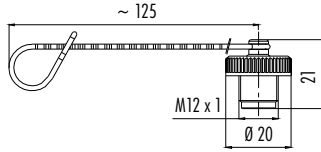

Protection cap for male panel mount connector, IP67

Hole-Ø D	Ordering-No.
3 mm	08 2615 000 000
12,5 mm	08 2676 000 000

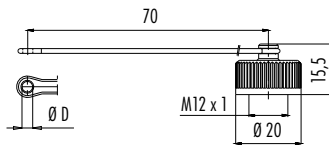

Protection cap for female panel mount connector, IP67

3 mm	08 2616 000 000
12,5 mm	08 2677 000 000

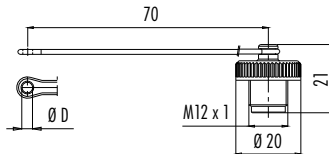

Protection cap for male panel mount connector, IP67, for front mounting

11 mm	08 2989 000 000
14,5 mm	08 2990 000 000

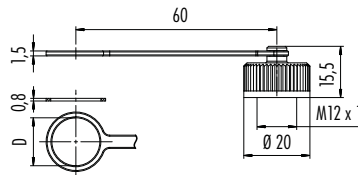

Protection cap for female panel mount connector, IP67, for front mounting

14,5 mm 08 2991 000 000

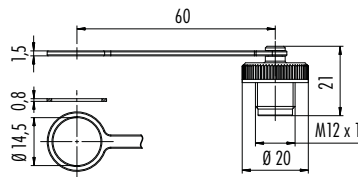

Protection cap for female connector, IP67

**Ordering-No.**  
08 2769 000 000

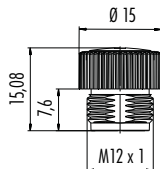

Dummy plug PG 9/M16 x1,5

Thread	Ordering-No.
PG 9	08 3128 000 000
M16 x 1,5	08 3129 000 000

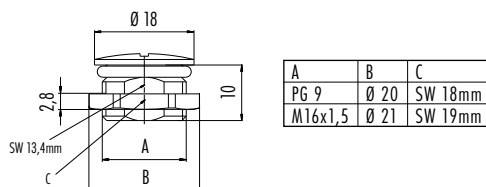

### Description

Hexagonal nut for fixing thread

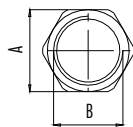

Gewinde B Thread B	Schlüsselweite A Wrench size A
PG 9	SW18 mm
PG 11	SW21 mm
PG 13,5	SW23 mm
M16 x 1,5	SW19 mm
M20 x 1,5	SW24 mm

### Thread B

### Wrench size A

### Ordering-No.

PG 9	SW 18 mm	16 0402 001
PG 11	SW 21 mm	16 0403 001
PG 13,5	SW 23 mm	16 0401 001
M16 x 1,5	SW 19 mm	16 0916 001
M20 x 1,5	SW 24 mm	16 0917 001

### Ring nut for fixing thread

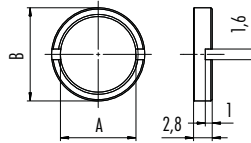

### Thread A

### Diameter B

### Ordering-No.

PG 9	18 mm	01 5322 001
M12 x 1	14 mm	01 5325 001
M16 x 1,5	18 mm	01 5244 001

### Mounting spanner for ring nut

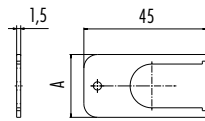

Gewinde/thread	A
PG 9/M16x1,5	23
M12x1	19

### Thread

### Measure A

### Ordering-No.

PG 9/M16 x 1,5	23 mm	07 0084 000
M12 x 1	19 mm	07 0083 000

### Shielding sheet for panel mount connector, fastened from back side

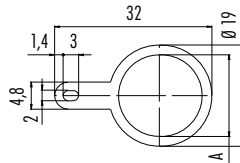

### Thread

### Measure A

### Ordering-No.

PG 9	15,3 mm	04 0734 124
M16 x 1,5	16,1 mm	04 0735 124

### Flat seal for fixing thread PG 9/M16 x 1,5

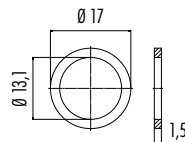

### Ordering-No.

16 1125 071

### Sleeve against inadvertent unmating under load

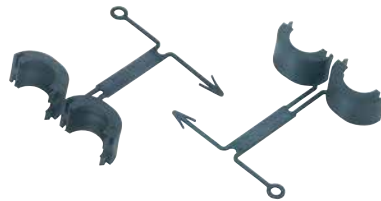

16 0977 000

### Seal for plastic rectangular flange connector

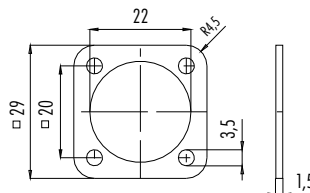

16 8091 000

### Seal for metal rectangular flange connector

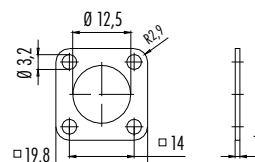

16 0959 000



### Description

### Drawing

### Ordering-No.

Screwing for tube

02 0273 000

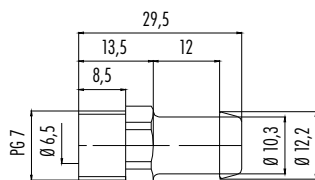

PCB with one LED green/yellow, for mounting in cable connectors, screw termination

08 0462 000 000

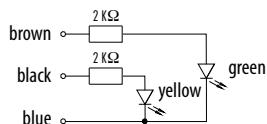
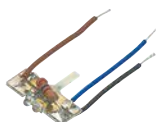

Hexagon torque spanner SW 13 mm, 0,6 Nm

07 0086 000

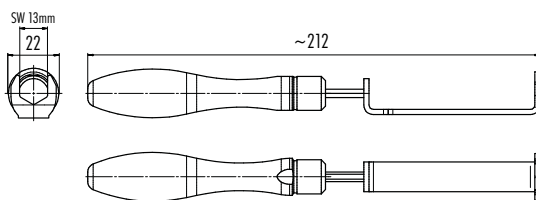

Hexagon torque spanner SW 18 mm, 0,6 Nm

07 0079 000

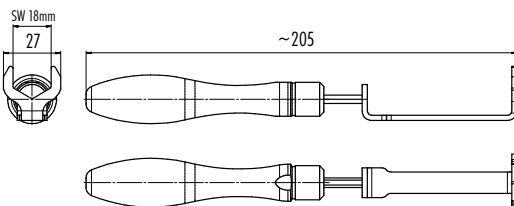

Mounting tool for M12 locking ring

07 0078 000



Single contact (Male), PU = 100 pieces

**Wire gauge**    **AWG**    **Pieces**    **Ordering-No.**

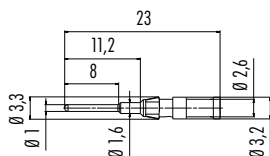

0,14 – 0,34 mm<sup>2</sup>    26–22    100    61 1224 146

0,34 – 0,5 mm<sup>2</sup>    22–20    100    61 1154 146

0,75 – 1,0 mm<sup>2</sup>    18–16    100    61 1225 146

1,0 – 1,5 mm<sup>2</sup>    16    100    61 1226 146

Single contact (Female), PU = 100 pieces

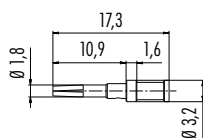

0,14 – 0,34 mm<sup>2</sup>    26–22    100    61 1227 146



0,34 – 0,5 mm<sup>2</sup>    22–20    100    61 1155 146

0,75 – 1,0 mm<sup>2</sup>    18–16    100    61 1228 146

1,0 – 1,5 mm<sup>2</sup>    16    100    61 1229 146

Description	Drawing	Ordering-No.
Crimping tool for turned crimp contacts		66 0003 001
Extraction tool for turned crimp contacts		66 0004 001





- Screw locking acc. to DIN EN 61076-2
- Degree of protection IP67/IP68
- Moulded versions
- M12 A-Coding

### Description

### Drawing

### Contacts Cable length, PUR<sup>1)</sup> Ordering-No.

Male cable connector M8 x 1 – Female cable connector M8 x 1

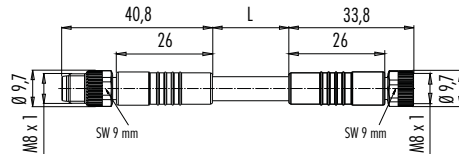

Contacts	Cable length, PUR <sup>1)</sup>	Ordering-No.
3 x 0,25	1 m	79 5032 10 03
	2 m	79 5032 20 03
4 x 0,25	1 m	79 5033 10 04
	2 m	79 5033 20 04

Male cable connector M8 x 1 – Female angled connector M8 x 1

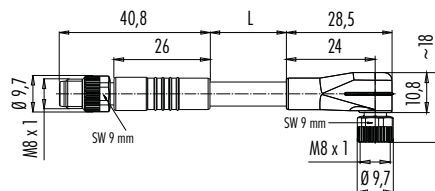

3 x 0,25	1 m	79 5050 10 03
	2 m	79 5050 20 03
4 x 0,25	1 m	79 5037 10 04
	2 m	79 5037 20 04

Male cable connector M8 x 1 – Female cable connector M12 x 1

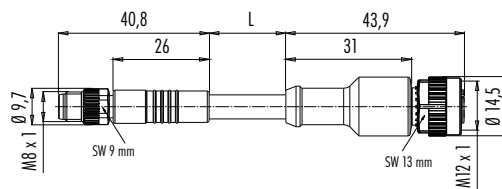

3 x 0,25	1 m	79 5072 10 03
	2 m	79 5072 20 03
4 x 0,25	1 m	79 5073 10 04
	2 m	79 5073 20 04

Male cable connector M8 x 1 – Female angled connector M12 x 1

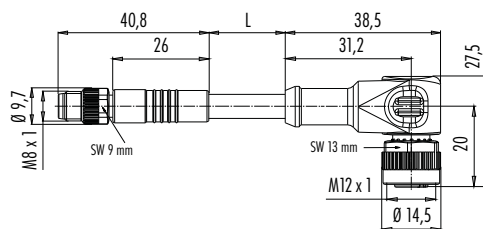

3 x 0,25	1 m	79 5076 10 03
	2 m	79 5076 20 03
4 x 0,25	1 m	79 5077 10 04
	2 m	79 5077 20 04

### Specifications

Contacts	3	M12-A: 4, 4/3 M12-S: 3+PE M12-T: 4	5
Wire gauge	M8: 0,25 mm <sup>2</sup> (AWG 24), M12: 0,34 mm <sup>2</sup> (AWG 22)		M12: 0,25 mm <sup>2</sup> (AWG 24)
Mechanical operation	> 100 Mating cycles		
Temperature range	- 25 °C / + 85 °C		
Rated voltage	M8: 60 V, M12-A: 250 V, 10–30 V with LED, M12-S: 630 V, M12-T: 63 V	M8: 30 V, M12: 250 V, 10–30 V with LED	M12: 60 V
Pollution degree	3		
Rated current (40°C)	M8/M12-A: 4 A M12-S/-T: 12 A		
Contact plating	Au (Gold)		
Material of housing	PUR		

### Description

### Drawing

### Contacts

### Cable length, PUR<sup>1)</sup>

### Ordering-No.

Male cable connector M12 x 1 – Female cable connector M8 x 1

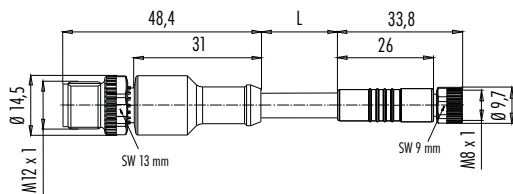

3 x 0,25	1 m	79 5008 10 03
	2 m	79 5008 20 03
4 x 0,25	1 m	79 5009 10 04
	2 m	79 5009 20 04

Male cable connector M12 x 1 – Female angled connector M8 x 1

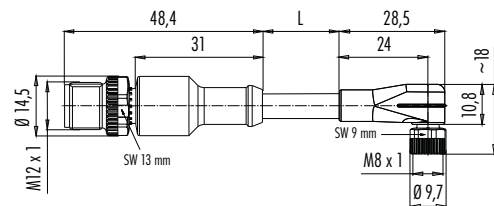

3 x 0,25	1 m	79 5100 10 03
	2 m	79 5100 20 03
4 x 0,25	1 m	79 5101 10 04
	2 m	79 5101 20 04

Male cable connector M12 x 1 – Female angled connector M8 x 1 with LED, PNP

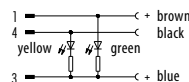
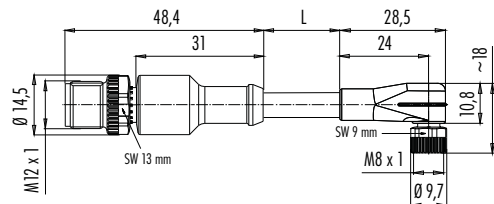

3 x 0,34	1 m	79 5011 10 03
	2 m	79 5011 20 03

Male cable connector M12 x 1 – Female cable connector M12 x 1

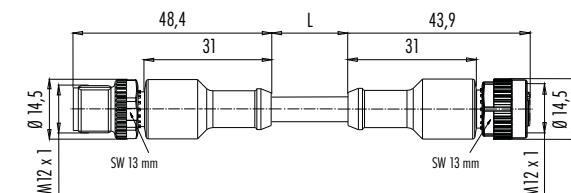

3 x 0,34	1 m	79 5000 10 04
	2 m	79 5000 20 04
4 x 0,34	1 m	79 5001 10 04
	2 m	79 5001 20 04
5 x 0,25	1 m	79 5002 10 05
	2 m	79 5002 20 05

Male cable connector M12 x 1 – Female cable connector M12 x 1, PVC (grey), stainless steel locking ring, Food and Beverage

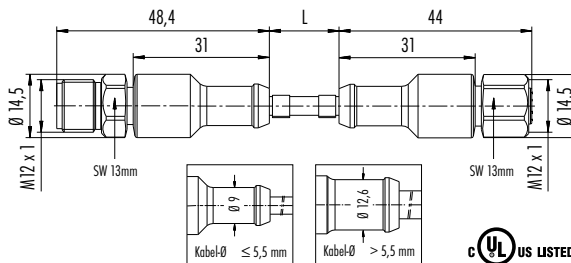

### Contacts

### Cable length, PVC<sup>1)</sup>

### Ordering-No.

3 x 0,34	2 m	77 3730 3729 20403-0200
	5 m	77 3730 3729 20403-0500
4 x 0,34	2 m	77 3730 3729 20404-0200
	5 m	77 3730 3729 20404-0500
5 x 0,34	2 m	77 3730 3729 20405-0200
	5 m	77 3730 3729 20405-0500
8 x 0,25	2 m	77 3730 3729 20908-0200
	5 m	77 3730 3729 20908-0500
12 x 0,25	2 m	77 3730 3729 20912-0200
	5 m	77 3730 3729 20912-0500

Male cable connector M12 x 1 – Female cable connector M12 x 1, PUR (black), Power

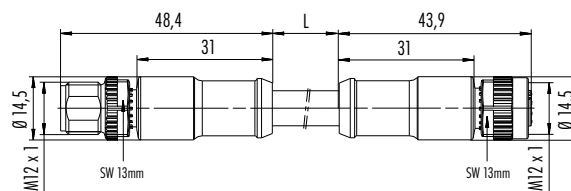

### Contacts

### Cable length, PUR<sup>1)</sup>

### Ordering-No.

4 x 1,5	2 m	77 0606 0605 50704-0200
	5 m	77 0606 0605 50704-0500

<sup>1)</sup>Other lengths upon request.

# Connecting Cables

**Description**

**Drawing**

**Contacts**

**Cable length, PUR <sup>1)</sup>**

**Ordering-No.**

Male cable connector M12 x 1, S-Coding – Female cable connector M12 x 1, S-Coding, PUR (black),  
 ■ Power

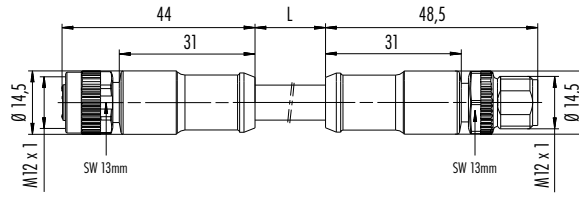

3+PE x 1,5	2 m	77 0690 0689 50704-0200
	5 m	77 0690 0689 50704-0500

Male cable connector M12 x 1, T-Coding – Female cable connector M12 x 1, T-Coding, PUR (black),  
 ■ Power

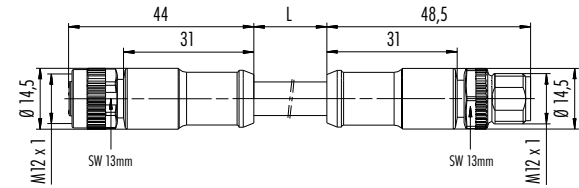

4 x 1,5	2 m	77 0630 0629 50704-0200
	5 m	77 0630 0629 50704-0500

Male cable connector M12 x 1 – Female angled connector M12 x 1

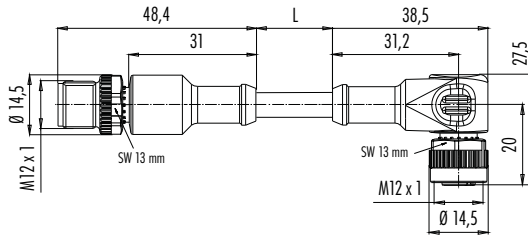

3 x 0,34	1 m	79 5027 10 04
	2 m	79 5027 20 04
4 x 0,34	1 m	79 5028 10 04
	2 m	79 5028 20 04
5 x 0,25	1 m	79 5029 10 05
	2 m	79 5029 20 05

Male cable connector M12 x 1 – Female angled connector M12 x 1, PVC (grey), stainless steel locking ring,  
 Food and Beverage

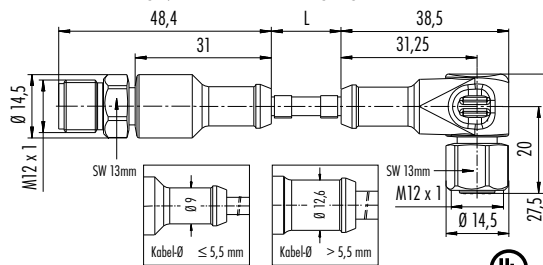

Contacts	Cable length, PVC <sup>1)</sup>	Ordering-No.
3 x 0,34	2 m	77 3734 3729 20403-0200
	5 m	77 3734 3729 20403-0500
4 x 0,34	2 m	77 3734 3729 20404-0200
	5 m	77 3734 3729 20404-0500
5 x 0,34	2 m	77 3734 3729 20405-0200
	5 m	77 3734 3729 20405-0500
8 x 0,25	2 m	77 3734 3729 20908-0200
	5 m	77 3734 3729 20908-0500
12 x 0,25	2 m	77 3734 3729 20912-0200
	5 m	77 3734 3729 20912-0500

Male cable connector M12 x 1 – Female angled connector M12 x 1 with LED, PNP

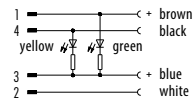
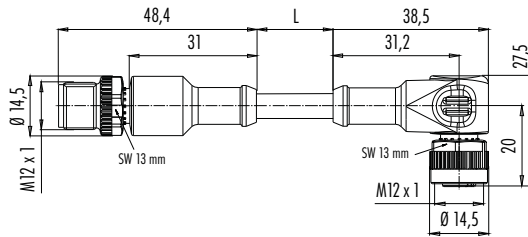

Contacts	Cable length, PUR <sup>1)</sup>	Ordering-No.
3 x 0,34	1 m	79 5003 10 04
	2 m	79 5003 20 04
4 x 0,34	1 m	79 5004 10 04
	2 m	79 5004 20 04

Male angled connector M12 x 1 – Female cable connector M12 x 1, PVC (grey), stainless steel locking ring,  
 Food and Beverage

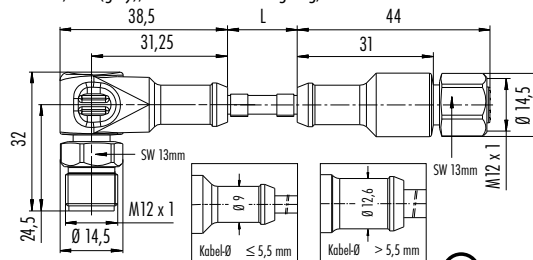

Contacts	Cable length, PVC <sup>1)</sup>	Ordering-No.
3 x 0,34	2 m	77 3730 3727 20403-0200
	5 m	77 3730 3727 20403-0500
4 x 0,34	2 m	77 3730 3727 20404-0200
	5 m	77 3730 3727 20404-0500
5 x 0,34	2 m	77 3730 3727 20405-0200
	5 m	77 3730 3727 20405-0500
8 x 0,25	2 m	77 3730 3727 20908-0200
	5 m	77 3730 3727 20908-0500
12 x 0,25	2 m	77 3730 3727 20912-0200
	5 m	77 3730 3727 20912-0500

# Connecting Cables

## Description

Male angled connector M12 x 1 – Female angled connector M12 x 1, PVC (grey), stainless steel locking ring, Food and Beverage



## Drawing

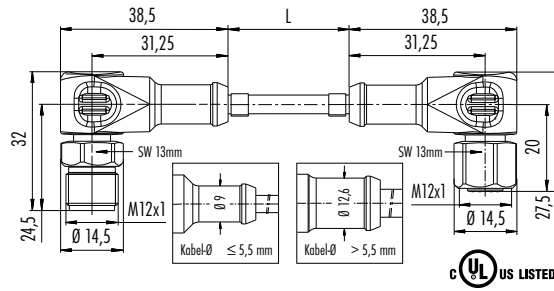

## Contacts

## Cable length, PVC <sup>1)</sup>

## Ordering-No.

3 x 0,34	2 m	77 3734 3727 20403-0200
	5 m	77 3734 3727 20403-0500
4 x 0,34	2 m	77 3734 3727 20404-0200
	5 m	77 3734 3727 20404-0500
5 x 0,34	2 m	77 3734 3727 20405-0200
	5 m	77 3734 3727 20405-0500
8 x 0,25	2 m	77 3734 3727 20908-0200
	5 m	77 3734 3727 20908-0500
12 x 0,25	2 m	77 3734 3727 20912-0200
	5 m	77 3734 3727 20912-0500

<sup>1)</sup>Other lengths upon request.

### Description

### Drawing

### Contacts

### Cable length, PUR <sup>1)</sup>

### Ordering-No.

Male duo connector M12 x 1 – 2 female cable connectors M8 x 1

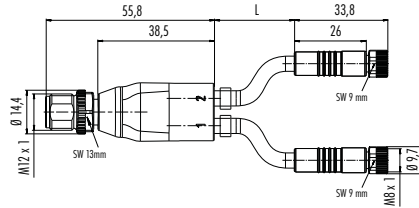

4/3 x 0,34

1 m

79 5204 10 04

2 m

79 5204 20 04

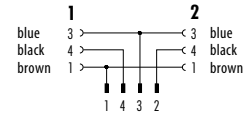

Male duo connector M12 x 1 – 2 female angled connectors M8 x 1 with LED, PNP

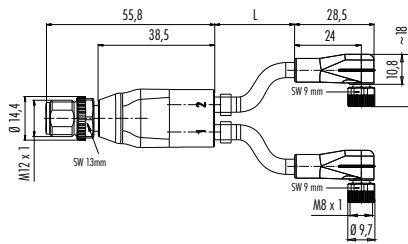

4/3 x 0,34

1 m

79 5206 10 04

2 m

79 5206 20 04

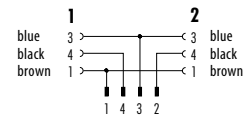

Male angled duo connector M12 x 1 – 2 female cable connectors M8 x 1

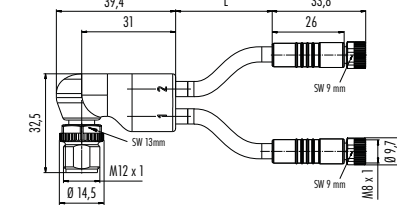

4/3 x 0,34

1 m

77 9827 3406 50003-0100

2 m

77 9827 3406 50003-0200

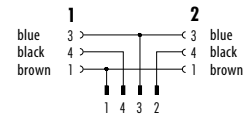

Male duo connector M12 x 1 – 2 female cable connectors M12 x 1

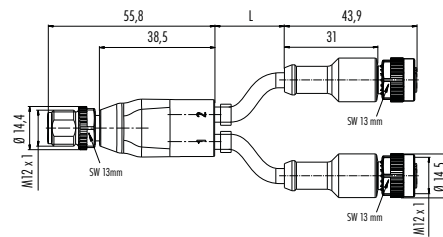

4/3 x 0,34

1 m

79 5200 10 04

2 m

79 5200 20 04

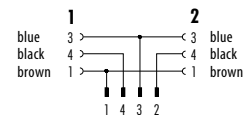

Male duo connector M12 x 1 – 2 female cable connectors M12 x 1, CAN-Bus

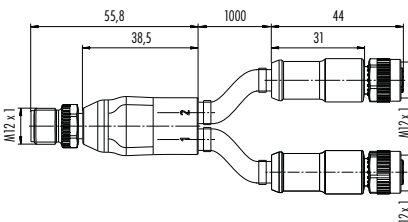

5

2 x 0,34

1 m

79 5229 10 05

2 x 0,25

2 m

79 5229 20 05

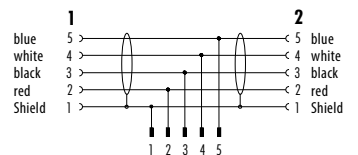

Male angled duo connector M12 x 1 – 2 female cable connectors M12 x 1

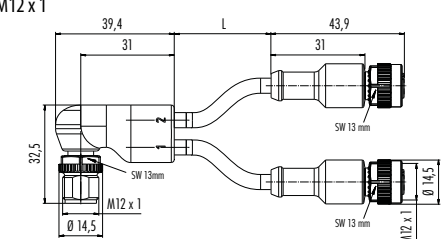

4/3 x 0,34

1 m

77 9827 3430 50003-0100

2 m

77 9827 3430 50003-0200

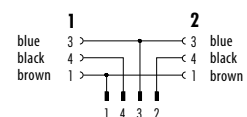



# Adapter · Twin Distributors

**Description**

**Drawing**

**Contacts**

**Ordering-No.**

Adapter, male connector M8 x 1 – female connector M12 x 1

3	09 5283 00 03
4	09 5284 00 04

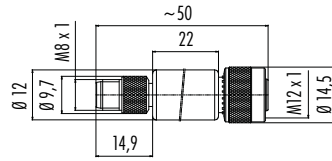

Adapter, female connector M8 x 1 – male connector M12 x 1

3	09 5280 00 03
4	09 5281 00 04

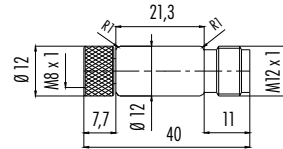

Adapter, lead-through for control cabinet, male connector M8 x 1 – female connector M8 x 1, shielded

3	09 5250 00 03
4	09 5251 00 04

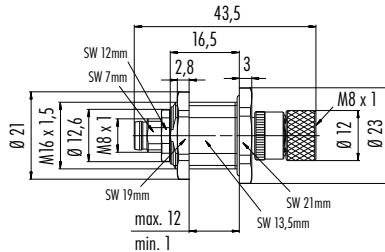

Adapter, lead-through for control cabinet, male connector M12 x 1 – female connector M12 x 1, shielded

4	09 5240 00 04
5	09 5241 00 05
8	09 5244 00 08

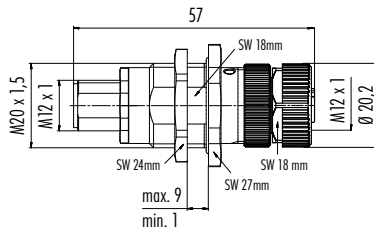

Twin distributor, moulded – 2 female connectors M8 x 1, LED

Contacts	Cable length, PUR	Ordering-No.
3 x 0,25	2 m	79 5232 33 04

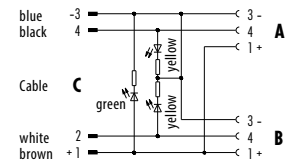
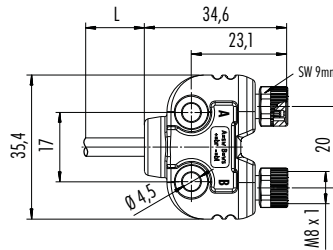

Twin distributor, moulded – male connector/female connector M12 x 1

4 x 0,25	1 m	79 5238 10 04
	2 m	79 5238 20 04

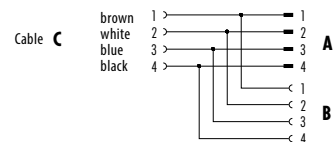
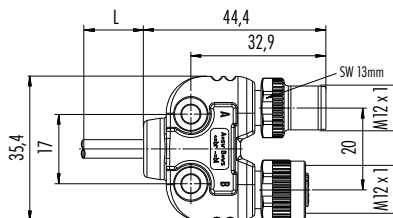

# Twin distributors

**Description**

**Drawing**

**Contacts**

**Ordering-No.**

Y-distributor, Male connector M8 x 1 – 2 Female connectors M8 x 1

4/3

79 5280 00 04

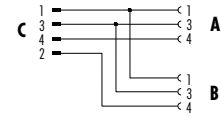
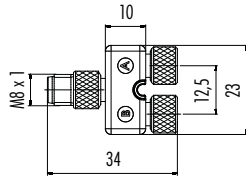

Y-distributor, male connector M8 x 1 – 2 female connectors M8 x 1, screw on

4/3

79 5232 70 04

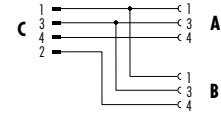
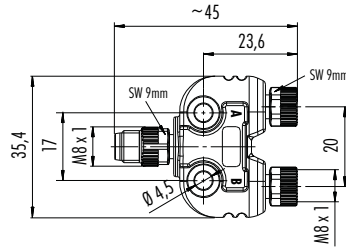

Y-distributor, male connector M12 x 1 – 2 female connectors M8 x 1

4/3

79 5204 00 04

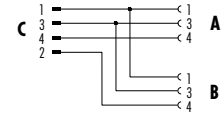
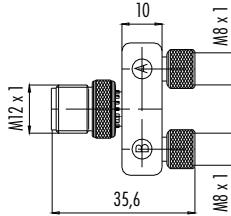

Y-distributor, male connector M12 x 1 – 2 female connectors M8 x 1, screw on

4/3

79 5232 90 04

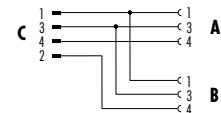
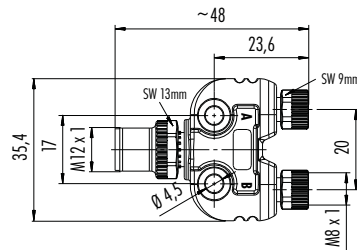

Y-distributor, male connector M12 x 1 – 2 female connectors M8 x 1, Led, screw on

4/3

79 5232 00 04

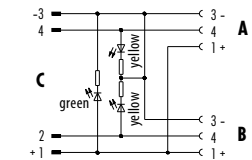
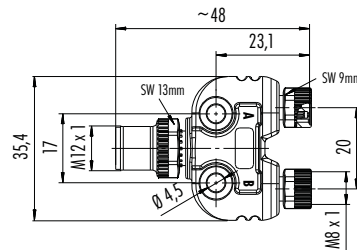

Y-distributor, male connector M12 x 1 – 2 female connectors M12 x 1

4

79 5200 00 04

5/4

79 5207 00 05

5

79 5208 00 05

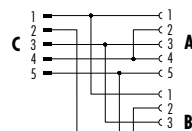
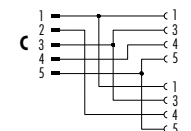
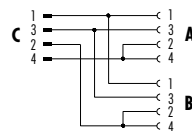
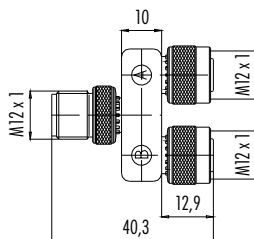

# Twin distributors

**Description**

**Drawing**

**Contacts**

**Ordering-No.**

Y-distributor, 1:1 wiring, male connector M12 x 1 – 2 female connectors M12 x 1

5 79 5210 00 05  
8 79 5211 00 08

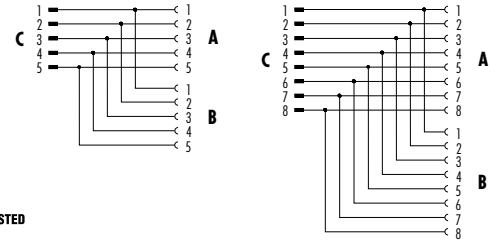
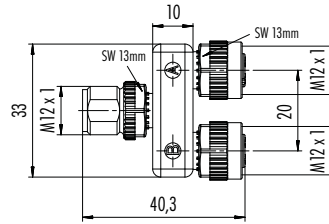

T-distributor, male connector M12 x 1 – 2 female connectors M12 x 1, screw on

5 79 5256 100 05

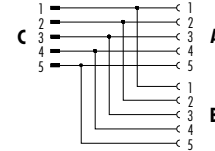
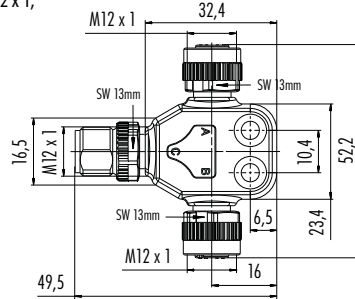

Y-distributor, male connector M12 x 1 – 2 female connectors M12 x 1, screw on

4/3 79 5236 90 04  
5 79 5236 40 05

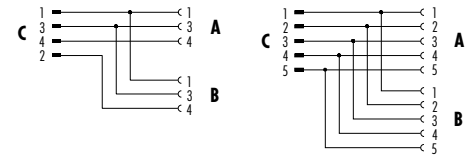
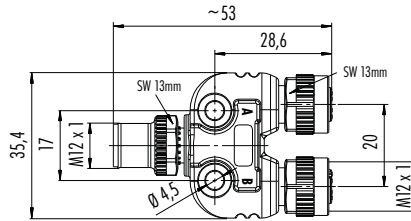

Y-distributor, 1:1 wiring, male connector M12 x 1 – 2 female connectors M12 x 1, stainless steel version

5 79 5210 17 05

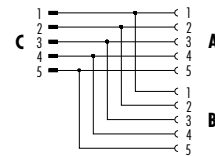
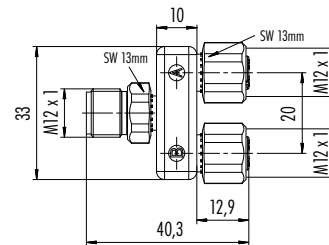

Y-distributor, 1:1 wiring, female connector M12 x 1 – male connector/female connector M12 x 1

5 79 5212 00 05

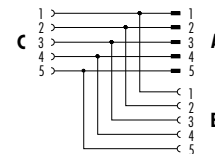
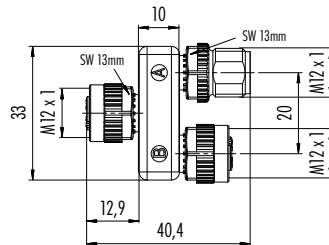

T-distributor, female connector M12 x 1 – male connector/female connector M12 x 1, screw on

4 79 5254 100 04  
5 79 5255 100 05

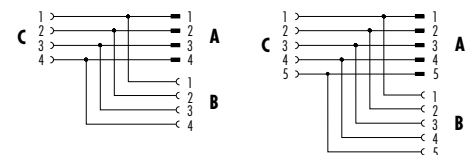
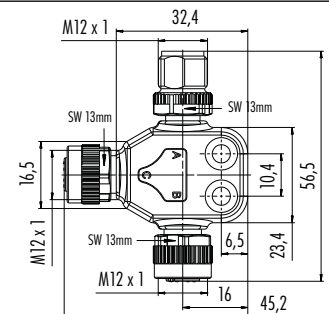



- Screw locking acc. to DIN EN 61076-2-101
- Degree of protection IP67
- Moulded versions  
Degree of protection IP68
- Easy assembly
- Excellent EMC shielding
- Versions with shielding rings/iris type spring
- Angled connectors adjustable in 4 positions

**Description**

**Drawing**

Male cable connector, screw clamp/wire clamp, with shielding ring, shieldable

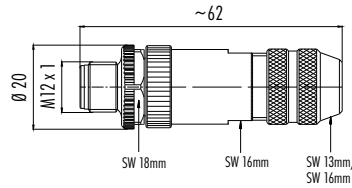

Contacts	Cable outlet	Screw clamp	Wire clamp
4	6–8 mm	99 1429 810 04	c  –
	6–8 mm	99 1437 810 05	c  99 1535 810 05
5	6,5–8,5 mm	99 1437 910 05	c  99 1535 910 05
	8–10 mm	99 1437 935 05	c  –

Male cable connector, screw clamp/wire clamp, iris type spring, shieldable

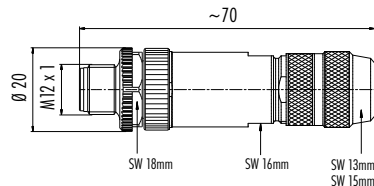

5	5–8 mm	99 1439 810 05	c  99 1533 810 05
	8–9 mm	99 1439 910 05	c  99 1533 910 05

Male cable connector, screw clamp, with shielding ring, stainless steel version, shieldable

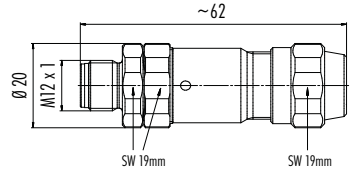

4	5,5–8,6 mm	99 1429 995 04	
5		99 1437 995 05	



Male cable connector, crimp, shieldable

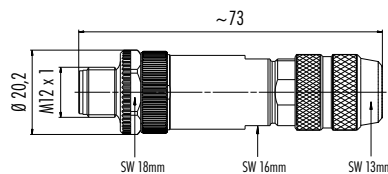

4	5–8 mm	99 1433 810 04	
---	--------	----------------	--



Crimp contacts see page 160

**Specifications**

Contacts	4	5
Wire gauge	screw clamp max. 0,75 mm <sup>2</sup> (max. AWG 20), wire clamp max. 0,5 mm <sup>2</sup> (max. AWG 20)	
Mechanical operation	Optalloy > 50 Mating cycles, Gold > 100 Mating cycles	
Temperature range	– 40 °C / + 85 °C	
Rated voltage	250 V	60 V
Pollution degree	3	
Rated current (40°C)	4 A	
Contact plating	plastic versions: CuSnZn (Optalloy), others Au (Gold)	
Material of housing	PA, straight, shielded version CuZn (brass nickel plated), angled shielded versions zinc diecasting nickel plated	

**Description**

Male cable connector, metal locking system, screw clamp

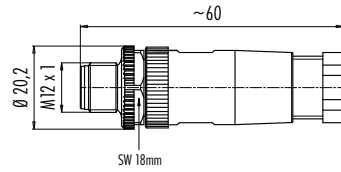

**Contacts Cable outlet Ordering-No.**

4	4-6 mm	99 0429 15 04
	6-8 mm	99 0429 105 04
5	4-6 mm	99 0437 15 05
	6-8 mm	99 0437 105 05

Male angled connector, metal locking system, screw clamp

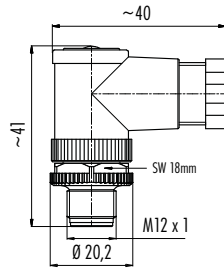

4	4-6 mm	99 0429 135 04
	6-8 mm	99 0429 145 04
5	4-6 mm	99 0437 135 05
	6-8 mm	99 0437 145 05

Male angled connector, screw clamp/wire clamp, with shielding ring, shieldable

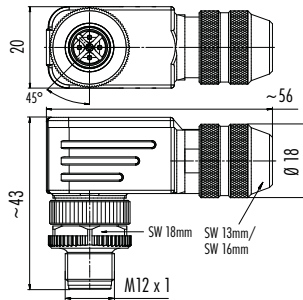

It is possible to turn and fix the contact carrier in 4 different 90° positions

**Contacts Cable outlet Screw clamp Wire clamp**

4	6-8 mm	99 1429 820 04		-
	6-8 mm	99 1437 820 05		99 1535 820 05
5	6,5-8,5 mm	99 1437 920 05		99 1535 920 05

Male angled connector, screw clamp/wire clamp, iris type spring, shieldable

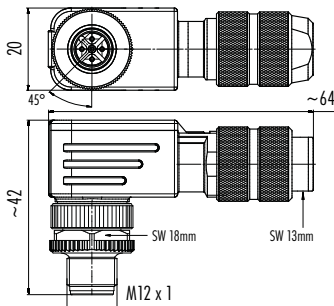

It is possible to turn and fix the contact carrier in 4 different 90° positions

5	5-8 mm	99 1439 820 05		99 1533 820 05
---	--------	----------------	--	----------------

Male angled connector, crimp, shieldable



4	5-8 mm	99 1433 820 04
---	--------	----------------

Crimp contacts see page 160

## Component part drawing

Cable connectors, with shielding ring, shieldable

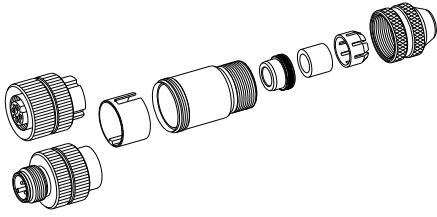

- Female insert/ Male insert
- Insulating sleeve tightly built into coupling sleeve
- Shielding ring
- O-ring
- Seal
- Pinch ring
- Pressing screw

Cable connectors, with iris type spring, shieldable

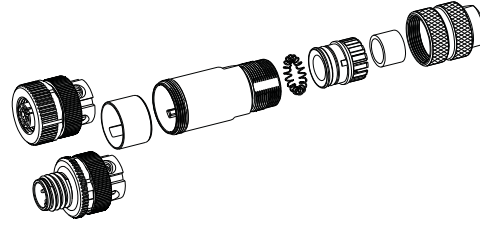

- Female insert/ Male insert
- Insulating sleeve, Sleeve, Pressing spring, O-ring, Pinch ring, Seal, Pressing screw are premounted

Angled connectors, shieldable

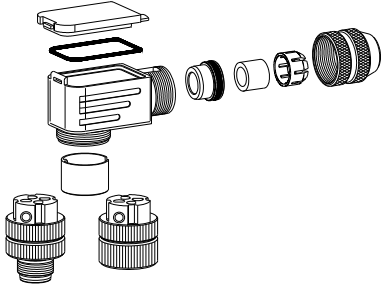

- Female insert/ Male insert
- Insulating sleeve tightly built into coupling sleeve
- Housing
- Seal
- Cover
- Shielding ring
- O-ring
- Seal
- Pinch ring
- Pressing screw

Angled connectors, with iris type spring, shieldable

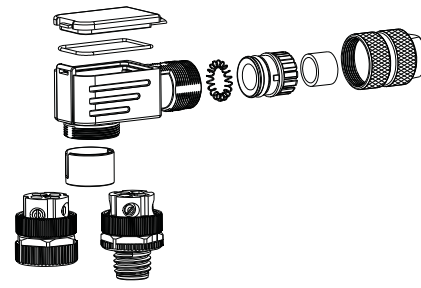

- Female insert/ Male insert
- Insulating sleeve, Housing, Pressing spring, O-ring, Pinch ring, Seal, Pressing screw are premounted
- O-ring
- Cover

## Contact arrangements male insert (mating side)

2/4 contacts

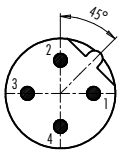

3 contacts

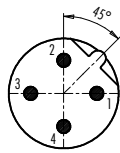

4 contacts

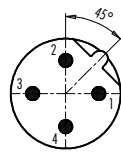

5 contacts

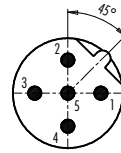

## Contact arrangements female insert (mating side)

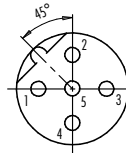
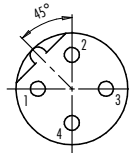
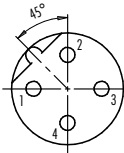
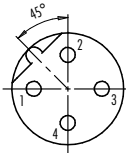

## Colour of wire, moulded cable and panel mount connectors

2/4 contacts PROFIBUS	3 contacts	4 contacts	5 contacts
1 not connected	1 brown	1 brown	1 brown
2 green	2 not connected	2 white	2 white
3 not connected	3 blue	3 blue	3 blue
4 red	4 black	4 black	4 black
			5 grey

Shield = Coupling ring

**Description**

Male cable connector, moulded, PVC (grey), PUR (black)

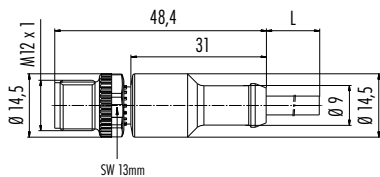

**Contacts**

**Cable length**

**PVC<sup>1)</sup>**

**PUR<sup>1)</sup>**

3 x 0,34	2 m	77 4429 0000 20003-0200	77 4429 0000 50003-0200
	5 m	77 4429 0000 20003-0500	77 4429 0000 50003-0500
4 x 0,34	2 m	77 4429 0000 20004-0200	77 4429 0000 50004-0200
	5 m	77 4429 0000 20004-0500	77 4429 0000 50004-0500
5 x 0,25	2 m	77 4429 0000 20005-0200	77 4429 0000 50005-0200
	5 m	77 4429 0000 20005-0500	77 4429 0000 50005-0500

Male angled connector, moulded, PVC (grey), PUR (black)

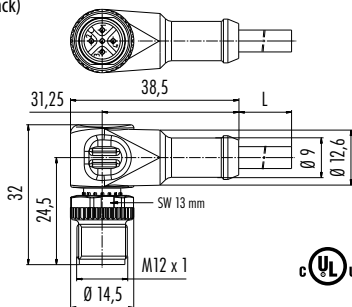

3 x 0,34	2 m	77 4427 0000 20003-0200	77 4427 0000 50003-0200
	5 m	77 4427 0000 20003-0500	77 4427 0000 50003-0500
4 x 0,34	2 m	77 4427 0000 20004-0200	77 4427 0000 50004-0200
	5 m	77 4427 0000 20004-0500	77 4427 0000 50004-0500
5 x 0,25	2 m	77 4427 0000 20005-0200	77 4427 0000 50005-0200
	5 m	77 4427 0000 20005-0500	77 4427 0000 50005-0500

Male cable connector, shielded, PROFIBUS

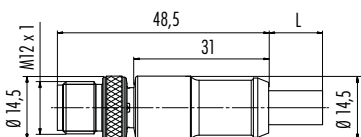

**Contacts**   **Cable length**   **Ordering-No.<sup>1)</sup>**

2	2 m	77 4329 0000 60702-0200
	5 m	77 4329 0000 60702-0500
	10 m	77 4329 0000 60702-1000

Male terminating connector, PROFIBUS

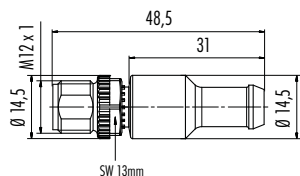

**Wiring diagram**

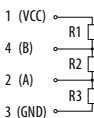

4	-	77 9835 0000 00004
---	---	--------------------

**Specifications**

**Cable connectors, moulded**

Contacts	2 PROFIBUS	3	4	5
Wire gauge	0,25 mm <sup>2</sup> (AWG 24)	0,34 mm <sup>2</sup> (AWG 22)		
Mechanical operation	> 100 Mating cycles			
Temperature range	- 25 °C /+ 80 °C	- 25 °C /+ 90 °C (+ 80 °C UL)		
Rated voltage	60 V	250 V	60 V	
Pollution degree	3			
Rated current (40°C)	1 A	4 A		
Contact plating	Au (Gold)			
Material of housing	PUR			

<sup>1)</sup> Standard cable length is 2 m/5 m. Other lengths upon request.

**Description**

Female cable connector, moulded, PVC (grey), PUR (black)

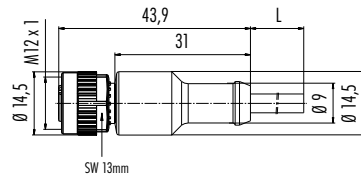

**Contacts**

**Cable length**

**PVC<sup>1)</sup>**

**PUR<sup>1)</sup>**

3 x 0,34	2 m	77 4430 0000 20003-0200	77 4430 0000 50003-0200
	5 m	77 4430 0000 20003-0500	77 4430 0000 50003-0500
4 x 0,34	2 m	77 4430 0000 20004-0200	77 4430 0000 50004-0200
	5 m	77 4430 0000 20004-0500	77 4430 0000 50004-0500
5 x 0,25	2 m	77 4430 0000 20005-0200	77 4430 0000 50005-0200
	5 m	77 4430 0000 20005-0500	77 4430 0000 50005-0500

Female angled connector, moulded, PVC (grey), PUR (black)

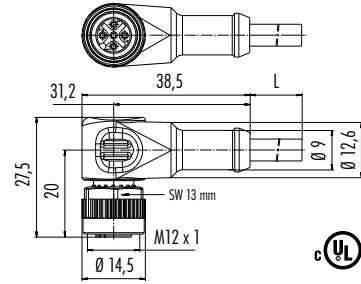

3 x 0,34	2 m	77 4434 0000 20003-0200	77 4434 0000 50003-0200
	5 m	77 4434 0000 20003-0500	77 4434 0000 50003-0500
4 x 0,34	2 m	77 4434 0000 20004-0200	77 4434 0000 50004-0200
	5 m	77 4434 0000 20004-0500	77 4434 0000 50004-0500
5 x 0,25	2 m	77 4434 0000 20005-0200	77 4434 0000 50005-0200
	5 m	77 4434 0000 20005-0500	77 4434 0000 50005-0500

Female cable connector, shielded, PROFIBUS

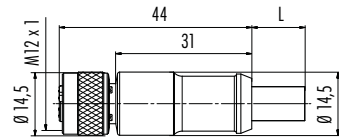

**Contacts** **Cable length** **Ordering-No.<sup>1)</sup>**

2	2 m	77 4330 0000 60702-0200
	5 m	77 4330 0000 60702-0500
	10 m	77 4330 0000 60702-1000

**Specifications**

**Standard Cable**

	3		4		5	
Contacts	3		4		5	
Wire gauge	3 x 0,34 mm <sup>2</sup> (AWG 22)		4 x 0,34 mm <sup>2</sup> (AWG 22)		5 x 0,34 mm <sup>2</sup> (AWG 24)	
Material jacket	PVC grey	PUR	PVC grey	PUR	PVC grey	PUR
Insulation of wire	PVC grey	PP	PVC grey	PP	PVC grey	PP
Design of wire (mm)	42 x 0,1					
Cable diameter (mm)	4,5	4,3	4,8	4,7	4,8	4,7
Temperature range cable in move	PVC: -5 °C / + 105 °C PUR: -25 °C / + 90 °C (in chain flex application + 60 °C)					
Temperature range cable fixed	PVC: -40 °C / + 105 °C PUR: -50 °C / + 90 °C					
Bending radius (at 10 x D)	2 Mio.	5 Mio.	2 Mio.	5 Mio.	2 Mio.	5 Mio.
Approval	UL/CSA					
UL-style	PVC: AWM 2517 PUR: AWM 20549					
Chain flex application	bending radius min. 10 x D, permitted acceleration 5 m/s <sup>2</sup>					

**Specifications**

**PROFIBUS Cable**

Contacts	2
Wire gauge	1 x 2 x 0,25 mm <sup>2</sup> (AWG 24)
Material jacket	PUR
Insulation of wire	PE foam
Design of wire (mm)	19 x 0,127 (AWG 24 x 19)
Cable diameter (mm)	7,8
UL-style	AWM 20236



**Description**

Female cable connector, metal locking system, screw clamp

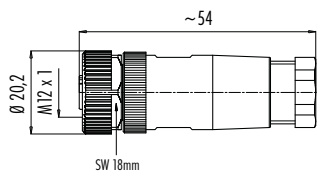

**Contacts Cable outlet Ordering-No.**

Contacts	Cable outlet	Ordering-No.
4	4-6 mm	99 0430 25 04
	6-8 mm	99 0430 225 04
5	4-6 mm	99 0436 25 05
	6-8 mm	99 0436 225 05

Female cable connector, screw clamp/wire clamp, with shielding ring, shieldable

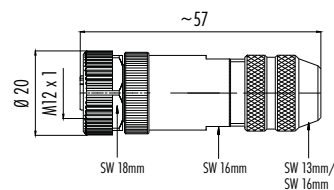

**Contacts Cable outlet Screw clamp Wire clamp**

Contacts	Cable outlet	Screw clamp	Wire clamp
4	6-8 mm	99 1430 810 04	c RL US -
	6-8 mm	99 1436 810 05	c RL US 99 1536 810 05
5	6,5-8,5 mm	99 1436 910 05	c RL US 99 1536 910 05
	8-10 mm	99 1436 935 05	c RL US -

Female cable connector, screw clamp/wire clamp, iris type spring, shieldable

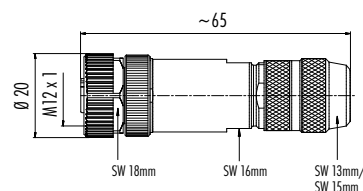

5	5-8 mm	99 1438 810 05	c RL US 99 1534 810 05
	8-9 mm	99 1438 910 05	c RL US 99 1534 910 05

Female cable connector, screw clamp, with shielding ring, stainless steel version, shieldable

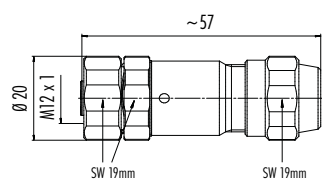

4	5,5-8,6 mm	99 1430 995 04
5		99 1436 995 05

Female cable connector, crimp, shieldable

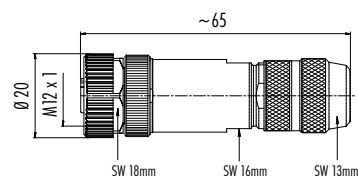

4	5-8 mm	99 1434 810 04
---	--------	----------------

Crimp contacts see page 160

**Description**

Female angled connector, metal locking system, screw clamp

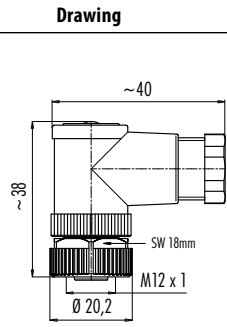

Contacts	Cable outlet	Ordering-No.
4	4–6 mm	99 0430 135 04
	6–8 mm	99 0430 235 04
5	4–6 mm	99 0436 135 05
	6–8 mm	99 0436 235 05

Female angled connector, screw clamp/wire clamp, with shielding ring, shieldable

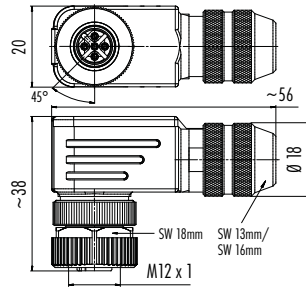

It is possible to turn and fix the contact carrier in 4 different 90° positions

Contacts	Cable outlet	Screw clamp	Wire clamp
4	6–8 mm	99 1430 820 04	c RA US –
	6–8 mm	99 1436 820 05	c RA US 99 1536 820 05
5	6,5–8,5 mm	99 1436 920 05	c RA US 99 1536 920 05

Female angled connector, screw clamp/wire clamp, iris type spring, shieldable

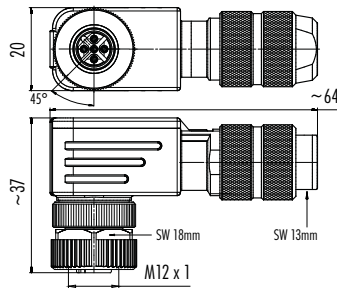

It is possible to turn and fix the contact carrier in 4 different 90° positions

5	5–8 mm	99 1438 820 05	c RA US 99 1534 820 05
---	--------	----------------	------------------------

Female angled connector, crimp, shieldable



4	5–8 mm	99 1434 820 04
---	--------	----------------

Crimp contacts see page 160

Single contact (Male), PU 100 pieces

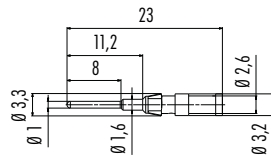

Wire gauge	AWG	Ordering-No.
0,14 mm <sup>2</sup> – 0,34 mm <sup>2</sup>	26–22	61 1224 146
0,34 mm <sup>2</sup> – 0,5 mm <sup>2</sup>	22–20	61 1154 146
0,75 mm <sup>2</sup> – 1,0 mm <sup>2</sup>	18–16	61 1225 146
1,0 mm <sup>2</sup> – 1,5 mm <sup>2</sup>	16	61 1226 146

Single contact (Female), PU 100 pieces

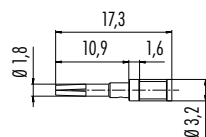

0,14 mm <sup>2</sup> – 0,34 mm <sup>2</sup>	26–22	61 1227 146
0,34 mm <sup>2</sup> – 0,5 mm <sup>2</sup>	22–20	61 1155 146
0,75 mm <sup>2</sup> – 1,0 mm <sup>2</sup>	18–16	61 1228 146
1,0 mm <sup>2</sup> – 1,5 mm <sup>2</sup>	16	61 1229 146

Description	Drawing	Contacts	Fixing thread	Ordering-No.
Male panel mount connector, fixing thread, solder		4	M12 x 0,5	09 0431 90 04
Male panel mount connector, fixing thread, solder		4 5	PG 9 M16 x 1,5	86 4233 1002 00004 86 4333 1002 00004 86 4333 1002 00005
Male panel mount connector, fixing thread, solder		4	PG 11	09 0435 90 04
Male panel mount connector, fixing thread, solder		4 5	PG 13,5 M20 x 1,5	86 4533 1002 00004 86 4633 1002 00004 86 4633 1002 00005



Specifications	Panel mount connector	
Contacts	4	5
Wire gauge	max. 0,25 mm <sup>2</sup> (max. AWG 24), single wires AWG 24 (0,25 mm <sup>2</sup> )	
Mechanical operation	> 100 Mating cycles	
Temperature range	- 40 °C / + 85 °C	
Rated voltage	250 V	60 V
Pollution degree	3	
Rated current (40°C)	4 A	
Contact plating	Au (Gold)	
Material of housing	PA, zinc diecasting nickel plated	

**Description**

Male panel mount connector with single wires, metal housing

**Drawing**

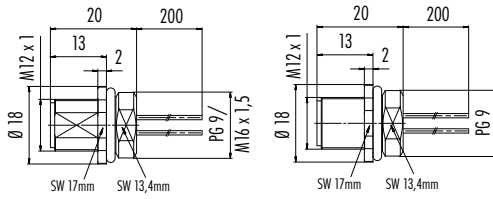

Stainless steel version

**Contacts**

**Fix. thread**

**Ordering-No.**

	PG 9	76 0133 0011 00104-0200
4	M16 x 1,5	76 0233 0011 00104-0200
	PG 9 Stainless steel	76 2133 0111 00104-0200
	PG 9	76 0133 0011 00105-0200
5	M16 x 1,5	76 0233 0011 00105-0200
	PG 9 Stainless steel	76 2133 0111 00105-0200



Male panel mount connector, positioning possible, with single wires, metal housing

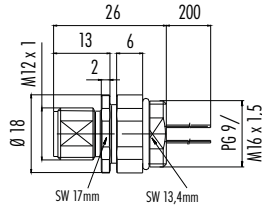

	PG 9	76 0733 0011 00104-0200
4	M16 x 1,5	76 0833 0011 00104-0200
	PG 9	76 0733 0011 00105-0200
5	M16 x 1,5	76 0833 0011 00105-0200

Male panel mount connector, front fastened, with single wires, metal housing

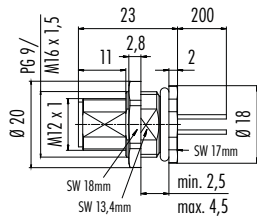

	PG 9	76 0533 1011 00104-0200
5	PG 9	76 0533 1011 00105-0200

Male panel mount connector, dip-solder/front fastened, dip-solder, metal housing

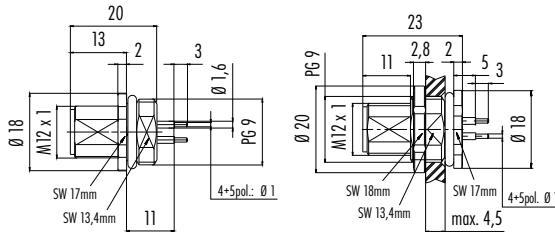

fastened from back side

front fastened



Contacts	Fix. thread	Fastened from back side	Front fastened
4	PG 9	–	86 0533 1000 00004
5	PG 9	86 0133 0000 00005	86 0533 1000 00005

Male panel mount connector, front fastened, dip-solder, metal housing

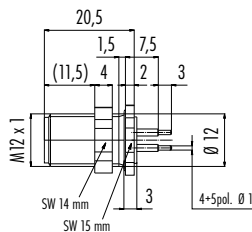

Contacts	Fix. thread	Ordering-No.
4	PG 9	86 1033 1100 00004
5	M12 x 1	86 1033 1100 00005

Male panel mount connector, front fastened, dip-solder, with shielding sheet

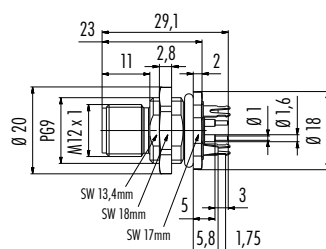

PCB thickness: 1,6 mm

Hexagonal nut enclosed loose



5	PG 9	86 0533 1120 00005
---	------	--------------------

**Description**

Male receptacle for PCB assembly



**Drawing**

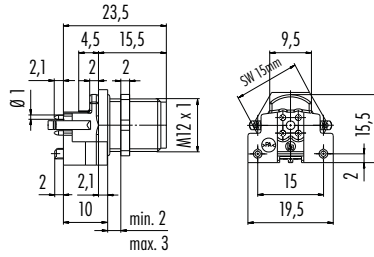

PCB thickness: 1,6 mm

View of mating side



**Contacts Ordering-No.**

5	99 4445 200 05
	99 4445 458 05 with shielding sheet

Male angled receptacle for PCB assembly

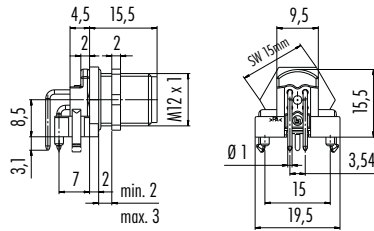

PCB thickness: 1,6 mm

View of mating side



5	99 4445 202 05
	99 4445 601 05 with shielding sheet

Male receptacle, SMT, with housing, shieldable

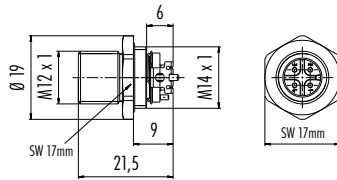

**Contacts Mounting height Ordering-No.**

4	9 mm	99 4431 401 04
5		99 4441 401 05

Male receptacle, SMT, shieldable

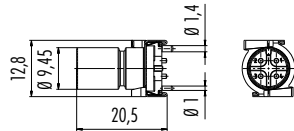

4	-	09 0443 601 04
5		09 0445 601 05

Male panel mount connector M16, with PROFIBUS-cable, shielded

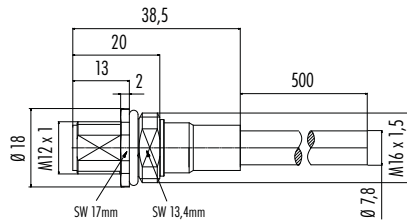

**Contacts Cable length, PUR Fix. thread Ordering-No.**

2 x 0,25	0,5 m	M16 x 1,5	70 4433 246 04
----------	-------	-----------	----------------

Male panel mount connector PG 9, front fastened, with PROFIBUS-cable, shielded

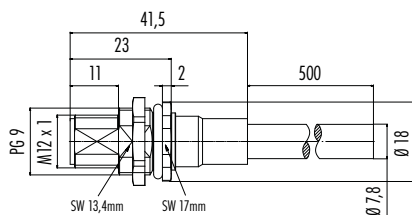

Hexagonal nut enclosed loose

2 x 0,25	0,5 m	PG 9	70 4433 247 04
----------	-------	------	----------------

**Description**

Female panel mount connector with single wires

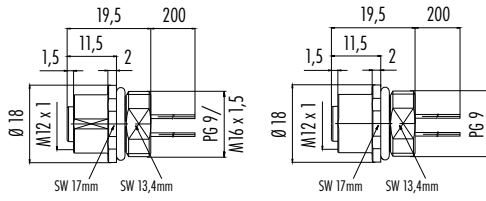

Stainless steel version

**Contacts**

**Fix. thread**

**Ordering-No.**

	PG 9	76 0134 0011 00104-0200
4	M16 x 1,5	76 0234 0011 00104-0200
	PG 9 Stainless steel	76 2134 0111 00104-0200
	PG 9	76 0134 0011 00105-0200
5	M16 x 1,5	76 0234 0011 00105-0200
	PG 9 Stainless steel	76 2134 0111 00105-0200



Female panel mount connector, positioning possible, with single wires, metal housing

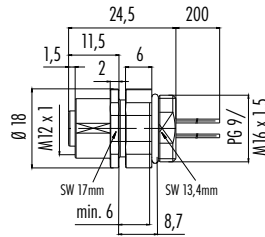

4	PG 9	76 0734 0011 00104-0200
	M16 x 1,5	76 0834 0011 00104-0200
5	PG 9	76 0734 0011 00105-0200
	M16 x 1,5	76 0834 0011 00105-0200

Female panel mount connector, front fastened, with single wires, metal housing

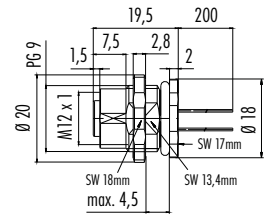

4	PG 9	76 0534 1011 00104-0200
5	PG 9	76 0534 1011 00105-0200

Female panel mount connector, dip-solder, metal housing/front fastened, dip-solder, 6 mm contact length

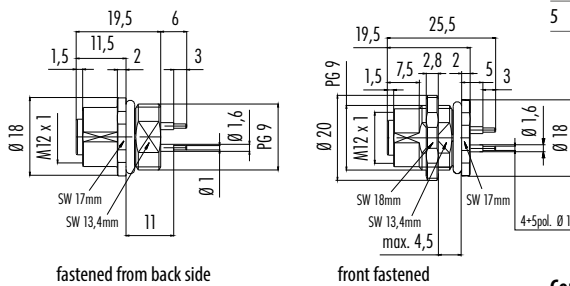

Contacts	Fix. thread	Fastened from back side	Front fastened
4	PG 9	–	86 0534 1000 00004
5	PG 9	86 0134 0000 00005	86 0534 1000 00005

Female panel mount connector, front fastened, dip-solder, with shielding sheet

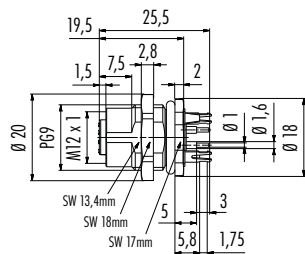

PCB thickness: 1,6 mm

Hexagonal nut enclosed loose

5	PG 9	86 0534 1120 00005
---	------	--------------------

Female receptacle for PCB assembly

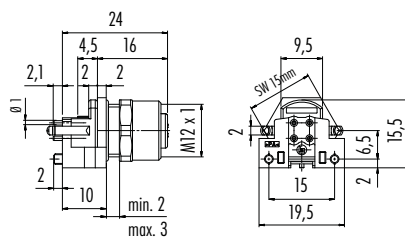

PCB thickness: 1,6 mm

View of mating side



5	99 4442 200 05
	99 4442 458 05 with shielding sheet

**Description**

Female angled receptacle for PCB assembly, for PCB mounting

**Drawing**

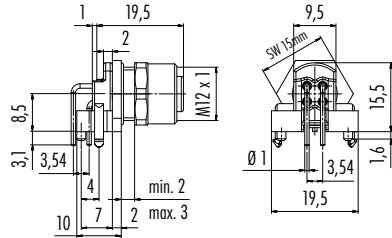

PCB thickness: 1,6 mm

View of mating side



**Contacts Ordering-No.**

5	99 4442 202 05	
	99 4442 601 05	with shielding sheet

Female receptacle, SMT, with housing, shieldable

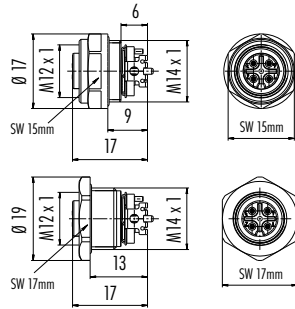

**Contacts Mounting height Ordering-No.**

4	9 mm	99 4432 401 04
	13 mm	99 4432 402 04
5	9 mm	99 4442 401 05
	13 mm	99 4442 402 05

Female receptacle, SMT, shieldable

4	-	09 0442 601 04
5	-	09 0444 601 05

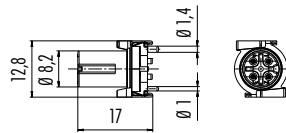

Female panel mount connector M16, with PROFIBUS-cable, shielded

<b>Contacts</b>	<b>Cable length, PUR</b>	<b>Fix. thread</b>	<b>Ordering-No.</b>
2 x 0,25	0,5 m	M16 x 1,5	70 4434 246 04

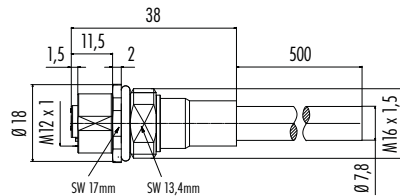

Female panel mount connector PG 9, front fastened, with PROFIBUS-cable, shielded

2 x 0,25	0,5 m	PG 9	70 4434 247 04
----------	-------	------	----------------

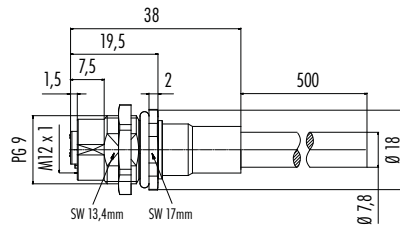

Hexagonal nut enclosed loose

**Contacts Ordering-No.**

4	09 5242 00 04
---	---------------

Adapter, lead-through for control cabinet, shielded

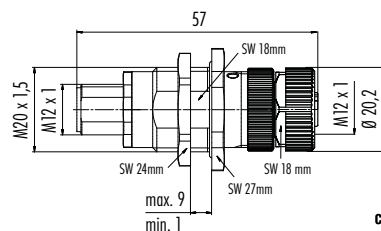

## Panel cut out

Panel mount connector

With flats as anti-rotation device

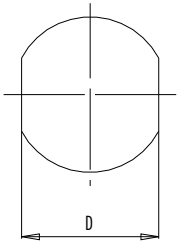

With bore hole

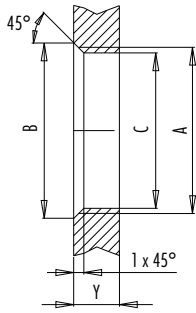

Installation direction:  
o-ring sits on chamfer.

Thread A	B (mm)	C (mm)	D (mm)
PG 9	16,2	15,3	13,5
PG 11	20,2	18,7	17,0
PG 13,5	21,5	20,5	—
M12 x 0,5	—	12,1	—
M12 x 1	—	12,2	—
M14 x 1	15,2	14,2	—
M16 x 1,5	17,0	16,1	13,5
M20 x 1,5	21,0	20,1	—

### Tightening moment

Metal housing	6,25 Nm
Positioning sleeve	6,25 Nm
Metal housing, screw clamp connection	5,00 Nm
Plastic housing	1,25 Nm
Positioning sleeve	1,25 Nm

Thickness of wall Y (mm)		
Version	min (mm)	max (mm)
Fastened from back side	2	3,5
Front fastened	2	4,5
Positioning possible <sup>1)</sup>	2	3,5
Screw clamp	2	3,5
Thread M12 x 1	2	3,0
Thread M14 x 1 <sup>2)</sup>	<sup>3)</sup> 1,5/ <sup>4)</sup> 2	6,5

### Notes

- <sup>1)</sup> Do not attach a chamfer
- <sup>2)</sup> Wall thickness:  
use locknut 01-5385 up to 1,5 mm  
>1,5 mm cut thread
- <sup>3)</sup> Nut
- <sup>4)</sup> Thread in wall of housing

Panel mount connector, square flange

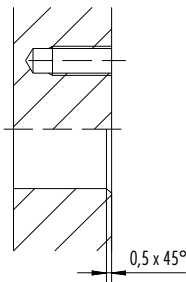
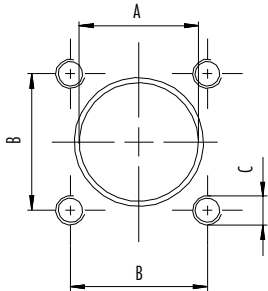

Housing A	B (mm)	C (mm)	D (mm)
Metal	12,2	14,0	M3 (4x)

### Requirements for Degree of protection IP67:

1. Metal housing: Use of sealing, Ordering-No. 16 0959 000
2. M3 thread (4x) sealed as a threaded blind holes or screw heads







- Screw locking acc. to DIN EN 61076-2-101 und 109
- Degree of protection IP67
- Moulded versions
- Easy Assembly
- Excellent EMC shielding
- Versions with shielding rings/cable clamp
- Angled connectors adjustable in 4 positions

### Description

### Drawing

### Contacts

### Cable outlet

### Ordering-No.

Male cable connector, CAT 5, screw clamp termination, with shielding ring, shieldable

4

6–8 mm

99 3729 810 04

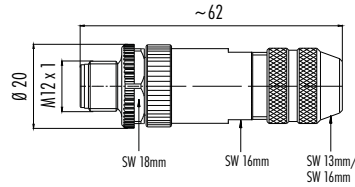

Male cable connector, CAT 5, screw clamp termination, iris type spring, shieldable

4

5–8 mm

99 3727 810 04

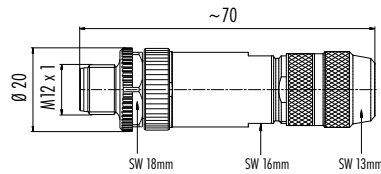

Male cable connector, CAT 5, screw clamp termination, with shielding ring, stainless steel version, shieldable

4

5,5–8,6 mm

99 3729 995 04

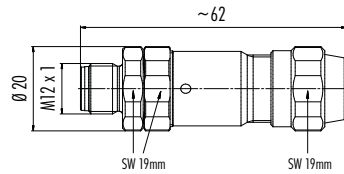

Male cable connector, CAT 5, crimp connection, shieldable

4

5–8 mm

99 3721 810 04

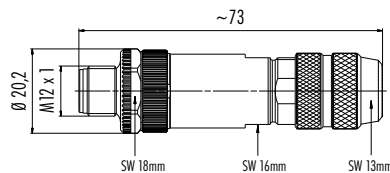

Crimp contacts see page 170

### Specifications

Contacts	4
Wire gauge	max. 0,75 mm <sup>2</sup> (max. AWG 20), see crimp contacts page 161, PROFINET 0,34 mm <sup>2</sup> (AWG 22)
Mechanical operation	> 100 Mating cycles
Temperature range	– 40 °C / + 85 °C, PROFINET – 25 °C / + 85 °C
Rated voltage	250 V
Pollution degree	3
Rated current (40°C)	4 A
Contact plating	Au (Gold)
Material of housing	zinc diecasting nickel plated, PUR

### Description

Male angled connector, CAT 5, screw clamp termination, with shielding ring, shieldable



### Drawing

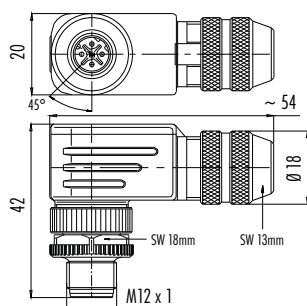

It is possible to turn and fix the contact carrier in 4 different 90° positions



### Contacts

### Cable outlet

### Ordering-No.

4	6-8 mm	99 3729 820 04
---	--------	----------------

Male angled connector, CAT 5, screw clamp termination, iris type spring, shieldable

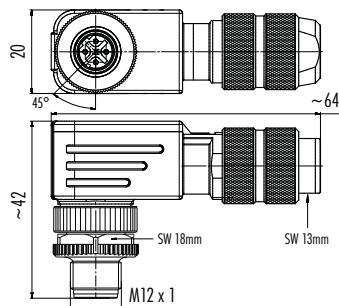

It is possible to turn and fix the contact carrier in 4 different 90° positions



4

5-8 mm

99 3727 820 04

Male angled connector, CAT 5, crimp connection, shieldable

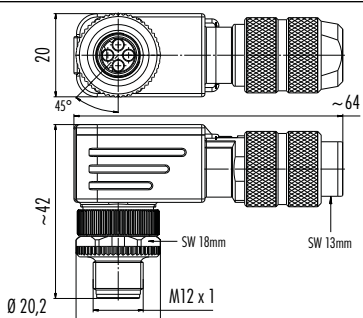

It is possible to turn and fix the contact carrier in 4 different 90° positions



4

5-8 mm

99 3721 820 04

Crimp contacts see page 170

Male cable connector, shielded, PROFINET

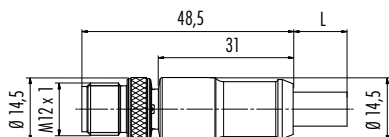

### Contacts

### Cable length

### Ordering-No.

4 x 0,34	2 m	77 4529 0000 50704-0200
	5 m	77 4529 0000 50704-0500
	10 m	77 4529 0000 50704-1000

### Specifications

### PROFINET Cable

Contacts	4
Wire gauge	2 x 2 x AWG 22
Material jacket	PUR
Insulation of wire	Polyolefin
Design of wire (mm)	7 x 0,34 (AWG 22)
Cable diameter (mm)	6,7
Resistance of wire	55 Ω/Km (20 °C)
Temperature range cable in move	- 20 °C / + 60 °C
Temperature range cable fixed	- 40 °C / + 80 °C
Bending radius cable in move	min. 15 x d
Bending radius cable fixed	min. 5 x d
Bending radius (at 10 x D)	2 Mio.
Permitted acceleration	2 m/s <sup>2</sup>
Traverse path horizontal 5 m/s <sup>2</sup>	5 m
Traverse path vertical 5 m/s <sup>2</sup>	5 m
Traverse speed	At 5 m horizontal traverse up to 200 m/min
Remark	In chain flex application or when stressed mechanically +60 °C.
Approval	PROFINET, UL/CSA
UL-style	AWM 20236

Description	Drawing	Contacts	Cable outlet	Ordering-No.
Female cable connector, CAT 5, screw clamp termination, with shielding ring, shieldable		4	6–8 mm	99 3730 810 04



Female cable connector, CAT 5, screw clamp termination, iris type spring, shieldable		4	5–8 mm	99 3728 810 04
--	--	---	--------	----------------



Female angled connector, CAT 5, screw clamp termination, with shielding ring, shieldable		4	5,5–8,6 mm	99 3730 820 04
--	--	---	------------	----------------



It is possible to turn and fix the contact carrier in 4 different 90° positions



Female angled connector, CAT 5, screw clamp termination, iris type spring, shieldable		4	5–8 mm	99 3728 820 04
---	--	---	--------	----------------



It is possible to turn and fix the contact carrier in 4 different 90° positions



Female cable connector, shielded, PROFINET		Contacts	Cable length	Ordering-No.
		4 x 0,34	2 m	77 4530 0000 50704–0200
			5 m	77 4530 0000 50704–0500
		10 m	77 4530 0000 50704–1000	



Single contact (Male), PU 100 pieces		Wire gauge	AWG	Ordering-No.
		0,14 mm <sup>2</sup> – 0,34 mm <sup>2</sup>	26–22	61 1224 146
		0,34 mm <sup>2</sup> – 0,5 mm <sup>2</sup>	22–20	61 1154 146
		0,75 mm <sup>2</sup> – 1,0 mm <sup>2</sup>	18–16	61 1225 146
		1,0 mm <sup>2</sup> – 1,5 mm <sup>2</sup>	16	61 1226 146



## Component part drawing

Cable connectors, with shielding ring, shieldable

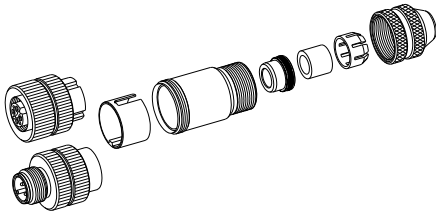

- Female insert/ Male insert
- Insulating sleeve tightly built into coupling sleeve
- Shielding ring
- O-ring
- Seal
- Pinch ring
- Pressing screw

Cable connectors, with iris type spring, shieldable

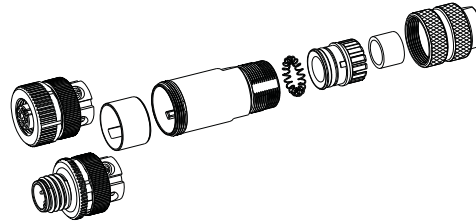

- Female insert/ Male insert
- Insulating sleeve, Sleeve, Pressing spring, O-ring, Pinch ring, Seal, Pressing screw are premounted

Angled connectors, shieldable

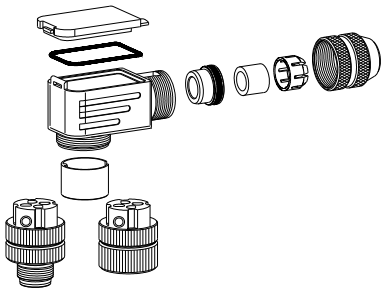

- Female insert/ Male insert
- Insulating sleeve tightly built into coupling sleeve
- Housing
- Seal
- Cover
- Shielding ring
- O-ring
- Seal
- Pinch ring
- Pressing screw

Angled connectors, with iris type spring, shieldable

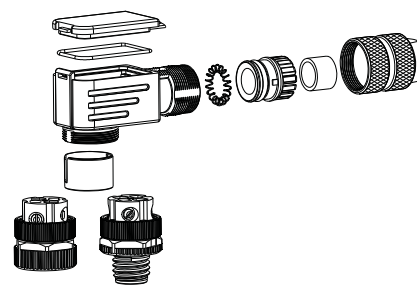

- Female insert/ Male insert
- Insulating sleeve, Housing, Pressing spring, O-ring, Pinch ring, Seal, Pressing screw are premounted
- O-ring
- Cover

## Contact arrangements male insert (mating side)

4 contacts

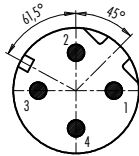

## Contact arrangements female insert (mating side)

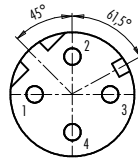

## Colour of wire, moulded cable and panel mount connectors

- 1 white-orange
  - 2 orange
  - 3 white-green
  - 4 green
- Shield = Coupling ring

**Description**

Male receptacle for PCB assembly



**Drawing**

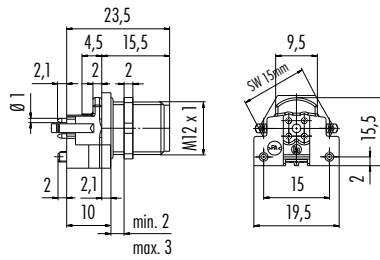

PCB thickness: 1,6 mm

View of mating side



**Contacts Ordering-No.**

4	99 3731 200 04
	99 3731 201 04 with shielding sheet

Male angled receptacle for PCB assembly

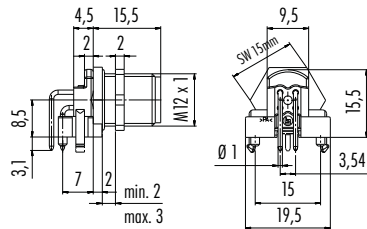

PCB thickness: 1,6 mm

View of mating side



**Contacts Ordering-No.**

4	99 3731 202 04
	99 3731 203 04 with shielding sheet

Male receptacle, SMT, with housing, shieldable

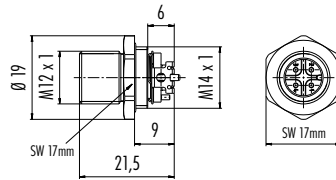

**Contacts Mounting height Ordering-No.**

4	9 mm	99 3731 401 04
---	------	----------------

Male receptacle, SMT, shieldable

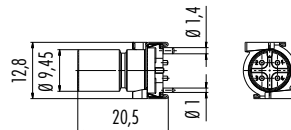

**Contacts Mounting height Ordering-No.**

4	-	09 0731 601 04
---	---	----------------

Male panel mount connector M16, with PROFINET-cable, shielded

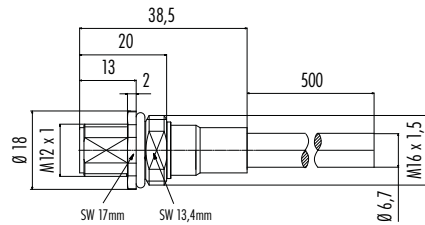

**Contacts Cable length, PUR Fix. thread Ordering-No.**

4	0,5 m	M16 x 1,5	70 3733 705 04
---	-------	-----------	----------------



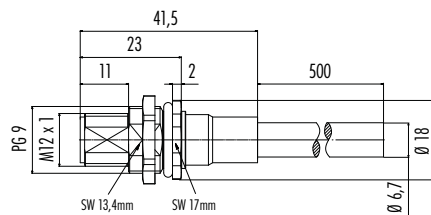





Male panel mount connector PG 9, front fastened, with PROFINET-cable, shielded

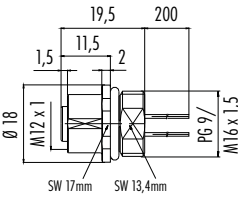
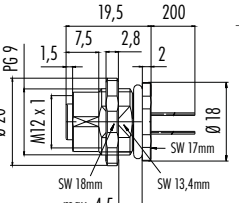

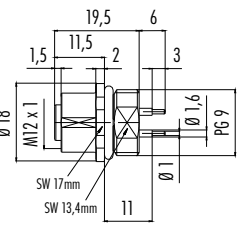
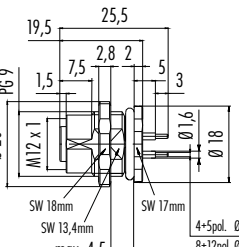
Hexagonal nut enclosed loose

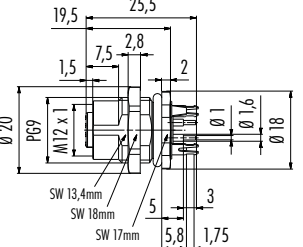
**Contacts Cable length, PUR Fix. thread Ordering-No.**

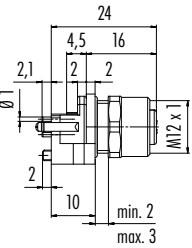
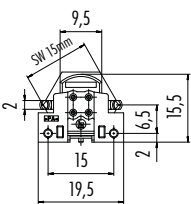
4	0,5 m	PG 9	70 3733 706 04
---	-------	------	----------------

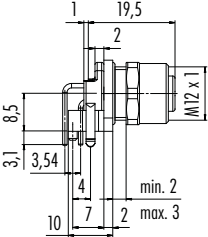
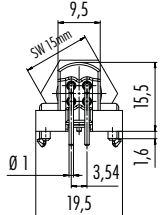
Description	Drawing	Contacts	Fix. thread	Fastened from back side	Front fastened
Female panel mount connector with single wires	 <div style="display: flex; justify-content: space-around;"> <div style="text-align: center;">  <p>fastened from back side</p> </div> <div style="text-align: center;">  <p>front fastened</p> </div> </div>	4	PG 9 M16 x 1,5	76 0136 0011 00404-0200 76 0236 0011 00404-0200	76 0536 1011 00404-0200 -
Female panel mount connector, dip-solder	 <div style="display: flex; justify-content: space-around;"> <div style="text-align: center;">  <p>fastened from back side</p> </div> <div style="text-align: center;">  <p>front fastened</p> </div> </div>	4	PG 9	86 0136 0000 00404	86 0536 1000 00404
Female panel mount connector, front fastened, dip-solder, with shielding sheet	 <div style="text-align: center;">  <p>PCB thickness: 1,6 mm      Hexagonal nut enclosed loose</p> </div>	4	PG 9	86 0536 1120 00404	
Female receptacle for PCB assembly	 <div style="display: flex; justify-content: space-around;"> <div style="text-align: center;">  <p>PCB thickness: 1,6 mm</p> </div> <div style="text-align: center;">  <p>View of mating side</p> </div> </div>	4	99 3732 200 04 99 3732 201 04	with shielding sheet	
Female angled receptacle for PCB assembly, for PCB assembly	 <div style="display: flex; justify-content: space-around;"> <div style="text-align: center;">  <p>PCB thickness: 1,6 mm</p> </div> <div style="text-align: center;">  <p>View of mating side</p> </div> </div>	4	99 3732 202 04 99 3732 203 04	with shielding sheet	
<b>Specifications</b>	<b>Panel mount connector</b>				
Contacts		4			
Wire gauge		max. 0,25 mm <sup>2</sup> (max. AWG 24), AWG 22			
Mechanical operation		> 100 Mating cycles			
Temperature range		- 40 °C / + 85 °C			
Rated voltage		250 V			
Pollution degree		3			
Rated current (40°C)		4 A			
Contact plating		Au (Gold)			
Material of housing		CuZn (brass nickel plated), zinc diecasting nickel plated			

<sup>1)</sup> Standard wire length is 200 mm for 76-order-numbers. Other lengths upon request.





## Panel cut out

### Panel mount connector

With flats as anti-rotation device

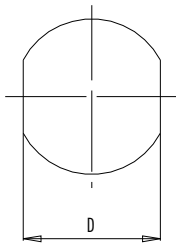

With bore hole

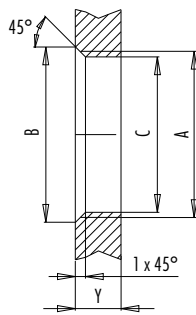

Installation direction:  
o-ring sits on chamfer.

Thread A	B (mm)	C (mm)	D (mm)
PG 9	16,2	15,3	13,5
PG 11	20,2	18,7	17,0
PG 13,5	21,5	20,5	—
M12 x 0,5	—	12,1	—
M12 x 1	—	12,2	—
M14 x 1	15,2	14,2	—
M16 x 1,5	17,0	16,1	13,5
M20 x 1,5	21,0	20,1	—

### Tightening moment

Metal housing	6,25 Nm
Positioning sleeve	6,25 Nm
Metal housing, screw clamp connection	5,00 Nm
Plastic housing	1,25 Nm
Positioning sleeve	1,25 Nm

Thickness of wall Y (mm)		
Version	min (mm)	max (mm)
Fastened from back side	2	3,5
Front fastened	2	4,5
Positioning possible <sup>1)</sup>	2	3,5
Screw clamp	2	3,5
Thread M12 x 1	2	3,0
Thread M14 x 1 <sup>2)</sup>	<sup>3)</sup> 1,5/ <sup>4)</sup> 2	6,5

### Notes

- <sup>1)</sup> Do not attach a chamfer
- <sup>2)</sup> Wall thickness:  
use locknut 01-5385 up to 1,5 mm  
>1,5 mm cut thread
- <sup>3)</sup> Nut
- <sup>4)</sup> Thread in wall of housing

### Panel mount connector, square flange

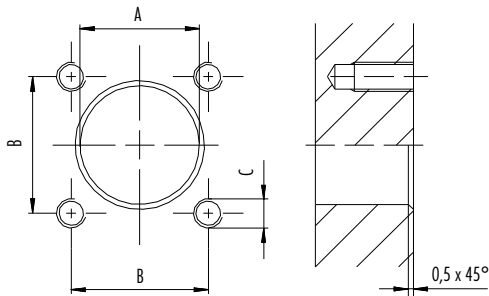

Housing A	B (mm)	C (mm)	D (mm)
Metal	12,2	14,0	M3 (4x)

### Requirements for Degree of protection IP67:

1. Metal housing: Use of sealing, Ordering-No. 16 0959 000
2. M3 thread (4x) sealed as a threaded blind holes or screw heads

- Connector for Ethernet
- Versions for assembly
- Moulded versions IP67
- Excellent EMC shielding



**Description**

Male cable connector, IDT connection, shieldable, IP67

**Drawing**

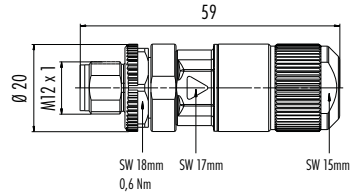

Contacts	Cable outlet	Ordering-No.
8	5,5–9 mm	99 3787 810 08



RJ45-male connector, shieldable, IP20

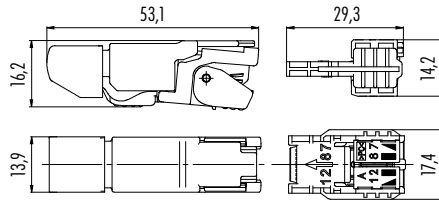
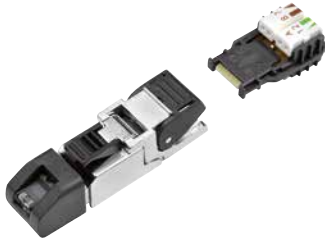

Contacts	T568	Cable outlet	Wire gauge	Ordering-No.
4		Profinet	AWG 24–22/1 AWG 27–22/7	99 9647 810 04
8	A	5–9 mm	AWG 26–24/1 AWG 27–24/7	99 9687 805 08
			AWG 24–22/1 AWG 27–22/7	99 9687 810 08
8	B		AWG 26–24/1 AWG 27–24/7	99 9687 809 08
			AWG 24–22/1 AWG 27–22/7	99 9687 814 08



Connecting cable, 2 male cable connectors M12 x 1, shielded, IP67

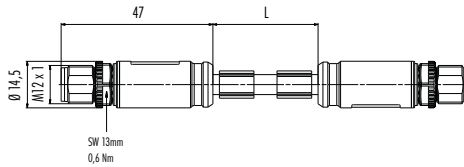

Contacts	Cable length, PUR	Ordering-No.
8	2 m	79 9722 020 08
	5 m	79 9722 050 08
	10 m	79 9722 100 08

Connecting cable, Male cable connector M12 x 1 – Female cable connector, M12 x 1, shielded

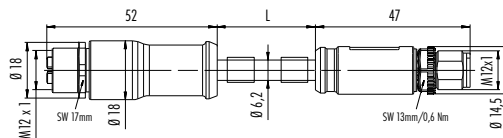

8	2 m	79 9724 020 08
	5 m	79 9724 050 08
	10 m	79 9724 100 08



**Specifications**

Contacts	8 Male cable connector	4, 8 RJ45	8 Connecting cable
Wire gauge	AWG 27 – AWG 22		AWG 26/7
Mechanical operation	> 100 Mating cycles	> 750 Mating cycles	> 100 Mating cycles
Temperature range	– 40 °C / + 85 °C		
Rated voltage	50 V AC, 60 V DC	50 V DC	50 V AC, 60 V DC
Pollution degree	3	2	3
Rated current (40°C)	0,5 A	1 A	0,5 A
Contact plating	Au (Gold)		
Material of housing	CuZn (brass nickel plated), zinc diecasting nickel plated	zinc diecasting nickel plated	PUR

Connecting cable, male cable connector M12 x 1 – RJ45-male connector, shielded, IP67

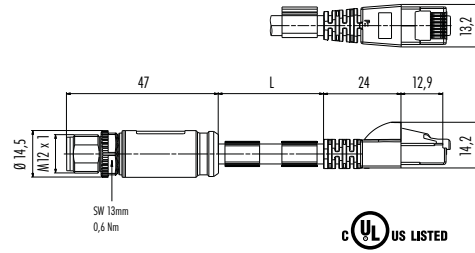

Contacts	Cable length, PUR	Ordering-No.
8	2 m	79 9723 020 08
	5 m	79 9723 050 08
	10 m	79 9723 100 08

Female panel mount connector, dip-solder

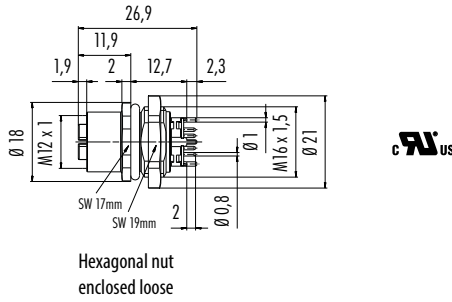

Contacts	Fixing thread	Ordering-No.
8	M16 x 1,5	09 3782 95 08

Female panel mount connector, front fastened, dip-solder

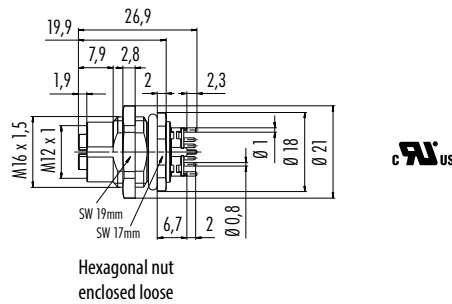

8	M16 x 1,5	09 3782 91 08
---	-----------	---------------

Female panel mount connector, dip-solder, contact carrier fix/flexible mounting via undular washer

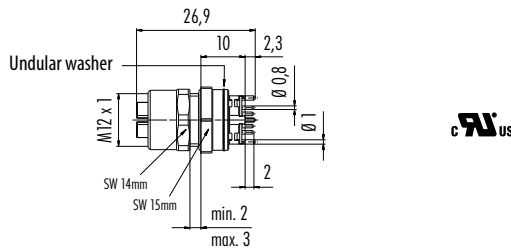

Contacts	Fix. thread	Contact carrier	Ordering-No.
8	M16 x 1,5	fix	99 3782 210 08
		via undular washer	99 3782 200 08

Female angled panel mount connector, dip solder, contact carrier fix/flexible mounting via undular washer

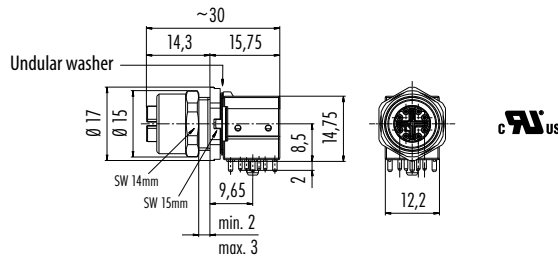

8	M16 x 1,5	fix	99 3782 213 08
		via undular washer	99 3782 202 08

Female panel mount connector, front fastened, with Ethernet cable

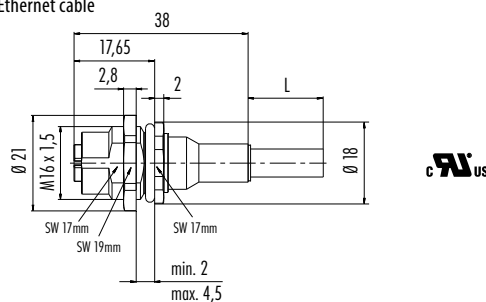

Contacts	Fix. thread	Cable length	Ordering-No.
8	M16 x 1,5	0,5 m	70 3784 706 08

Description	Drawing	Contacts	Fixing thread	Ordering-No.
Contact insert, dip-solder, for mounting in customer housing		8	M16 x 1,5	09 3782 95 08



O-ring enclosed  
loose



Contact insert, angled, dip solder, for mounting in customer housing		8	09 3782 202 08	
--	--	---	----------------	--

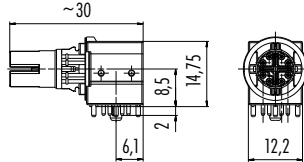

Adapter, lead through for control cabinet, female-female, shielded		8	09 5286 00 08	
--	--	---	---------------	--

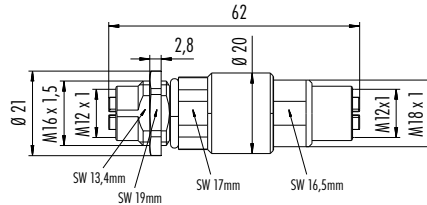

### Contact arrangement male insert (mating side)

4 contacts

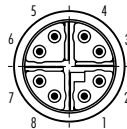

### Contact arrangement female insert (mating side)

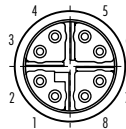

### Colour of wire, moulded cable and panel mount connectors

- 1 white-orange
- 2 orange
- 3 white-green
- 4 green
- 5 white-brown
- 6 brown
- 7 white-blue
- 8 blue

Shield on housing

### Panel cut out

Panel mount connector

With flats as anti-rotation device

With bore hole

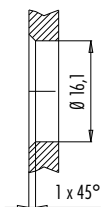
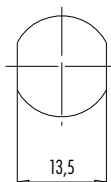

Tightening torque  
Metal housing 6,25 Nm  
Plastic housing 3,75 Nm

Panel mount connector, two halves

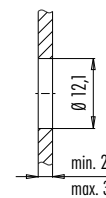

Tightening torque  
M12 x 1,5 6,25 Nm

Panel mount connector, front fastened

With flats as anti-rotation device

With bore hole

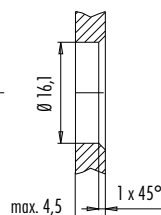
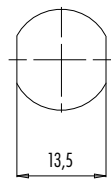

Tightening torque  
Metal housing 6,25 Nm  
Plastic housing 3,75 Nm





- Screw locking acc. to DIN EN 61076-2-111
- Degree of protection IP67
- Easy assembly
- Power supply up to 630 V AC/12 A
- Angled connectors adjustable in 4 positions
- Panel mount connector with single wires/screw clamp contacts

### Description

Male cable connector, for power supply

### Drawing

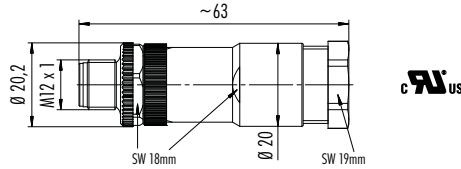

### Contacts

2+PE  
3+PE

### Cable outlet

8–10 mm

### Ordering-No.

99 0685 19 03  
99 0689 19 04



Male cable connector, K-Coding, screw clamp termination, Power

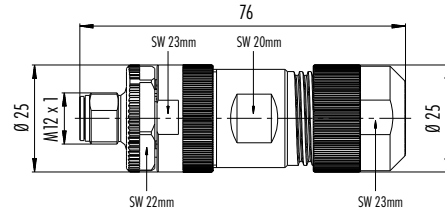

4+PE

8–13 mm

99 0699 29 05

Male angled connector, for power supply

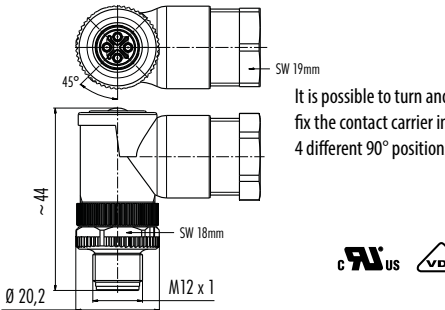

3+PE

8–10 mm

99 0689 58 04

Male cable connector, for power supply, moulded, PUR (black)

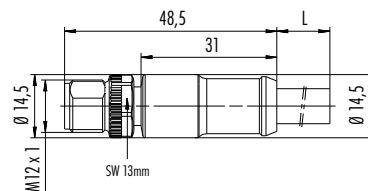

### Contacts

3+PE

### Cable length, PUR

2 m  
5 m

### Ordering-No.

77 0689 0000 50704-0200  
77 0689 0000 50704-0500

### Specifications

Contacts	2+PE	3+PE	4+PE
Wire gauge	M12-S: max. 2,5 mm <sup>2</sup> (max. AWG 14)	M12-S: max. 1,5 mm <sup>2</sup> (max. AWG 16)	M12-K: max. 2,5 mm <sup>2</sup> (max. AWG 14)
Mechanical operation	> 100 Mating cycles		
Temperature range	- 40 °C / + 85 °C		
Rated voltage	630 V		
Pollution degree	3		
Rated current (40°C)	16 A		12 A
Contact plating	Au (Gold)		
Material of housing	PA		

# M12 S-/K-Coding

For Power Supply AC 630 V

Automation Technology 814 series

## Description

Female cable connector, for power supply

## Drawing

## Contacts

## Cable outlet

## Ordering-No.

2+PE

8–10 mm

99 0686 19 03

3+PE

99 0690 19 04

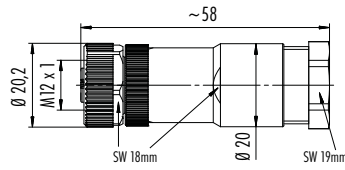

Female cable connector, K-Coding, screw clamp termination, Power

4+PE

8–13 mm

99 0700 29 05

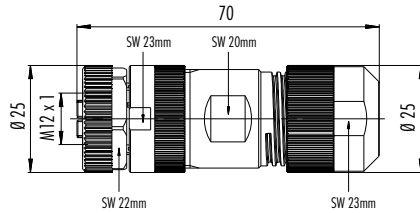

Female angled connector, for power supply

3+PE

8–10 mm

99 0690 58 04

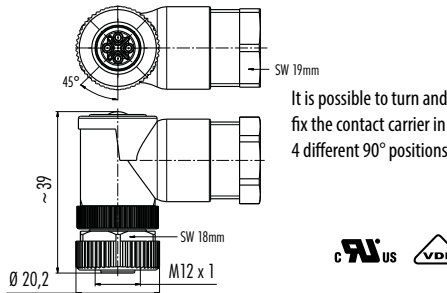

Female cable connector, for power supply, moulded, PUR (black)

## Contacts

## Cable length, PUR

## Ordering-No.

3+PE

2 m

77 0690 0000 50704-0200

5 m

77 0690 0000 50704-0500

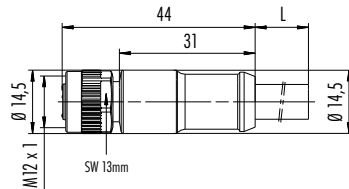

## Component part drawing

Cable connectors

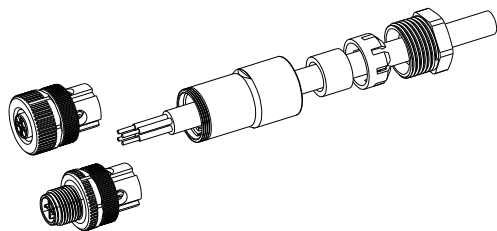

Female insert/  
Male insert  
Sleeve  
Seal  
Pinch ring  
Pressing screw

Angled connectors

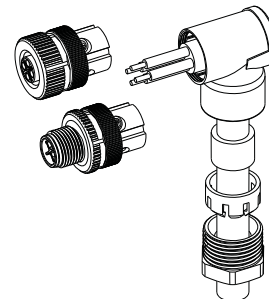

Female insert/  
Male insert  
Angled housing  
Seal  
Pinch ring  
Pressing screw



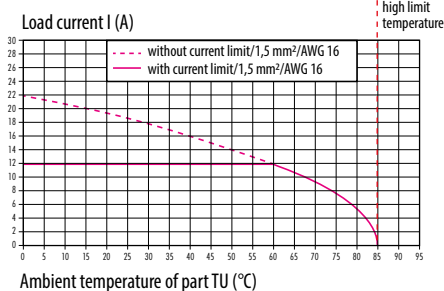

## Rating

Derating curve according to DIN EN 60512 for POWER cable connectors S-Coding 3+PE contacts

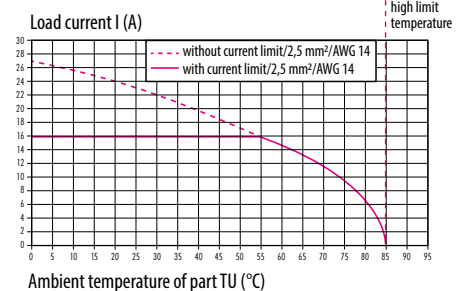

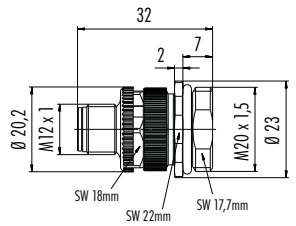
Derating curve according to DIN EN 60512 for POWER cable connectors K-Coding 4+PE contacts

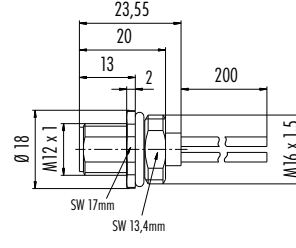

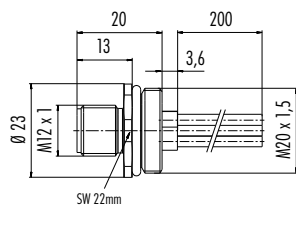
Description	Drawing	Contacts	Fixing thread	Ordering-No.
Male panel mount connector, screw clamp termination		3+PE	M20 x 1,5	99 0693 500 04
Male panel mount connector, with single wires, plastic housing		3+PE x AWG 16	M16 x 1,5	09 0691 300 04
Male panel mount connector, front fastened, with single wires, plastic housing		3+PE x AWG 16	M16 x 1,5	09 0691 320 04
Male panel mount connector, with single wires		2+PE x AWG 16 3+PE x AWG 16	M16 x 1,5	09 0687 700 03 09 0691 700 04
Male panel mount connector, rectangular flange, with single wires		3+PE x AWG 16	M16 x 1,5	09 0691 121 04
Male panel mount connector, with single wires, M20 x 1,5		3+PE x AWG 16	M20 x 1,5	09 0691 642 04



**Description**

**Drawing**

**Contacts**

**Fixing thread**

**Ordering-No.**

Male panel mount connector, rectangular flange, with single wires, metal housing, IP40 without sealing, IP67 with sealing (16 0959 000)

3+PE x AWG 16

–

09 0691 070 04

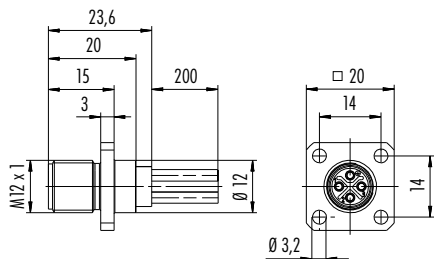

**Component part drawing**

Panel mount connector, screw clamp termination, not shieldable

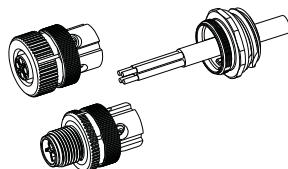

**Contact arrangements male insert (mating side)**

2+PE contacts

3+PE contacts

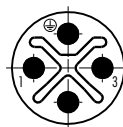
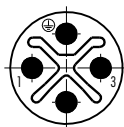

**Contact arrangements female insert (mating side)**

**Colour of wire**

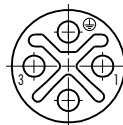

2+PE contacts		3+PE contacts	
1	black 1	1	black 1
2	not connected	2	black 2
3	black 3	3	black 3
⊕	yellow/green	⊕	yellow/green

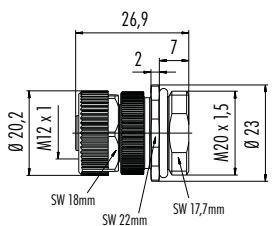
Description	Drawing	Contacts	Fixing thread	Ordering-No.
Female panel mount connector, screw clamp termination		3+PE	M20 x 1,5	99 0694 500 04

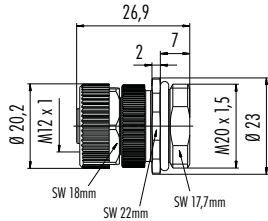

Female panel mount connector, with single wires, plastic housing		3+PE x AWG 16	M16 x 1,5	09 0692 300 04
--	--	---------------	-----------	----------------

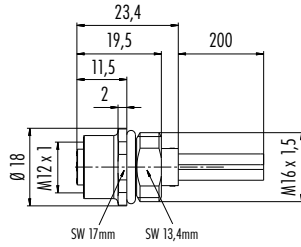

Female panel mount connector, front fastened, with single wires, plastic housing		3+PE x AWG 16	M16 x 1,5	09 0692 321 04
--	--	---------------	-----------	----------------

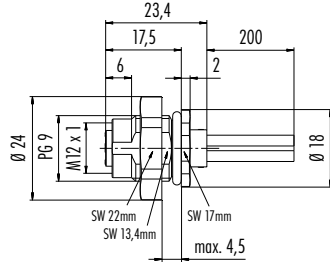

Female panel mount connector, with single wires		2+PE x AWG 16 3+PE x AWG 16	M16 x 1,5	09 0688 700 03 09 0692 700 04
---	--	--------------------------------	-----------	----------------------------------

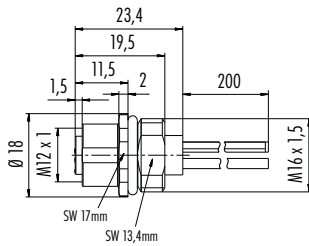

Female panel mount connector, front fastened, with single wires		3+PE x AWG 16	M16 x 1,5	09 0692 121 04
---	--	---------------	-----------	----------------

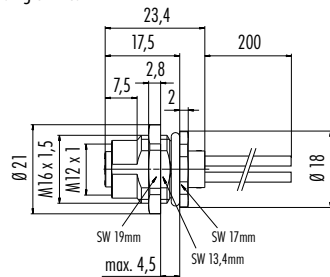

Female panel mount connector, with single wires, M20 x 1,5		3+PE x AWG 16	M20 x 1,5	09 0692 642 04
--	--	---------------	-----------	----------------

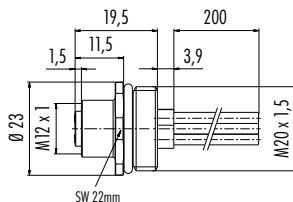

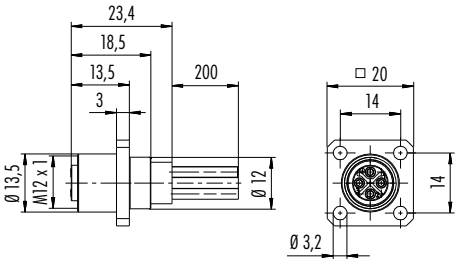
Description	Drawing	Contacts	Fixing thread	Ordering-No.
Female panel mount connector, rectangular flange, with single wires, metal housing, IP40 without sealing, IP67 with sealing (16 0959 000)		3+PE x AWG 16	–	09 0692 070 04

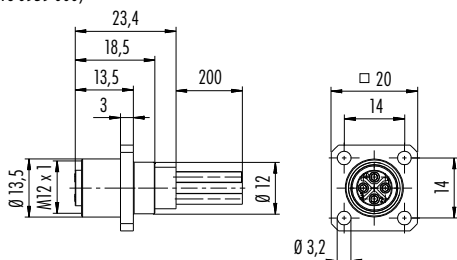

### Panel cut out

Panel mount connector

With flats as anti-rotation device

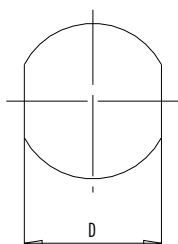

With bore hole

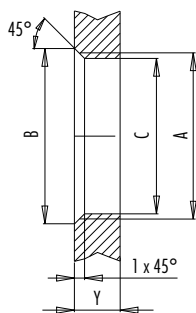

Installation direction:  
o-ring sits on chamfer.

Thread A	B (mm)	C (mm)	D (mm)
PG 9	16,2	15,3	13,5
PG 11	20,2	18,7	17,0
PG 13,5	21,5	20,5	—
M12 x 0,5	—	12,1	—
M12 x 1	—	12,2	—
M14 x 1	15,2	14,2	—
M16 x 1,5	17,0	16,1	13,5
M20 x 1,5	21,0	20,1	—

### Tightening moment

Metal housing	6,25 Nm
Positioning sleeve	6,25 Nm
Metal housing, screw clamp connection	5,00 Nm
Plastic housing	1,25 Nm
Positioning sleeve	1,25 Nm

Thickness of wall Y (mm)		
Version	min (mm)	max (mm)
Fastened from back side	2	3,5
Front fastened	2	4,5
Positioning possible <sup>1)</sup>	2	3,5
Screw clamp	2	3,5
Thread M12 x 1	2	3,0
Thread M14 x 1 <sup>2)</sup>	<sup>3)</sup> 1,5/ <sup>4)</sup> 2	6,5

### Notes

- <sup>1)</sup> Do not attach a chamfer
- <sup>2)</sup> Wall thickness:  
use locknut 01-5385 up to 1,5 mm  
>1,5 mm cut thread
- <sup>3)</sup> Nut
- <sup>4)</sup> Thread in wall of housing

Panel mount connector, square flange

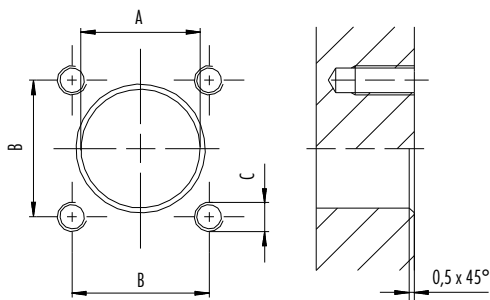

Housing A	B (mm)	C (mm)	D (mm)
Metal	12,2	14,0	M3 (4x)
Plastic	20,0	20,0	M3 (4x)

### Requirements for Degree of protection IP67:

1. Metal housing: Use of sealing, Ordering-No. 16 0959 000
2. Plastic housing: Use of sealing, Ordering-No. 16 8091 000
3. M3 thread (4x) sealed as a threaded blind holes or screw heads



- Screw locking acc. to DIN EN 61076-2-111
- Degree of protection IP67
- Easy assembly
- Power supply up to 63 V DC/12 A
- Angled connectors adjustable in 4 positions
- Panel mount connector with single wires/dip-solder/screw clamp contacts

Description	Drawing	Contacts	Cable outlet	Ordering-No.
Male cable connector, for power supply		4	8–10 mm	99 0629 19 04

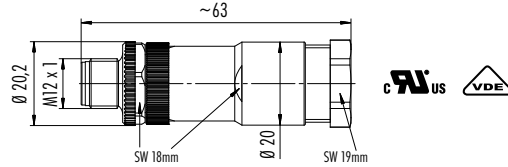

Male cable connector, L-Coding, screw clamp termination, Power		4+FE	8–13 mm	99 0639 29 05
--	--	------	---------	---------------

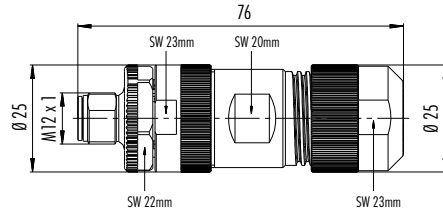

Male cable connector, for power supply, iris type spring, shieldable		4	5–8 mm	99 1631 814 04
			8–9 mm	99 1631 812 04

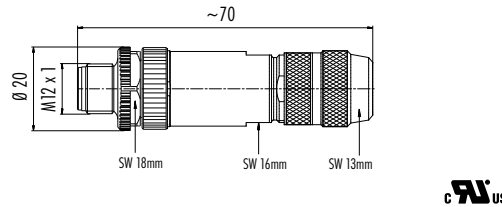

Male angled connector, for power supply		4	8–10 mm	99 0629 58 04
---	--	---	---------	---------------

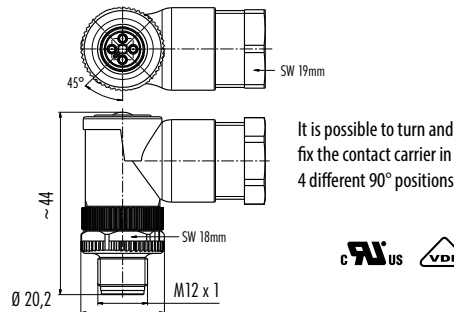

Specifications				
Contacts	4		4+FE	
Wire gauge	M12-T: max. 1,5 mm <sup>2</sup> (max. AWG 16)		M12-L: max. 2,5 mm <sup>2</sup> (max. AWG 14)	
Mechanical operation	> 100 Mating cycles			
Temperature range	– 40 °C / + 85 °C			
Rated voltage	63 V			
Pollution degree	3			
Rated current (40°C)	M12-T: 12 A		M12-L: 16 A	
Contact plating	Au (Gold)			
Material of housing	PA			

Description	Drawing	Contacts	Cable length, PUR	Ordering-No.
Male cable connector, for power supply, moulded, PUR (black)		4	2 m	77 0629 0000 50704-0200
			5 m	77 0629 0000 50704-0500

### Component part drawing

Cable connectors, not shieldable

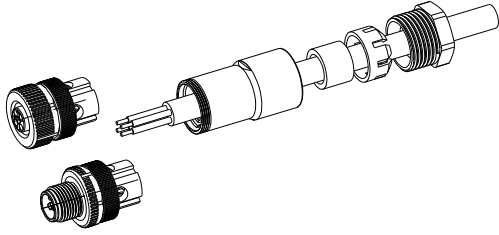

Female insert/  
Male insert  
Sleeve/  
Seal  
Pinch ring  
Pressing screw

Cable connectors, iris type spring, shieldable

shield-diameter  
>5,5 mm

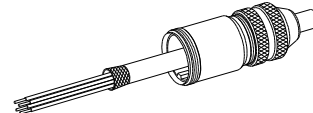
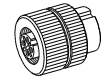

Female insert/  
Male insert  
Sleeve  
Seal  
Pinch ring  
Pressing screw:  
screw down with  
≥100 cNm

shield-diameter  
≤5,5 mm

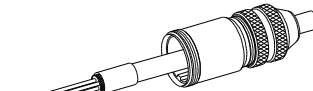
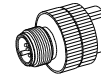

wrap shielding braid with copper tape  
and revert to cable jacket

Angled connectors, not shieldable

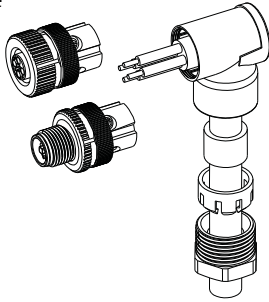

Female insert/  
Male insert  
Angled housing  
Seal  
Pinch ring  
Pressing screw

### Rating

Derating curve  
according to DIN EN 60512 for  
POWER cable connectors  
T-Coding 4 contacts

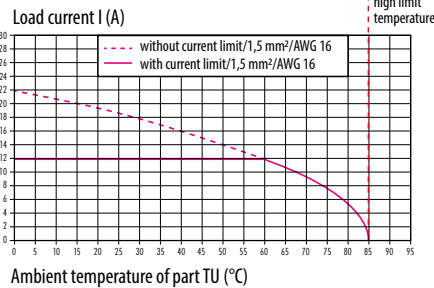

Derating curve  
according to DIN EN 60512 for  
POWER cable connectors  
L-Coding 4+FE contacts

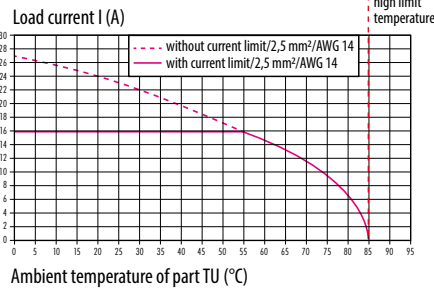

Description	Drawing	Contacts	Cable outlet	Ordering-No.
Female cable connector, for power supply		4	8–10 mm	99 0630 19 04

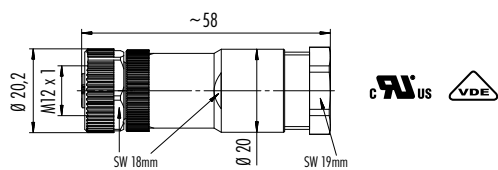

Female cable connector, L-Coding, screw clamp termination, Power		4+FE	8–13 mm	99 0640 29 05
--	--	------	---------	---------------

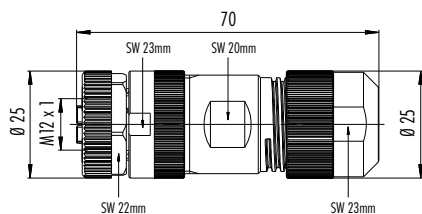

Female cable connector, for power supply, iris type spring, shieldable		4	5–8 mm	99 1632 814 04
			8–9 mm	99 1632 812 04

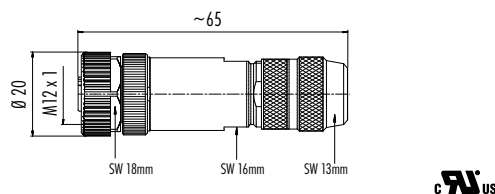



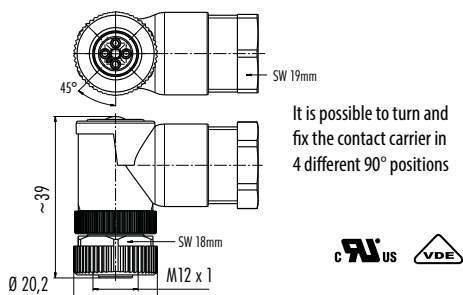



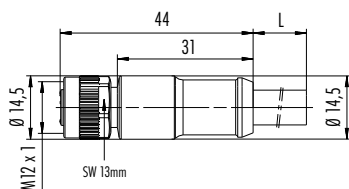

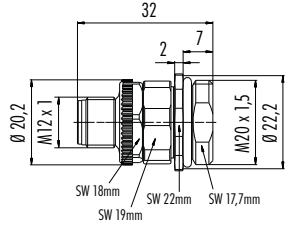

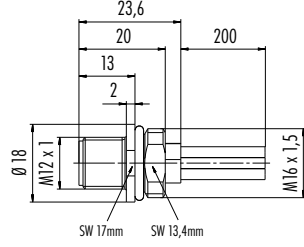
Female angled connector, for power supply		4	8–10 mm	99 0630 58 04
---	--	---	---------	---------------

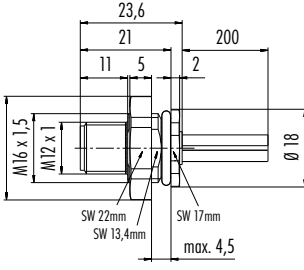

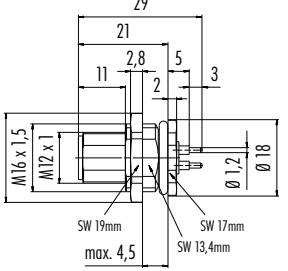
Female cable connector, for power supply, moulded, PUR (black)	Contacts	Cable length, PUR	Ordering-No.
		4	
		5 m	77 0630 0000 50704-0500

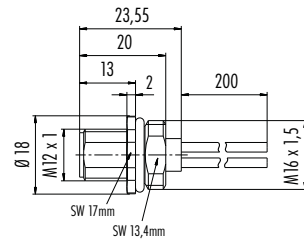

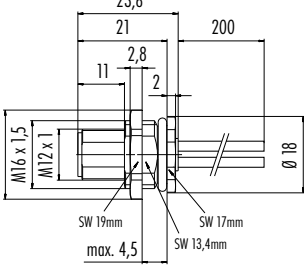
Description	Drawing	Contacts	Fixing thread	Ordering-No.
<p>Male panel mount connector, screw clamp termination</p> 		4	M20 x 1,5	99 0633 500 04
<p>Male panel mount connector with single wires, plastic housing</p> 		4	M16 x 1,5	09 0631 300 04
<p>Male panel mount connector, front fastened, with single wires, plastic housing</p> 		4	M16 x 1,5	09 0631 320 04
<p>Male panel mount connector, front fastened, dip-solder</p> 		4	M16 x 1,5	09 0631 90 04
<p>Male panel mount connector, with single wires</p> 		4 x AWG 16	M16 x 1,5	09 0631 700 04
<p>Male panel mount connector, front fastened, with single wires</p> 		4 x AWG 16	M16 x 1,5	09 0631 120 04

Description	Drawing	Contacts	Fixing thread	Ordering-No.
Male panel mount connector, with single wires, M20 x 1,5		4 x AWG 16	M20 x 1,5	09 0631 642 04

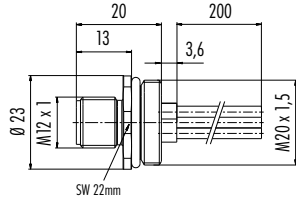

Male panel mount connector, rectangular flange, with single wires, metal housing, IP40 without sealing, IP67 with sealing (16 0959 000)

4 x AWG 16	–	09 0631 070 04
------------	---	----------------

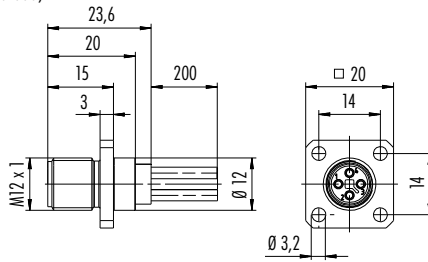

### Component part drawing

Panel mount connector, screw clamp termination, not shieldable

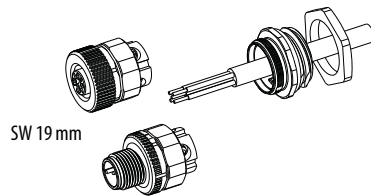

Wire cross section  
max. 1,5 mm<sup>2</sup>      4 contacts

Contact insert  
4 x 90° adjustable

Tightening torque  
SW 19 Nut = 5 Nm      M18 x 0,75  
M20 x 1,5 = 5 Nm

### Contact arrangements male insert (mating side)

4 contacts

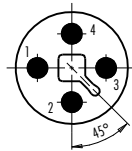

### Contact arrangements female insert (mating side)

#### Colour of wire

- 1 brown
- 2 white
- 3 blue
- 4 black

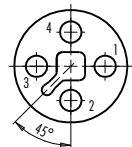

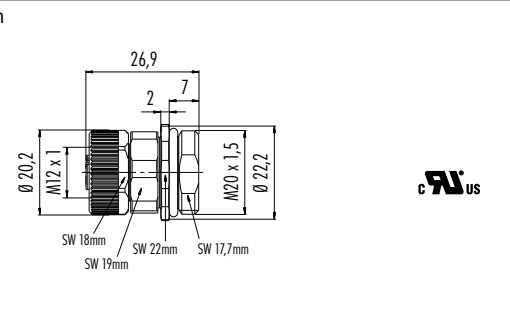
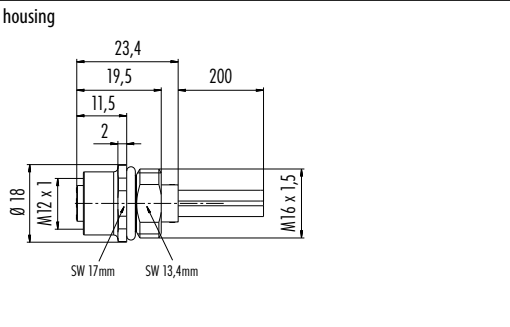
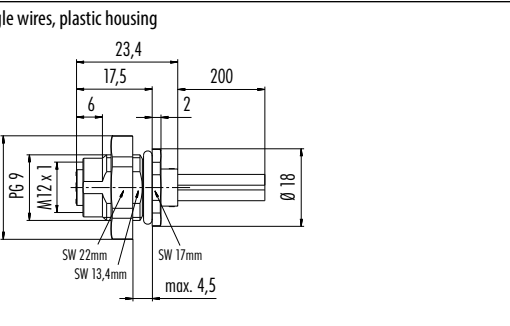
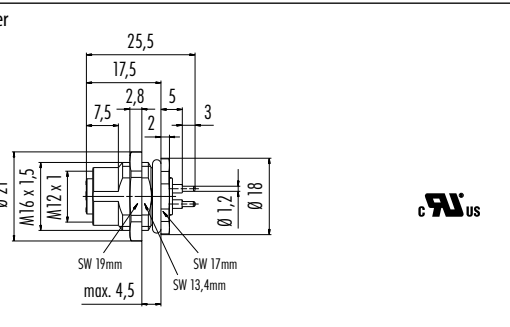
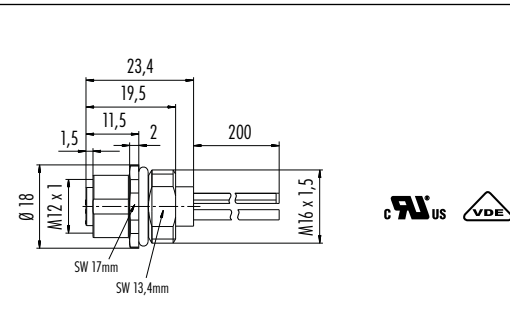
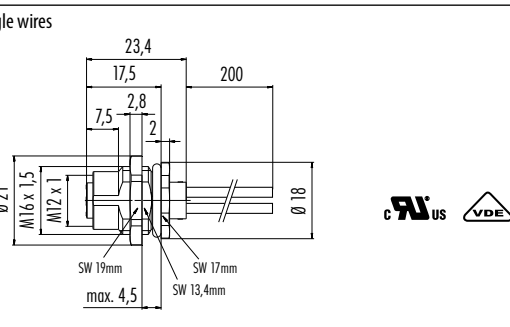

Description	Drawing	Contacts	Fixing thread	Ordering-No.
Female panel mount connector, screw clamp termination		4	M20 x 1,5	99 0634 500 04
Female panel mount connector with single wires, plastic housing		4 x AWG 16	M16 x 1,5	09 0632 300 04
Female panel mount connector, front fastened, with single wires, plastic housing		4 x AWG 16	M16 x 1,5	09 0632 321 04
Female panel mount connector, front fastened, dip-solder		4	M16 x 1,5	09 0632 90 04
Female panel mount connector, with single wires		4 x AWG 16	M16 x 1,5	09 0632 700 04
Female panel mount connector, front fastened, with single wires		4 x AWG 16	M16 x 1,5	09 0632 120 04







- Screw locking 7/8"
- Degree of protection IP67
- Moulded versions IP68
- Easy assembly
- Angled connectors adjustable in 8 positions
- Panel mount connector with single wires/dip-solder contacts

**Description**

Male cable connector, moulded

**Drawing**

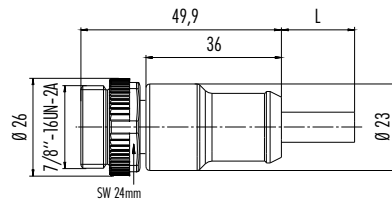

**Contacts**

**Cable length, PUR**

**Ordering-No.**

3 x 1,5	2 m	77 1429 0000 50003-0200
	5 m	77 1429 0000 50003-0500
	10 m	77 1429 0000 50003-1000
4 x 1,5	2 m	77 1429 0000 50004-0200
	5 m	77 1429 0000 50004-0500
	10 m	77 1429 0000 50004-1000
5 x 1,5	2 m	77 1429 0000 50005-0200
	5 m	77 1429 0000 50005-0500
	10 m	77 1429 0000 50005-1000

Male angled connector, moulded

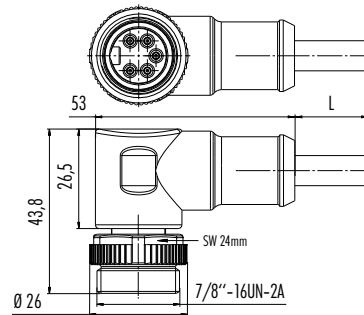

3 x 1,5	2 m	77 1427 0000 50003-0200
	5 m	77 1427 0000 50003-0500
	10 m	77 1427 0000 50003-1000
4 x 1,5	2 m	77 1427 0000 50004-0200
	5 m	77 1427 0000 50004-0500
	10 m	77 1427 0000 50004-1000
5 x 1,5	2 m	77 1427 0000 50005-0200
	5 m	77 1427 0000 50005-0500
	10 m	77 1427 0000 50005-1000

Female cable connector, moulded

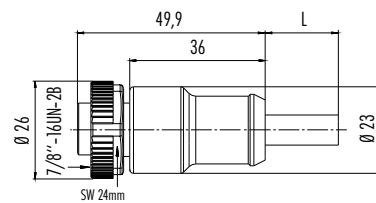

3 x 1,5	2 m	77 1430 0000 50003-0200
	5 m	77 1430 0000 50003-0500
	10 m	77 1430 0000 50003-1000
4 x 1,5	2 m	77 1430 0000 50004-0200
	5 m	77 1430 0000 50004-0500
	10 m	77 1430 0000 50004-1000
5 x 1,5	2 m	77 1430 0000 50005-0200
	5 m	77 1430 0000 50005-0500
	10 m	77 1430 0000 50005-1000

Female angled connector, moulded

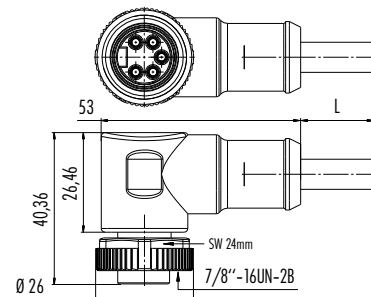

3 x 1,5	2 m	77 1434 0000 50003-0200
	5 m	77 1434 0000 50003-0500
	10 m	77 1434 0000 50003-1000
4 x 1,5	2 m	77 1434 0000 50004-0200
	5 m	77 1434 0000 50004-0500
	10 m	77 1434 0000 50004-1000
5 x 1,5	2 m	77 1434 0000 50005-0200
	5 m	77 1434 0000 50005-0500
	10 m	77 1434 0000 50005-1000

**Specifications**

Contacts	3, 2+PE	4, 3+PE	5, 4+PE
Wire gauge	max. 1,5 mm <sup>2</sup> (max. AWG 16)		max. 1,5 mm <sup>2</sup> – max. 2,5 mm <sup>2</sup> (max. AWG 16 – max. AWG 14)
Mechanical operation	> 100 Mating cycles, > 50 Mating cycles		
Temperature range	– 25 °C / + 80 °C, – 25 °C / + 85 °C		
Rated voltage	300 V (600 V UL)		
Pollution degree	3		
Rated current (40°C)	13 A, 12 A, 10 A	10 A, 9 A, 7 A	9 A, 9 A, 6 A
Contact plating	Au (Gold)		
Material of housing	PUR, PBT		

### Description

Male cable connector

### Drawing

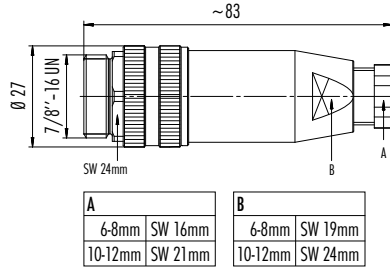

Contacts	Wire gauge	Cable outlet	Ordering-No.
2+PE		6-8 mm	99 2441 12 03
		10-12 mm	99 2441 32 03
3+PE	1,5 mm <sup>2</sup>	6-8 mm	99 2443 12 04
		10-12 mm	99 2443 32 04
4+PE	2,5 mm <sup>2</sup>	6-8 mm	99 2445 12 05
		10-12 mm	99 2445 32 05
		10-12 mm	99 2445 33 05

Male cable connector

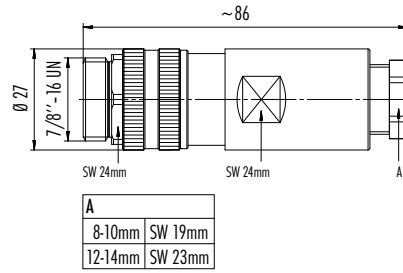

2+PE		8-10 mm	99 2441 21 03
		12-14 mm	99 2441 42 03
3+PE	1,5 mm <sup>2</sup>	8-10 mm	99 2443 21 04
		12-14 mm	99 2443 42 04
4+PE	2,5 mm <sup>2</sup>	8-10 mm	99 2445 21 05
		12-14 mm	99 2445 42 05
		8-10 mm	99 2445 23 05
		12-14 mm	99 2445 43 05

Male cable connector, stainless steel locking ring

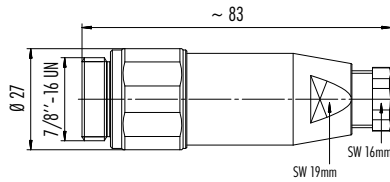

2+PE	1,5 mm <sup>2</sup>	6-8 mm	99 2441 282 03
3+PE			99 2443 282 04
4+PE			99 2445 282 05

Female cable connector

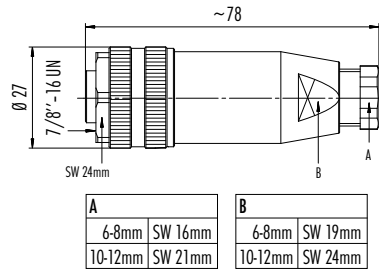

2+PE		6-8 mm	99 2440 12 03
		10-12 mm	99 2440 32 03
3+PE	1,5 mm <sup>2</sup>	6-8 mm	99 2442 12 04
		10-12 mm	99 2442 32 04
4+PE	2,5 mm <sup>2</sup>	6-8 mm	99 2444 12 05
		10-12 mm	99 2444 32 05
		10-12 mm	99 2444 33 05

Female cable connector

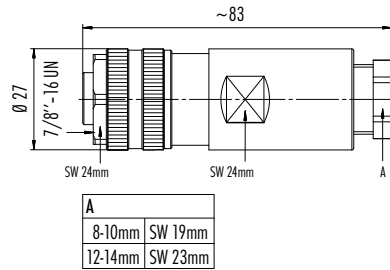

2+PE		8-10 mm	99 2440 21 03
		12-14 mm	99 2440 42 03
3+PE	1,5 mm <sup>2</sup>	8-10 mm	99 2442 21 04
		12-14 mm	99 2442 42 04
4+PE	2,5 mm <sup>2</sup>	8-10 mm	99 2444 21 05
		12-14 mm	99 2444 42 05
		8-10 mm	99 2444 23 05
		12-14 mm	99 2444 43 05

Female cable connector, stainless steel locking ring

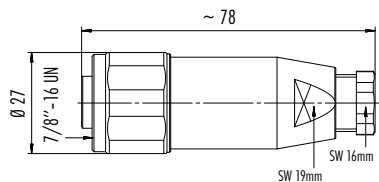

2+PE	1,5 mm <sup>2</sup>	6-8 mm	99 2440 282 03
3+PE			99 2442 282 04
4+PE			99 2444 282 05

**Description**

Male angled connector



**Drawing**

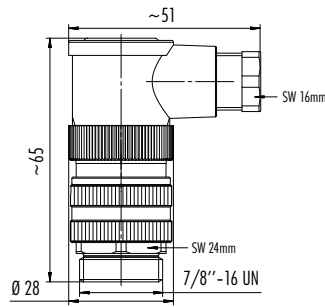

Contacts	Wire gauge	Cable outlet	Ordering-No.
2+PE			99 2441 52 03
3+PE	1,5 mm <sup>2</sup>	6-8 mm	99 2443 52 04
4+PE			99 2445 52 05

Male angled connector

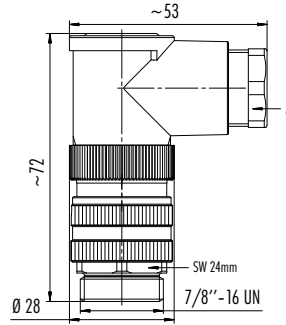

A	
8-10mm	SW 19mm
10-12mm	SW 21mm

2+PE	1,5 mm <sup>2</sup>	8-10 mm	99 2441 62 03
		10-12 mm	99 2441 72 03
3+PE	1,5 mm <sup>2</sup>	8-10 mm	99 2443 62 04
		10-12 mm	99 2443 72 04
4+PE	2,5 mm <sup>2</sup>	8-10 mm	99 2445 62 05
		10-12 mm	99 2445 72 05
		8-10 mm	99 2445 63 05
		10-12 mm	99 2445 73 05

Female angled connector

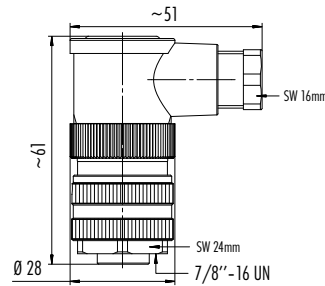

2+PE	1,5 mm <sup>2</sup>	6-8 mm	99 2440 52 03
3+PE			99 2442 52 04
4+PE			99 2444 52 05

Female angled connector

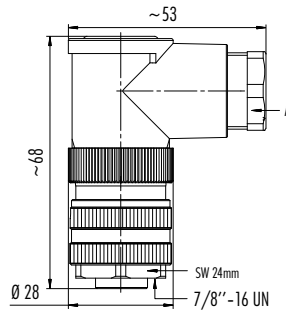

A	
8-10mm	SW 19mm
10-12mm	SW 21mm

2+PE	1,5 mm <sup>2</sup>	8-10 mm	99 2440 62 03
		10-12 mm	99 2440 72 03
3+PE	1,5 mm <sup>2</sup>	8-10 mm	99 2442 62 04
		10-12 mm	99 2442 72 04
4+PE	2,5 mm <sup>2</sup>	8-10 mm	99 2444 62 05
		10-12 mm	99 2444 72 05
		8-10 mm	99 2444 63 05
		10-12 mm	99 2444 73 05

**Component part drawing**

Cable connectors

Female insert/  
Male insert  
Sleeve  
Seal  
Pinch ring  
Pressing screw

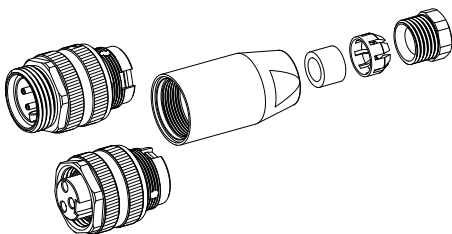

Angled connectors

Female insert/  
Male insert  
Angled sleeve mounted  
Angled housing  
Seal  
Pinch ring  
Pressing screw  
Cable outlet adjustable  
in 8 positions

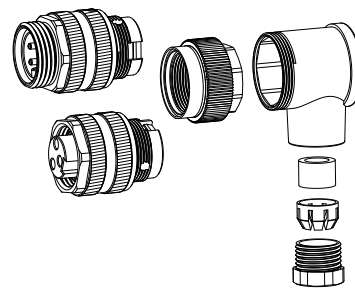

### Description

### Drawing

### Contacts

### Fixing thread

### Ordering-No.

Male panel mount connector, with single wires (AWG 18)

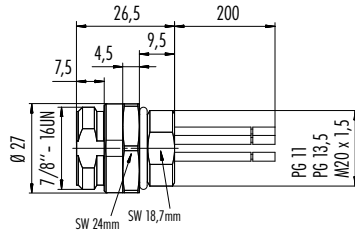

	PG 11	09 2447 310 03
2+PE	PG 13,5	09 2447 300 03
	M20 x 1,5	09 2447 320 03
4	PG 11	09 2449 310 04
	PG 13,5	09 2449 300 04
	M20 x 1,5	09 2449 320 04
	PG 11	09 2451 310 05
4+PE	PG 13,5	09 2451 300 05
	M20 x 1,5	09 2451 320 05

Male panel mount connector, front fastened, with single wires (AWG 18)

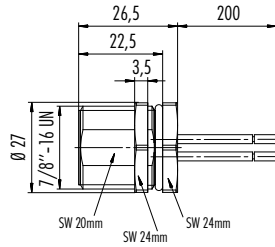

2+PE	–	09 2447 100 03
4	–	09 2449 100 04
4+PE	–	09 2451 100 05

Male panel mount connector, dip-solder

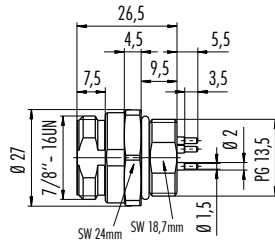

2+PE	–	09 2447 330 03
4	–	09 2449 330 04
4+PE	–	09 2451 330 05

Male panel mount connector, front fastened, dip-solder

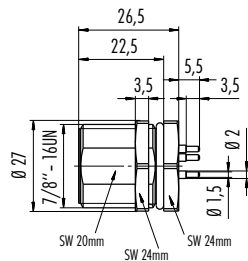

2+PE	–	09 2447 180 03
4	–	09 2449 180 04
4+PE	–	09 2451 180 05

Adapter lead-through for control cabinet

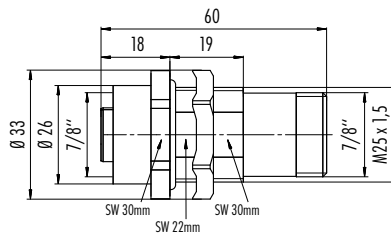

5	–	09 2472 00 05
---	---	---------------

Splitter, socket 7/8", pin/socket 7/8"

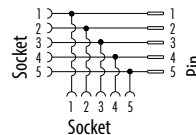
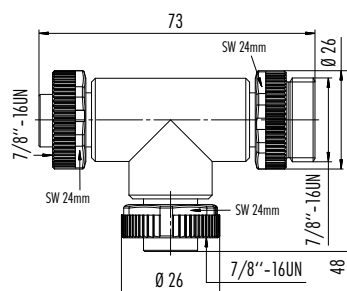

3 and 4 pole analogue

3	–	09 2473 100 03
4	–	09 2474 100 04
5	–	09 2475 100 05

**Description**

Female panel mount connector, with single wires (AWG 18)



**Drawing**

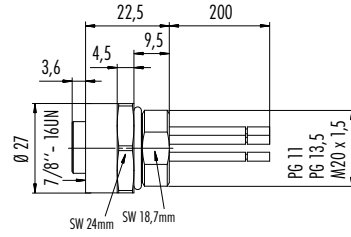

Contacts	Fixing thread	Ordering-No.
	PG 11	09 2446 310 03
2+PE	PG 13,5	09 2446 300 03
	M20 x 1,5	09 2446 320 03
4	PG 11	09 2448 310 04
	PG 13,5	09 2448 300 04
	M20 x 1,5	09 2448 320 04
4+PE	PG 11	09 2450 310 05
	PG 13,5	09 2450 300 05
	M20 x 1,5	09 2450 320 05

Female panel mount connector, front fastened, with single wires (AWG 18)

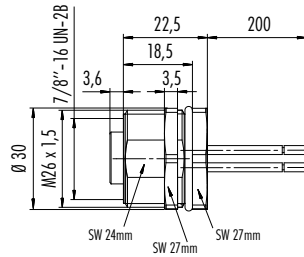

2+PE	–	09 2446 100 03
4	–	09 2448 100 04
4+PE	–	09 2450 100 05

Female panel mount connector, dip-solder

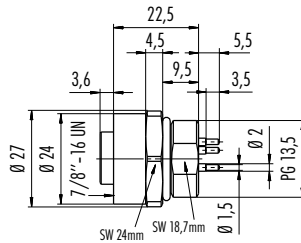

2+PE	–	09 2446 330 03
4	–	09 2448 330 04
4+PE	–	09 2450 330 05

Female panel mount connector, front fastened, dip-solder

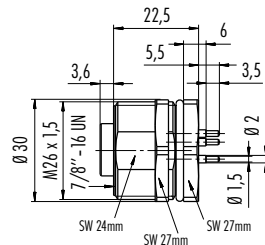

2+PE	–	09 2446 180 03
4	–	09 2448 180 04
4+PE	–	09 2450 180 05

**Contact arrangements male insert (mating side)**

3, 2+PE contacts

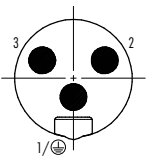

4, 3+PE contacts

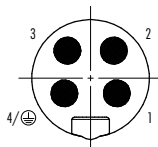

5, 4+PE contacts

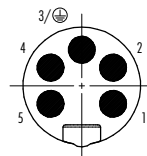

**Contact arrangements female insert (mating side)**

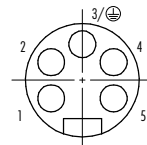
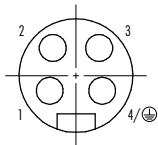
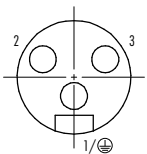

**Colour of wire, moulded cable and panel mount connectors**

3, 2+PE contacts	4, 3+PE contacts	5, 4+PE contacts
1 green/yellow	1 black	1 black
2 brown	2 blue	2 blue
3 blue	3 brown	3 green/yellow
	4 white	4 brown
		5 white



Panel cut out

Panel mount connector

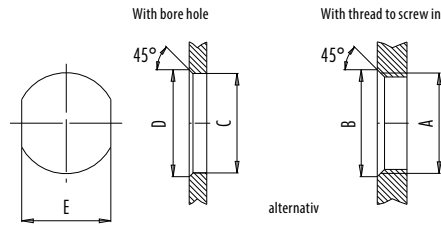

	A	B	C	D	E
PG11	PG11	20,2	18,7	20,2	17,0
PG13,5	PG13,5	22,0	20,5	22,0	18,8
M20x1,5	M20x1,5	21,6	20,1	21,6	17,8

Panel mount connector, front fastened

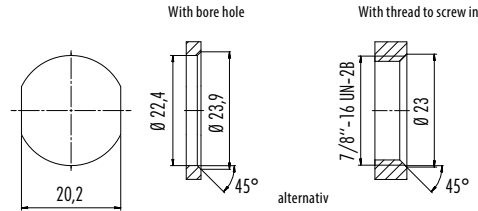

Description

Drawing

Ordering-No.

Protection cap for male cable connector

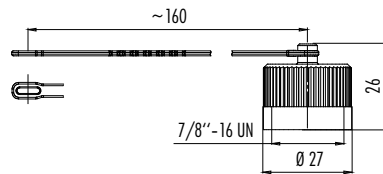

08 2807 000 000

Protection cap for female cable connector

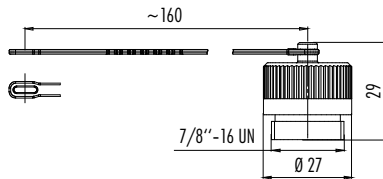

08 2808 000 000

Protection cap for male panel mount connector

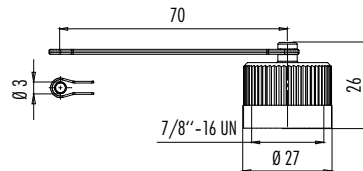

08 2809 000 000

Protection cap for female panel mount connector

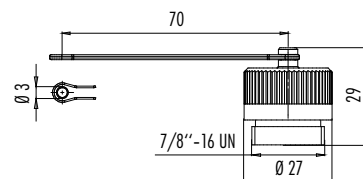

08 2811 000 000

Torque wrench

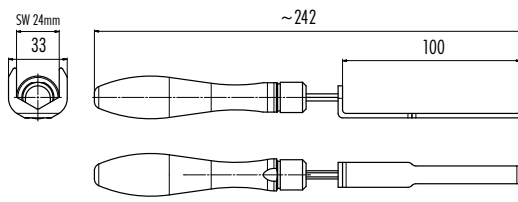

07 0082 000

Hexagonal nut for fixing thread

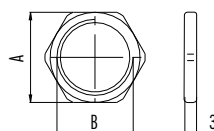

Fix. thread B      Wrench size A      Ordering-No.

PG 11	SW 21 mm	16 0403 001
PG 13,5	SW 23 mm	16 0401 001
M20 x 1,5	SW 24 mm	16 0917 001



- DIN EN 175301-803
- 2+PE, 3+PE
- Low and high housing
- Degree of protection IP65
- Wired versions
- Moulded versions
- Degree of protection IP67

**Description**

Female power connector, low housing

**Drawing**

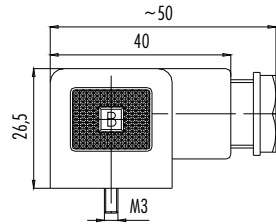

Contacts	Thread	Cable outlet	Ordering-No.
2+PE	PG 9	6–8 mm	43 1700 000 03
	M16	6–10 mm	43 1700 004 03
	PG 11	8–10 mm	43 1700 002 03
3+PE	PG 9	6–8 mm	43 1702 000 04
	M16	6–10 mm	43 1702 004 04
	PG 11	8–10 mm	43 1702 002 04

Female power connector, high housing

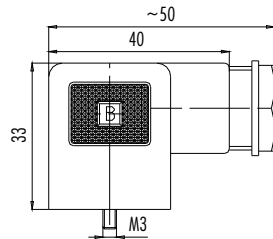

2+PE	PG 9	6–8 mm	43 1704 000 03
	M16	6–10 mm	43 1704 004 03
	PG 11	8–10 mm	43 1704 002 03
3+PE	PG 9	6–8 mm	43 1706 000 04
	M16	6–10 mm	43 1706 004 04
	PG 11	8–10 mm	43 1706 002 04

Female power connector, high housing, with 6,3 mm fast-on crimp contacts



Contacts	Thread	Cable outlet	Fast-on sleeve	Ordering-No.
2+PE	PG 9	6–8 mm	0,5–1,5 mm <sup>2</sup>	43 1708 011 00
			1,0–2,5 mm <sup>2</sup>	43 1708 012 00
	PG 11	8–10 mm	0,5–1,5 mm <sup>2</sup>	43 1708 013 00
			1,0–2,5 mm <sup>2</sup>	43 1708 014 00
3+PE	PG 9	6–8 mm	0,5–1,5 mm <sup>2</sup>	43 1708 015 00
			1,0–2,5 mm <sup>2</sup>	43 1708 016 00
	PG 11	8–10 mm	0,5–1,5 mm <sup>2</sup>	43 1708 017 00
			1,0–2,5 mm <sup>2</sup>	43 1708 018 00

**Specifications**

Contacts	2+PE	3+PE
Wire gauge	min. 0,34 mm <sup>2</sup> (min. AWG 22), max. 1,5 mm <sup>2</sup> (max. AWG 16), screw termination/fast-on sleeve 0,5–1,5 mm <sup>2</sup> , 1,0–2,5 mm <sup>2</sup>	
Mechanical operation	> 50 Mating cycles	
Temperature range	– 30 °C / + 110 °C	
Rated voltage	250 V	
Pollution degree	3	
Current (40°C)	10 A	
Contact plating	Ni (Nickel)	
Material of housing	PA	

### Description

Female power connector, high housing, wired

### Drawing

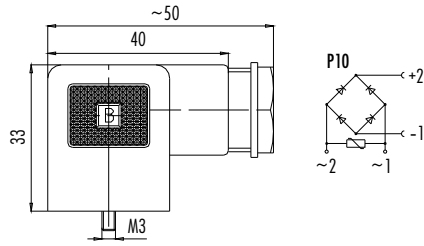

Contacts	Cable outlet	Wiring	Current	Ordering-No.
2+PE	6-8 mm	P10 230 V	2 A	43 1726 110 03
	8-10 mm			43 1726 112 03

Female power connector, low housing, wired, LED

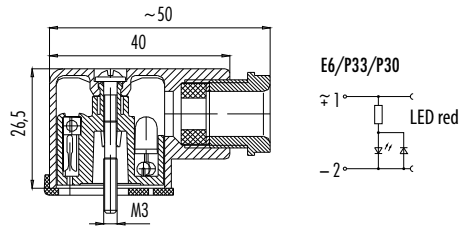

2+PE	6-8 mm	E6 24 V	10 A	43 1714 135 03
		P33 110 V		43 1714 133 03
	P30 230 V	43 1714 131 03		
	E6 24 V	43 1714 136 03		
	8-10 mm	P33 110 V		43 1714 134 03
		P30 230 V		43 1714 132 03

Female power connector, high housing, wired, LED

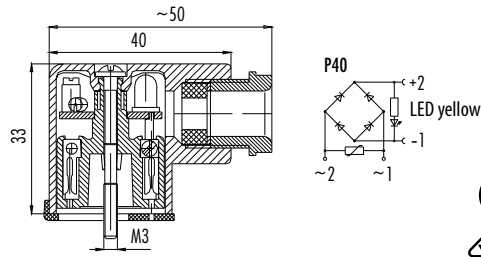

2+PE	6-8 mm	P40 230 V	2 A	43 1730 140 03
	8-10 mm			43 1730 142 03

Adapter, female power connector, low housing, M12

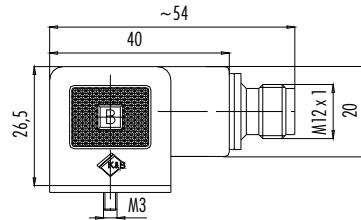

2+PE	-	-	60 V	4 A	99 5700 00 03
3+PE	-	-	-	-	99 5702 00 04

### Component part drawing

Female power connector (PG 9, M16)

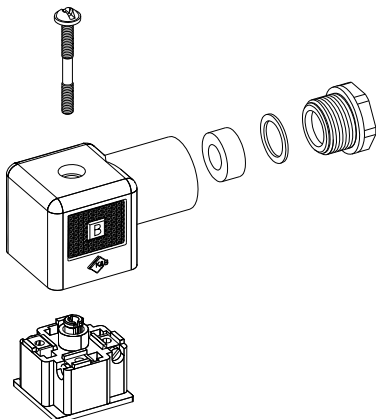

Female power connector with strain relief (PG 9)

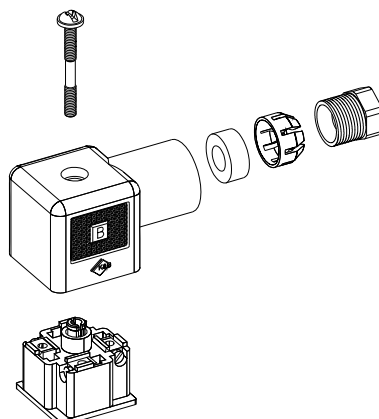

### Contact arrangements

2+PE/3+PE contacts

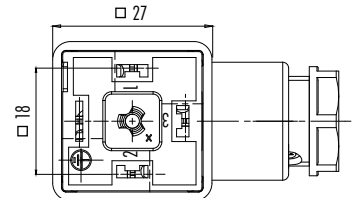

### Description

Female solenoid valve connector, moulded



### Drawing

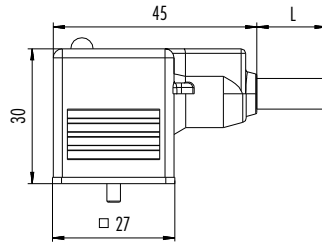

Contacts	Voltage	Current	Cable length, PUR	Ordering-No.
2+PE x 0,75	250 V	10 A	3 m	31 5234 300 000
			5 m	31 5234 500 000
3+PE x 0,75			3 m	31 5235 300 000
			5 m	31 5235 500 000

Female solenoid valve connector, moulded, wired, LED

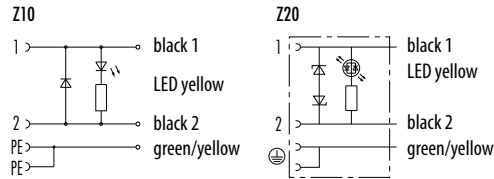

Contacts	Wiring	Current	Cable length, PUR	Ordering-No.
2+PE x 0,75	Z10 24V	10 A	3 m	31 5236 300 510
			5 m	31 5236 500 510
	Z20 24V		3 m	31 5237 300 520
			5 m	31 5237 500 520

Connecting cable female power connector – male cable connector M12

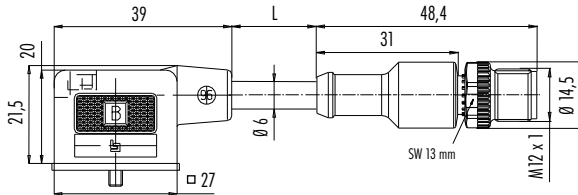

Contacts	Voltage	Current	Cable length, PUR	Ordering-No.
2+PE x 0,75	60 V	4 A	1 m	79 5700 10 03
			2 m	79 5700 20 03

Connecting cable female power connector, wired, LED – male cable connector M12

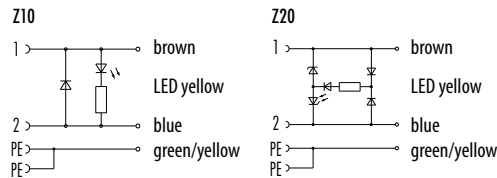

Contacts	Wiring	Current	Cable length, PUR	Ordering-No.
2+PE x 0,75	Z10 24V	4 A	1 m	79 5704 10 03
			2 m	79 5704 20 03
	Z20 24V		1 m	79 5706 10 03
			2 m	79 5706 20 03

Connecting cable female power connector – male angled connector M12

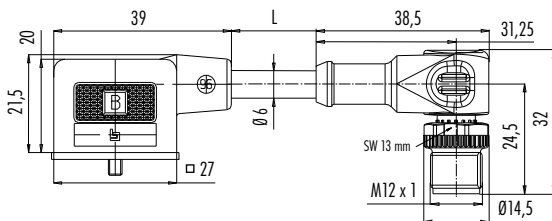

Contacts	Voltage	Current	Cable length, PUR	Ordering-No.
2+PE x 0,75	60 V	4 A	1 m	79 5701 10 03
			2 m	79 5701 20 03
3+PE x 0,75			1 m	79 5703 10 04
			2 m	79 5703 20 04

Connecting cable female power connector, wired, LED – male angled connector M12

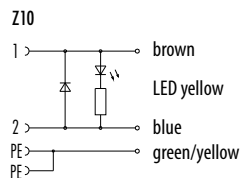

Contacts	Wiring	Current	Cable length, PUR	Ordering-No.
2+PE x 0,75	Z10 24V	4 A	1 m	79 5705 10 03
			2 m	79 5705 20 03

### Description

### Drawing

### Contacts Ordering-No.

Male circular power connector

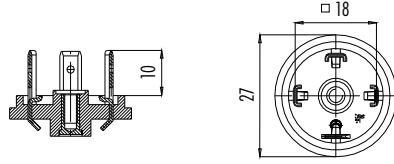

2+PE	43 1701 000 03
3+PE	43 1703 000 04

Male circular power connector, coupling ring M27 x 1,5

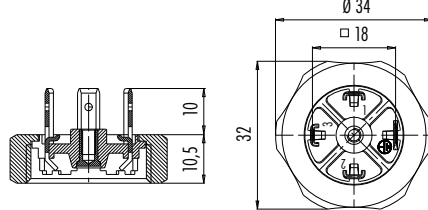

2+PE	43 1705 005 03
3+PE	43 1707 005 04
3+PE	43 1707 019 04 gold plated contacts

Male rectangular power connector, 2 mounting holes

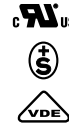
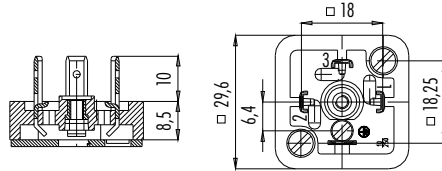

2+PE	43 1709 000 03
3+PE	43 1711 000 04

Male rectangular power connector, radius

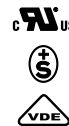
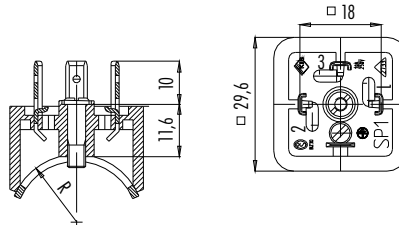

Contacts	Ordering-No.	Radius	Index (xxx)
		17 mm	021
		20 mm	022
2+PE	43 1717 xxx 03	22 mm	023
		25 mm	024
		28 mm	025
		31 mm	026
		35 mm	027
3+PE	43 1719 xxx 04	41 mm	028
		45 mm	029
		51 mm	030

Male rectangular power connector, 4 mounting holes

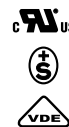
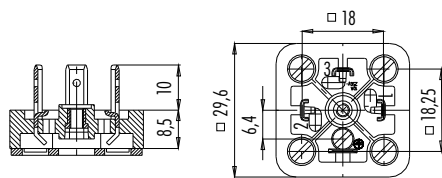

2+PE	43 1713 000 03
3+PE	43 1715 000 04

### Contact arrangements

2+PE contacts, PE connected protective earth

3+PE contacts

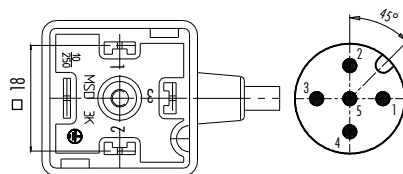
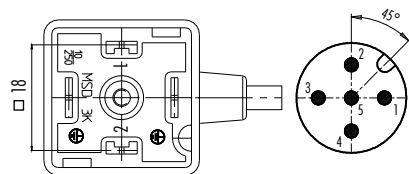

### Colour of wire, moulded solenoid valve connectors and connecting cables

2+PE contacts	M12	3+PE contacts	M12
1	brown	1	brown
2	blue	2	blue
⊕	green/yellow	3	black
		⊕	green/yellow
		5	green/yellow

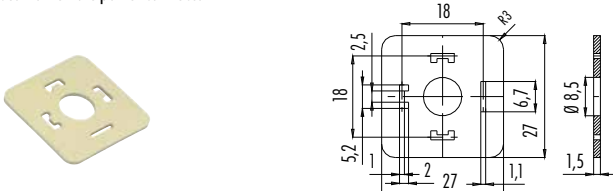
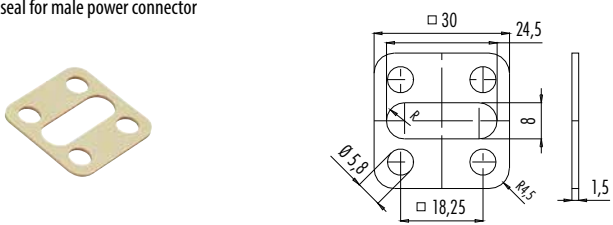
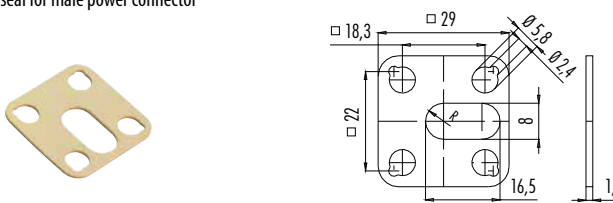
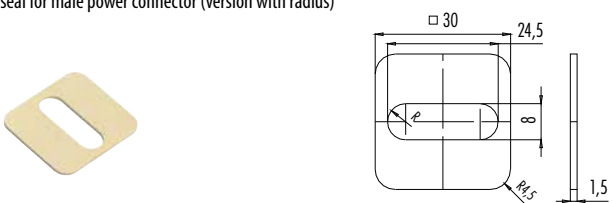
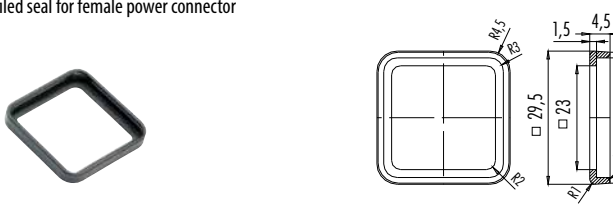
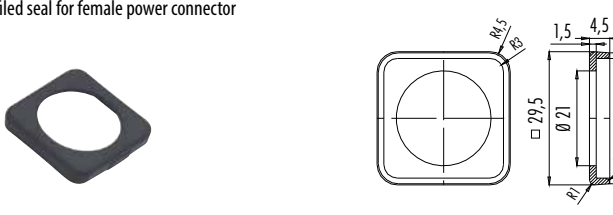
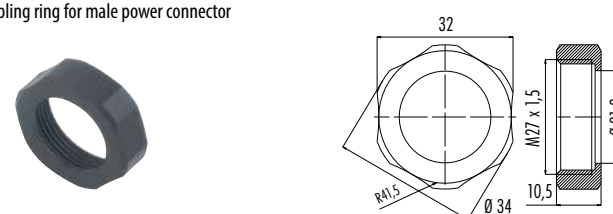
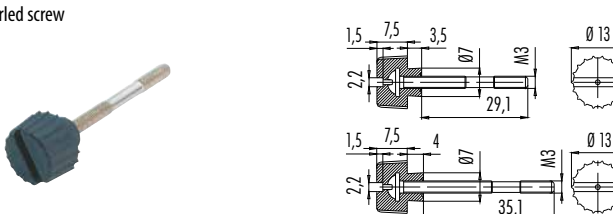
Description	Drawing	Material <sup>1)</sup>	Colour	Ordering-No.
Flat seal for female power connector		NBR Silicon	beige red	16 8085 000 16 8085 001
Flat seal for male power connector		NBR Silicon	beige red	16 8090 000 16 8090 001
Flat seal for male power connector		NBR Silicon	beige red	16 8089 000 16 8089 001
Flat seal for male power connector (version with radius)		NBR Silicon	beige red	16 8092 000 16 8092 001
Profiled seal for female power connector		NBR	black	16 8088 000
Profiled seal for female power connector		NBR	black	16 8114 000
Coupling ring for male power connector				Ordering-No. 16 8114 000
Knurled screw		16 8096 131 16 8104 131	(29,1 mm) (35,1 mm)	
		Material <sup>1)</sup>	Colour	Temperature range of seals
		NBR	beige	-40 °C/+ 100 °C
		NBR	black	-20 °C/+ 125 °C
		Silicon	red	-60 °C/+ 250 °C

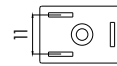

- DIN EN 175301-803
- Industrial standard
- 2+PE
- Low housing
- Degree of protection IP65
- Wired versions
- Moulded versions
- Degree of protection IP67

Description	Drawing	Contacts	Cable outlet	Ordering-No.
Female power connector		2+PE	6-8 mm	43 1830 000 03

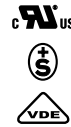
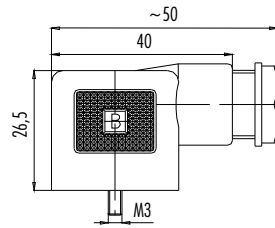

Contacts	Cable outlet	Wiring	Current	Ordering-No.
2+PE	6-8 mm	E6 24 V	10 A	43 1834 135 03
		P30 220 V		43 1834 130 03

Female power connector, wired, LED

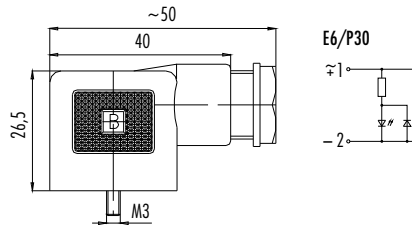

Contacts	Voltage	Current	Cable length, PUR	Ordering-No.
2+PE x 0,75	250 V	10 A	3 m	30 5535 300 000
			5 m	30 5535 500 000

Female solenoid valve connector, moulded

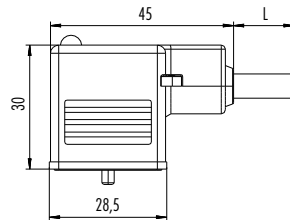

Contacts	Wiring	Current	Cable length, PUR	Ordering-No.
2+PE x 0,75	Z10 24 V	10 A	3 m	30 5537 300 510
			5 m	30 5537 500 510
	Z20 24 V		3 m	30 5539 300 520
			5 m	30 5539 500 520

Female solenoid valve connector, moulded, wired, LED

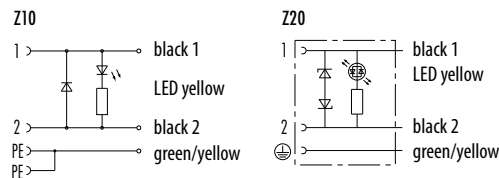

### Specifications

Contacts	2+PE
Wire gauge	min. 0,34 mm <sup>2</sup> (min. AWG 22), max. 1,5 mm <sup>2</sup> (max. AWG 16)
Mechanical operation	> 50 Mating cycles
Temperature range	-20 °C/+120 °C
Rated voltage	250 V
Pollution degree	3
Current (40°C)	10 A
Contact plating	Ni (Nickel)
Material of housing	PA

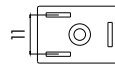

Description	Drawing	Contacts	Voltage	Current	Cable length, PUR	Ordering-No.
Connecting cable female power connector – male cable connector M12		2+PE x 0,75	60 V	4 A	1 m	79 5712 10 03
					2 m	79 5712 20 03

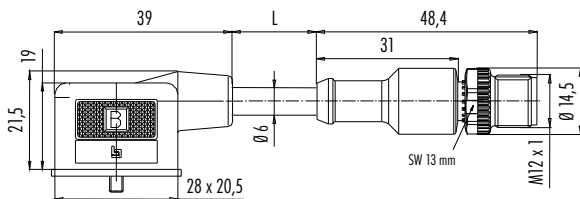

Contacts	Wiring	Current	Cable length, PUR	Ordering-No.
2+PE x 0,75	Z10 24 V	4 A	1 m	79 5714 10 03
			2 m	79 5714 20 03

Connecting cable female power connector, wired, LED – male cable connector M12

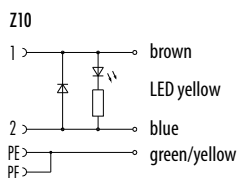

Contacts	Voltage	Current	Cable length, PUR	Ordering-No.
2+PE x 0,75	60 V	4 A	1 m	79 5713 10 03
			2 m	79 5713 20 03

Connecting cable female power connector – male angled connector M12

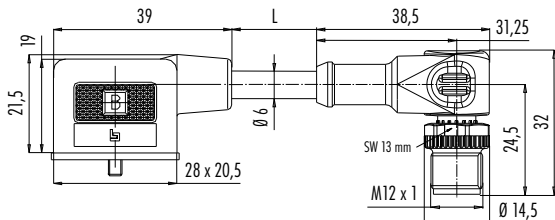

Contacts	Wiring	Current	Cable length, PUR	Ordering-No.
2+PE x 0,75	Z10 24 V	4 A	1 m	79 5715 10 03
			2 m	79 5715 20 03
	Z20 24 V		1 m	79 5717 10 03
			2 m	79 5717 20 03

Connecting cable female power connector, wired, LED – male angled connector M12

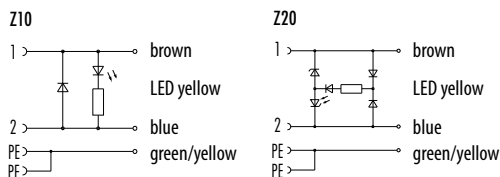

Contacts	Ordering-No.
2+PE	43 1831 000 03

Male power connector

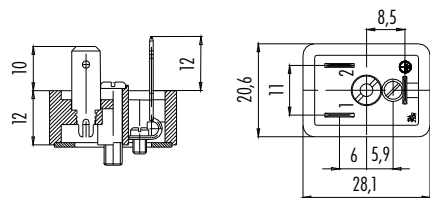

### Contact arrangements

2+PE contacts

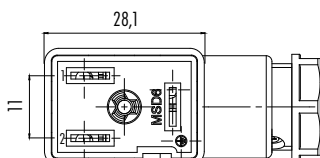

Using rotatable by 180°

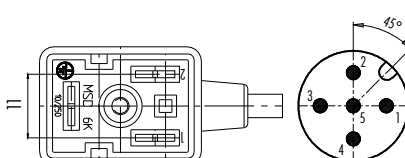

Nonrotatably use

### Colour of wire, moulded solenoid valve connectors and connecting cables

2+PE contacts	M12
1	brown 3 blue
2	blue 4 brown
⊕	green/yellow 5 yellow/green



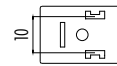

Description	Drawing	Contacts	Cable outlet	Ordering-No.
Female power connector		2+PE	6-8 mm	43 1800 000 03

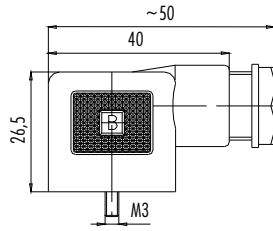

Female solenoid valve connector, moulded

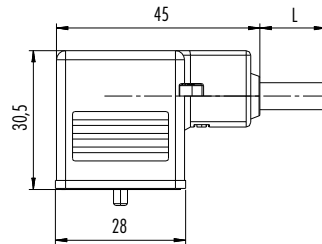

Contacts	Voltage	Current	Cable length, PUR	Ordering-No.
2+PE x 0,75	250 V	10 A	3 m	32 5335 300 000
			5 m	32 5335 500 000

Female solenoid valve connector, moulded, wired, LED

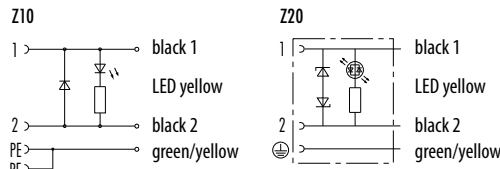

Contacts	Wiring	Current	Cable length, PUR	Ordering-No.
2+PE x 0,75	Z10 24V	10 A	3 m	32 5337 300 510
			5 m	32 5337 500 510
	Z20 24V		3 m	32 5339 300 520
			5 m	32 5339 500 520

Connecting cable female power connector – male cable connector M12

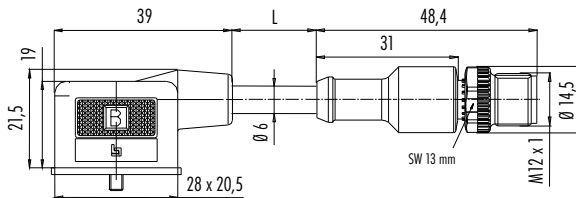

Contacts	Voltage	Current	Cable length, PUR	Ordering-No.
2+PE x 0,75	60 V	4 A	1 m	79 5718 10 03
			2 m	79 5718 20 03

Connecting cable female power connector, wired, LED – male cable connector M12

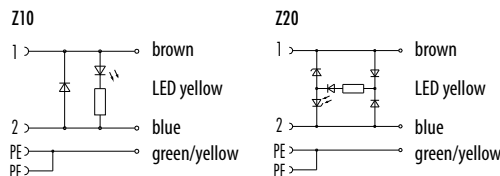

Contacts	Wiring	Current	Cable length, PUR	Ordering-No.
2+PE x 0,75	Z10 24V	4 A	1 m	79 5720 10 03
			2 m	79 5720 20 03
	Z20 24V		1 m	79 5722 10 03
			2 m	79 5722 20 03

Connecting cable female power connector – Male angled connector M12

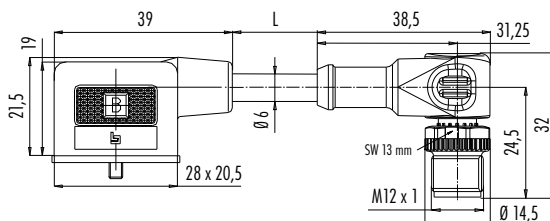

Contacts	Voltage	Current	Cable length, PUR	Ordering-No.
2+PE x 0,75	60 V	4 A	1 m	79 5719 10 03
			2 m	79 5719 20 03

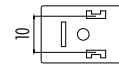

Description	Drawing	Contacts	Wiring	Current	Cable length, PUR	Ordering-No.
Connecting cable female power connector, wired, LED – male angled connector M12		2+PE x 0,75	Z10 24V	4 A	1 m	79 5721 10 03
					2 m	79 5721 20 03

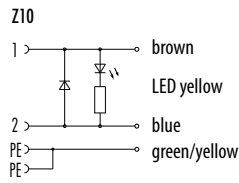

Contacts	Ordering-No.
2+PE	43 1801 000 03

Male power connector

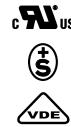
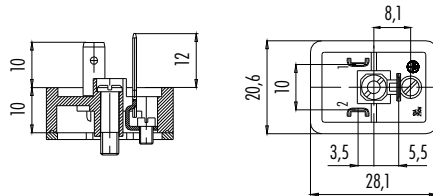

### Contact arrangements

2+PE contacts

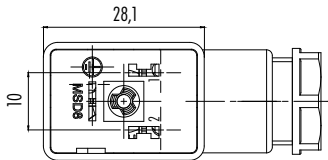

Using rotatable by 180°

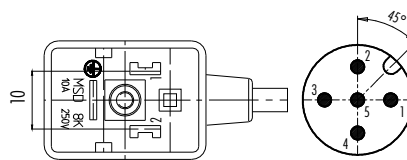

Nonrotatably use

### Colour of wire, moulded solenoid valve connectors and connecting cables

- 2+PE contacts M12
- 1 brown
  - 2 blue
  - 3 blue
  - 4 brown
  - 5 yellow/green
  - ⊕ green/yellow





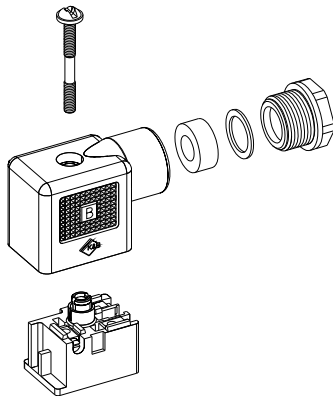



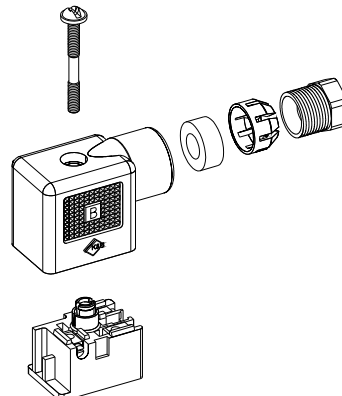

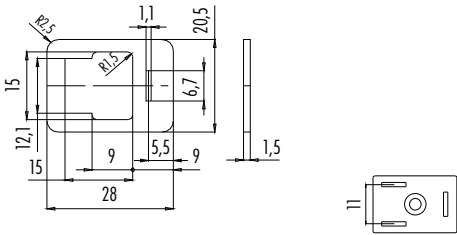

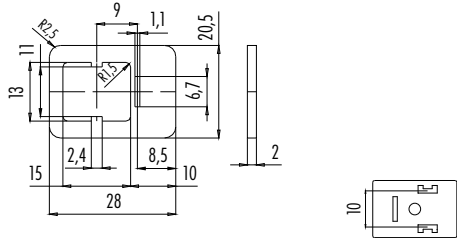

### Component part drawing

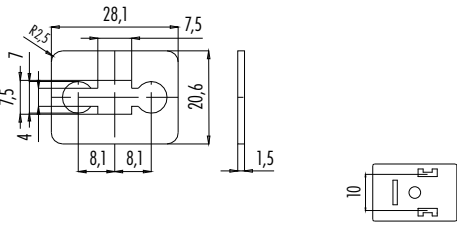
Female power connector (PG 9, M16)

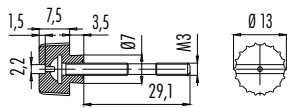

Female power connector with strain relief (PG 9)

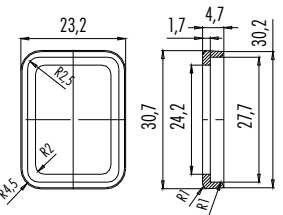
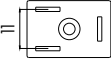
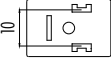

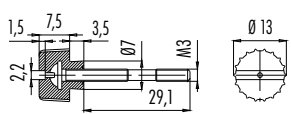
Description	Drawing	Material <sup>1)</sup>	Colour	Ordering-No.
Flat seal, industrial standard, for female power connector	  	NBR Silicon	beige red	16 8093 000 16 8093 001
Flat seal, industrial standard, for male power connector	  	NBR Silicon	beige red	16 8094 000 16 8094 001
Flat seal, DIN, for female power connector	  	NBR Silicon	beige red	16 8100 000 16 8100 001
Flat seal, DIN, for male power connector	  	NBR	beige	16 8101 000
Profiled seal, industrial standard/DIN, for female power connector	   	NBR	black	16 8105 000
Knurled screw	 			16 8096 131
		Material <sup>1)</sup>	Colour	Temperature range of seals
		NBR	beige	-40 °C/+ 100 °C
		NBR	black	-20 °C/+ 125 °C
		Silicon	red	-60 °C/+ 250 °C

<sup>1)</sup> Note the Temperature range, see table



- DIN EN 175301-803
- Industrial standard
- 2+PE, 3+PE
- Degree of protection IP65
- Wired versions
- Moulded versions
- Degree of protection IP67

### Description

Female power connector

### Drawing

Contacts	Cable outlet	Ordering-No.
2+PE	4-6 mm	43 1930 000 03
3+PE		43 1932 000 04

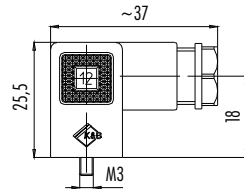

Female power connector, metric thread M12

2+PE	4-6 mm	43 1930 004 03
3+PE		43 1932 004 04



Female solenoid valve connector, moulded

Contacts	Voltage	Current	Cable length, PUR	Ordering-No.
2+2PE x 0,5	250 V	6 A	3 m	33 5934 300 000
			5 m	33 5934 500 000

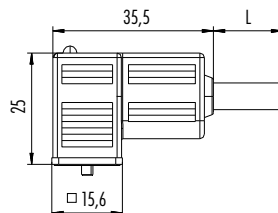

Female solenoid valve connector, moulded, wired, LED

Contacts	Wiring	Current	Cable length, PUR	Ordering-No.
2+2PE x 0,5	Z20 24 V	4 A	3 m	33 5937 300 520
			5 m	33 5937 500 520

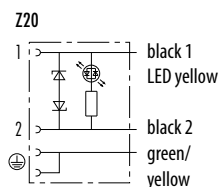

### Specifications

Contacts	2+PE	3+PE	2+2PE
Wire gauge	min. 0,14 mm <sup>2</sup> (min. AWG 26), max. 0,75 mm <sup>2</sup> (max. AWG 20)		0,5 mm <sup>2</sup> (AWG 20)
Mechanical operation	> 50 Mating cycles		
Temperature range	-20 °C / +120 °C		-20 °C / +80 °C
Rated voltage	250 V		230 V, 24 V AC/DC
Pollution degree	3		
Current (40°C)	6 A		4 A
Contact plating	Ni (Nickel)		Ag (Silver)
Material of housing	PA		UL 94-HB, TPU



Description	Drawing	Contacts	Cable outlet	Ordering-No.
Female power connector		2+PE	4-6 mm	43 1900 000 03
		3+PE		43 1902 000 04

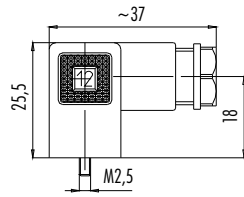

Female power connector, metric thread M12		2+PE	4-6 mm	43 1900 004 03
		3+PE		43 1902 004 04



Description	Drawing	Contacts	Voltage	Current	Cable length, PUR	Ordering-No.
Female solenoid valve connector, moulded		2+2PE x 0,5	250 V	6 A	3 m	34 5734 300 000
					5 m	34 5734 500 000

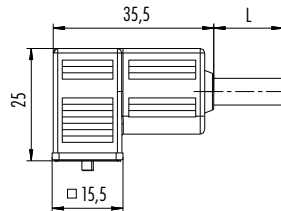

Female solenoid valve connector, moulded, wired, LED		2+2PE x 0,5	Z20 24 V	4 A	3 m	34 5737 300 520
					5 m	34 5737 500 520

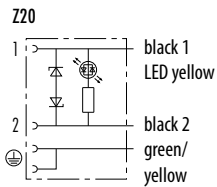

Contacts	Wiring	Current	Cable length, PUR	Ordering-No.
2+2PE x 0,5	Z20 24 V	4 A	3 m	34 5737 300 520
			5 m	34 5737 500 520

Description	Drawing	Contacts	Ordering-No.
Male power connector		2+PE	43 1901 000 03
		3+PE	43 1903 000 04

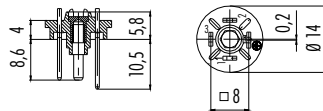

Male power connector		2+PE	43 1905 000 03
		3+PE	43 1907 000 04

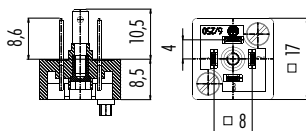

## Contact arrangements industrial standard

2+PE/3+PE contacts

2+PE

3+PE

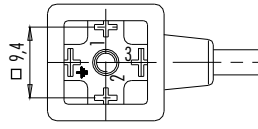
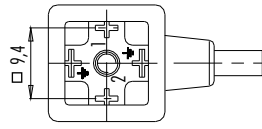
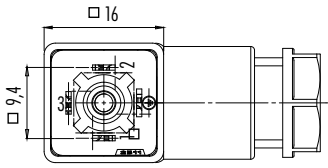

## Contact arrangements DIN 175301-803

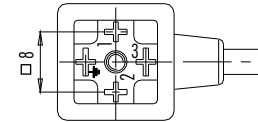
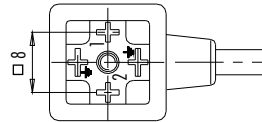
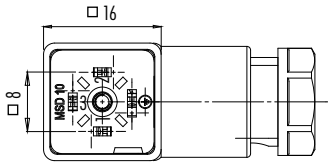

### Colour of wire, moulded solenoid valve connectors

- 1 black 1
- 2 black 2
- 3 black 3
- ⊕ green/yellow

Description	Drawing	Material <sup>1)</sup>	Colour	Ordering-No.
-------------	---------	------------------------	--------	--------------

Flat seal, industrial standard, for female power connector

NBR beige 16 8110 000

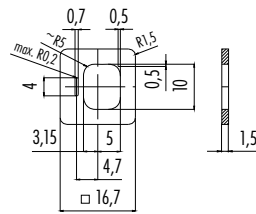

Flat seal, DIN, for female power connector

NBR beige 16 8107 000  
 Silicon red 16 8107 001  
 HNBR black 16 8107 002

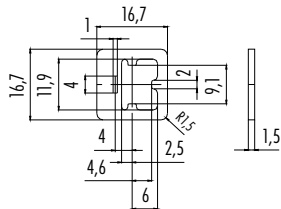

Flat seal, DIN, for male power connector

NBR black 16 8097 000

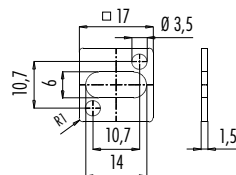

Profiled seal, industrial standard/DIN, for female power connector

NBR black 16 8106 071

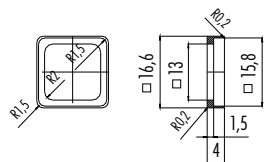

### Material <sup>1)</sup> Colour Temperature range of seals

NBR	beige	-40 °C/+ 100 °C
Silicon	red	-60 °C/+ 250 °C
NBR	black	-20 °C/+ 125 °C
HNBR	black	-40 °C/+ 125 °C



# Index

Part number	Series	Page	Part number	Series	Page	Part number	Series	Page	Part number	Series	Page
01 0010 001	678	36	08 1205 000 000	623	70	09 0104 300 02	423 - 723 - 425	61	09 0124 702 06	423 - 723 - 425	62
01 0010 001	581 - 680 - 682	53	08 2300 000 000	693	78	09 0105 25 03	723	58	09 0124 780 06	423 - 723 - 425	62
01 0010 001	423 - 723 - 425	64	08 2302 000 000	693	78	09 0105 70 03	723	58	09 0124 782 06	423 - 723 - 425	62
01 0013 001	712 - 702	27	08 2424 010 000	M12	141	09 0106 25 03	723	58	09 0124 80 06	423 - 723 - 425	61
01 0146 001	678	36	08 2425 010 000	M12	141	09 0106 70 03	723	58	09 0124 90 06	423 - 723 - 425	61
01 0146 001	581 - 680 - 682	53	08 2433 000 001	720	30	09 0107 00 03	423 - 723 - 425	59	09 0125 25 07	723	58
01 0146 001	423 - 723 - 425	65	08 2433 400 001	720	91	09 0107 300 03	423 - 723 - 425	59	09 0125 70 07	723	58
01 0769 001	768 - 718	109	08 2434 000 001	720	30	09 0107 80 03	423 - 723 - 425	59	09 0126 25 07	723	58
01 5006 001	678	36	08 2441 000 000	768 - 718	109	09 0107 90 03	423 - 723 - 425	59	09 0126 70 07	723	58
01 5006 001	581 - 680 - 682	53	08 2559 000 000	720	32	09 0108 00 03	423 - 723 - 425	61	09 0127 00 07	423 - 723 - 425	59
01 5006 001	423 - 723 - 425	65	08 2567 000 000	720	32	09 0108 290 03	423 - 723 - 425	61	09 0127 300 07	423 - 723 - 425	59
01 5023 001	712 - 702	27	08 2586 000 000	720	32	09 0108 300 03	423 - 723 - 425	61	09 0127 320 07	423 - 723 - 425	60
01 5059 001	712 - 702	27	08 2587 000 000	720	32	09 0108 80 03	423 - 723 - 425	61	09 0127 370 07	423 - 723 - 425	60
01 5118 001	707	96	08 2603 000 000	440	42	09 0108 90 03	423 - 723 - 425	61	09 0127 65 07	423 - 723 - 425	60
01 5244 001	M12	142	08 2604 000 001	440	42	09 0109 25 04	723	58	09 0127 700 07	423 - 723 - 425	59
01 5322 001	M12	142	08 2605 000 001	440	42	09 0109 70 04	723	58	09 0127 702 07	423 - 723 - 425	60
01 5325 001	M12	142	08 2606 000 001	440	42	09 0110 25 04	723	58	09 0127 780 07	423 - 723 - 425	60
02 0007 000	581 - 680 - 682	53	08 2610 000 000	707	96	09 0110 70 04	723	58	09 0127 782 07	423 - 723 - 425	60
02 0007 000	423 - 723 - 425	65	08 2615 000 000	M12	141	09 0111 00 04	423 - 723 - 425	59	09 0127 80 07	423 - 723 - 425	59
02 0054 000	581 - 680 - 682	53	08 2616 000 000	M12	141	09 0111 300 04	423 - 723 - 425	59	09 0127 90 07	423 - 723 - 425	59
02 0055 000	581 - 680 - 682	53	08 2629 000 001	620	10	09 0111 320 04	423 - 723 - 425	60	09 0128 00 07	423 - 723 - 425	61
02 0055 001	581 - 680 - 682	53	08 2636 000 001	620	10	09 0111 370 04	423 - 723 - 425	60	09 0128 290 07	423 - 723 - 425	61
02 0273 000	M12	143	08 2636 400 001	620	89	09 0111 700 04	423 - 723 - 425	59	09 0128 300 07	423 - 723 - 425	61
02 1785 000	581 - 680 - 682	53	08 2668 000 001	678	36	09 0111 702 04	423 - 723 - 425	60	09 0128 320 07	423 - 723 - 425	62
02 1785 000	423 - 723 - 425	65	08 2668 000 001	581 - 680 - 682	53	09 0111 780 04	423 - 723 - 425	60	09 0128 370 07	423 - 723 - 425	62
04 0106 001	678	36	08 2668 000 001	423 - 723 - 425	65	09 0111 782 04	423 - 723 - 425	60	09 0128 65 07	423 - 723 - 425	62
04 0106 001	581 - 680 - 682	53	08 2670 000 000	423 - 723 - 425	64	09 0111 80 04	423 - 723 - 425	59	09 0128 700 07	423 - 723 - 425	61
04 0183 009	581 - 680 - 682	53	08 2671 000 000	423 - 723 - 425	64	09 0111 90 04	423 - 723 - 425	59	09 0128 702 07	423 - 723 - 425	62
04 0186 009	423 - 723 - 425	65	08 2673 000 000	693	78	09 0112 00 04	423 - 723 - 425	61	09 0128 780 07	423 - 723 - 425	62
04 0208 002	712 - 702	27	08 2674 000 000	720	32	09 0112 290 04	423 - 723 - 425	61	09 0128 782 07	423 - 723 - 425	62
04 0722 000	693	79	08 2675 000 000	720	32	09 0112 300 04	423 - 723 - 425	61	09 0128 80 07	423 - 723 - 425	61
04 0734 124	M12	142	08 2676 000 000	M12	141	09 0112 320 04	423 - 723 - 425	62	09 0128 90 07	423 - 723 - 425	61
04 0735 124	M12	142	08 2677 000 000	M12	141	09 0112 370 04	423 - 723 - 425	62	09 0129 25 12	723	58
07 0010 001	678	36	08 2679 000 001	440	42	09 0112 700 04	423 - 723 - 425	61	09 0129 70 12	723	58
07 0010 001	581 - 680 - 682	53	08 2680 000 000	720	32	09 0112 702 04	423 - 723 - 425	62	09 0130 25 12	723	58
07 0010 001	423 - 723 - 425	64	08 2681 000 000	720	32	09 0112 780 04	423 - 723 - 425	62	09 0130 70 12	723	58
07 0078 000	M12	143	08 2769 000 000	M12	141	09 0112 782 04	423 - 723 - 425	62	09 0131 00 12	423 - 723 - 425	59
07 0079 000	M12	143	08 2807 000 000	820 - 870	199	09 0112 80 04	423 - 723 - 425	61	09 0131 290 12	423 - 723 - 425	59
07 0082 000	820 - 870	199	08 2808 000 000	820 - 870	199	09 0112 90 04	423 - 723 - 425	61	09 0131 300 12	423 - 723 - 425	59
07 0083 000	M12	142	08 2809 000 000	820 - 870	199	09 0113 25 05	723	58	09 0131 65 12	423 - 723 - 425	60
07 0084 000	M12	142	08 2811 000 000	820 - 870	199	09 0113 70 05	723	58	09 0131 66 12	423 - 723 - 425	60
07 0085 000	768 - 718	109	08 2813 000 000	620	11	09 0114 25 05	723	58	09 0131 80 12	423 - 723 - 425	59
07 0086 000	M12	143	08 2823 000 000	620	11	09 0114 70 05	723	58	09 0131 90 12	423 - 723 - 425	59
07 0090 000	581 - 680 - 682	53	08 2831 000 000	620	11	09 0115 00 05	423 - 723 - 425	59	09 0132 00 12	423 - 723 - 425	61
07 0090 000	423 - 723 - 425	65	08 2839 000 000	620	11	09 0115 290 05	423 - 723 - 425	59	09 0132 290 12	423 - 723 - 425	61
07 0090 000	696	83	08 2840 000 000	768 - 718	108	09 0115 300 05	423 - 723 - 425	59	09 0132 300 12	423 - 723 - 425	61
08 0045 000 001	423 - 723 - 425	64	08 2841 000 000	768 - 718	108	09 0115 320 05	423 - 723 - 425	60	09 0132 65 12	423 - 723 - 425	62
08 0349 000 001	712 - 702	27	08 2842 000 000	768 - 718	109	09 0115 370 05	423 - 723 - 425	60	09 0132 66 12	423 - 723 - 425	62
08 0350 000 001	712 - 702	27	08 2843 000 000	768 - 718	109	09 0115 700 05	423 - 723 - 425	59	09 0132 80 12	423 - 723 - 425	61
08 0351 000 001	712 - 702	27	08 2965 000 000	430	17	09 0115 702 05	423 - 723 - 425	60	09 0132 90 12	423 - 723 - 425	61
08 0352 000 001	712 - 702	27	08 2966 000 000	430	17	09 0115 780 05	423 - 723 - 425	60	09 0135 70 03	682	46
08 0462 000 000	M12	143	08 2972 000 000	768 - 718	109	09 0115 782 05	423 - 723 - 425	60	09 0135 72 03	682	46
08 0628 000 008	693	79	08 2973 000 000	768 - 718	109	09 0115 80 05	423 - 723 - 425	59	09 0136 70 03	682	47
08 1077 000 000	423 - 723 - 425	64	08 2989 000 000	M12	141	09 0115 90 05	423 - 723 - 425	59	09 0136 72 03	682	47
08 1078 000 000	423 - 723 - 425	64	08 2990 000 000	M12	141	09 0116 00 05	423 - 723 - 425	61	09 0137 70 04	682	46
08 1079 000 000	423 - 723 - 425	64	08 2991 000 000	M12	141	09 0116 290 05	423 - 723 - 425	61	09 0137 72 04	682	46
08 1080 000 000	423 - 723 - 425	64	08 3107 000 000	696	83	09 0116 300 05	423 - 723 - 425	61	09 0138 70 04	682	47
08 1124 000 001	712 - 702	27	08 3108 000 000	696	83	09 0116 320 05	423 - 723 - 425	62	09 0138 72 04	682	47
08 1200 040 025	623	70	08 3109 000 000	696	83	09 0116 370 05	423 - 723 - 425	62	09 0139 70 05	682	46
08 1200 050 025	623	70	08 3110 000 000	696	83	09 0116 700 05	423 - 723 - 425	61	09 0139 72 05	682	46
08 1200 050 032	623	70	08 3111 000 000	696	83	09 0116 702 05	423 - 723 - 425	62	09 0140 70 05	682	47
08 1200 060 032	623	70	08 3128 000 000	M12	141	09 0116 780 05	423 - 723 - 425	62	09 0140 72 05	682	47
08 1200 060 036	623	70	08 3129 000 000	M12	141	09 0116 782 05	423 - 723 - 425	62	09 0143 70 06	682	46
08 1200 060 038	623	70	08 3130 000 000	768 - 718	109	09 0116 80 05	423 - 723 - 425	61	09 0143 72 06	682	46
08 1200 060 041	623	70	08 3186 000 000	696	83	09 0116 90 05	423 - 723 - 425	61	09 0144 70 06	682	47
08 1200 075 036	623	70	08 3232 000 000	696	83	09 0121 25 06	723	58	09 0144 72 06	682	47
08 1200 075 038	623	70	08 3274 000 000	696	83	09 0121 70 06	723	58	09 0145 70 07	682	46
08 1200 075 041	623	70	09 0073 00 02	711	18	09 0122 25 06	723	58	09 0145 72 07	682	46
08 1200 075 046	623	70	09 0073 20 02	711	18	09 0122 70 06	723	58	09 0146 70 07	682	47
08 1200 075 052	623	70	09 0074 00 02	711	19	09 0123 00 06	423 - 723 - 425	59	09 0146 72 07	682	47
08 1200 075 055	623	70	09 0074 20 02	711	19	09 0123 290 06	423 - 723 - 425	59	09 0147 70 12	682	46
08 1200 085 046	623	70	09 0077 00 03	711	18	09 0123 300 06	423 - 723 - 425	59	09 0147 72 12	682	46
08 1200 085 052	623	70	09 0077 20 03	711	18	09 0123 320 06	423 - 723 - 425	60	09 0148 70 12	682	47
08 1200 085 055	623	70	09 0078 00 03	711	19	09 0123 370 06	423 - 723 - 425	60	09 0148 72 12	682	47
08 1200 100 052	623	70	09 0078 20 03	711	19	09 0123 700 06	423 - 723 - 425	59	09 0153 70 08	682	46
08 1200 100 055	623	70	09 0081 00 04	711	18	09 0123 702 06	423 - 723 - 425	60	09 0153 72 08	682	46
08 1200 100 062	623	70	09 0081 20 04	711	18	09 0123 780 06	423 - 723 - 425	60	09 0154 70 08	682	47
08 1200 100 066	623	7									



# Index

Part number	Series	Page	Part number	Series	Page	Part number	Series	Page	Part number	Series	Page
09 0173 00 08	423 - 723 - 425	59	09 0324 00 06	680	50	09 0412 35 04	712 - 702	25	09 0474 702 08	680	51
09 0173 290 08	423 - 723 - 425	59	09 0324 290 06	680	50	09 0412 80 04	712 - 702	25	09 0474 780 08	680	50
09 0173 300 08	423 - 723 - 425	59	09 0324 700 06	680	50	09 0412 90 04	712 - 702	25	09 0474 782 08	680	51
09 0173 320 08	423 - 723 - 425	60	09 0324 702 06	680	51	09 0415 00 05	712 - 702	24	09 0474 80 08	680	50
09 0173 370 08	423 - 723 - 425	60	09 0324 780 06	680	50	09 0415 30 05	712 - 702	24	09 0474 90 08	680	50
09 0173 65 08	423 - 723 - 425	60	09 0324 782 06	680	51	09 0415 35 05	712 - 702	24	09 0477 00 07	711	18
09 0173 700 08	423 - 723 - 425	59	09 0324 80 06	680	50	09 0415 80 05	712 - 702	24	09 0477 22 07	711	18
09 0173 702 08	423 - 723 - 425	60	09 0324 90 06	680	50	09 0415 90 05	712 - 702	24	09 0477 65 07	711	19
09 0173 780 08	423 - 723 - 425	60	09 0325 00 07	680	46	09 0416 00 05	712 - 702	25	09 0478 00 07	711	19
09 0173 782 08	423 - 723 - 425	60	09 0325 02 07	680	46	09 0416 30 05	712 - 702	25	09 0478 22 07	711	19
09 0173 80 08	423 - 723 - 425	59	09 0326 00 07	680	47	09 0416 35 05	712 - 702	25	09 0478 65 07	711	19
09 0173 90 08	423 - 723 - 425	59	09 0326 02 07	680	47	09 0416 55 05	712 - 702	25	09 0481 00 08	711	18
09 0174 00 08	423 - 723 - 425	61	09 0327 00 07	680	48	09 0416 80 05	712 - 702	25	09 0481 22 08	711	18
09 0174 290 08	423 - 723 - 425	61	09 0327 65 07	680	49	09 0416 90 05	712 - 702	25	09 0481 65 08	711	19
09 0174 300 08	423 - 723 - 425	61	09 0327 700 07	680	48	09 0423 00 07	712 - 702	24	09 0482 00 08	711	19
09 0174 320 08	423 - 723 - 425	62	09 0327 702 07	680	49	09 0423 30 07	712 - 702	24	09 0482 22 08	711	19
09 0174 370 08	423 - 723 - 425	62	09 0327 780 07	680	48	09 0423 35 07	712 - 702	24	09 0482 65 08	711	19
09 0174 65 08	423 - 723 - 425	62	09 0327 782 07	680	49	09 0423 65 07	712 - 702	24	09 0484 600 08	713 - 763	139
09 0174 700 08	423 - 723 - 425	61	09 0327 80 07	680	48	09 0423 80 07	712 - 702	24	09 0484 601 08	713 - 763	139
09 0174 702 08	423 - 723 - 425	62	09 0327 90 07	680	48	09 0423 90 07	712 - 702	24	09 0507 300 16	423 - 723 - 425	59
09 0174 780 08	423 - 723 - 425	62	09 0328 00 07	680	50	09 0424 00 07	712 - 702	25	09 0508 300 16	423 - 723 - 425	61
09 0174 782 08	423 - 723 - 425	62	09 0328 290 07	680	50	09 0424 30 07	712 - 702	25	09 0571 00 08	680	46
09 0174 80 08	423 - 723 - 425	61	09 0328 65 07	680	51	09 0424 35 07	712 - 702	25	09 0571 02 08	680	46
09 0174 90 08	423 - 723 - 425	61	09 0328 700 07	680	50	09 0424 65 07	712 - 702	24	09 0572 00 08	680	47
09 0305 00 03	680	46	09 0328 702 07	680	51	09 0424 80 07	712 - 702	25	09 0572 02 08	680	47
09 0305 02 03	680	46	09 0328 780 07	680	50	09 0424 90 07	712 - 702	25	09 0631 070 04	813	190
09 0306 00 03	680	47	09 0328 782 07	680	51	09 0427 00 08	712 - 702	24	09 0631 120 04	813	189
09 0306 02 03	680	47	09 0328 80 07	680	50	09 0427 30 08	712 - 702	24	09 0631 300 04	813	189
09 0307 00 03	680	48	09 0328 90 07	680	50	09 0427 35 08	712 - 702	24	09 0631 320 04	813	189
09 0307 80 03	680	48	09 0329 00 12	680	46	09 0427 65 08	712 - 702	24	09 0631 642 04	813	190
09 0307 90 03	680	48	09 0329 02 12	680	46	09 0427 80 08	712 - 702	24	09 0631 700 04	813	189
09 0308 00 03	680	50	09 0330 00 12	680	47	09 0427 90 08	712 - 702	24	09 0631 90 04	813	189
09 0308 290 03	680	50	09 0330 02 12	680	47	09 0428 00 08	712 - 702	25	09 0632 070 04	813	192
09 0308 80 03	680	50	09 0331 00 12	680	48	09 0428 30 08	712 - 702	25	09 0632 120 04	813	191
09 0308 90 03	680	50	09 0331 290 12	680	48	09 0428 35 08	712 - 702	25	09 0632 300 04	813	191
09 0309 00 04	680	46	09 0331 65 12	680	49	09 0428 65 08	712 - 702	24	09 0632 321 04	813	191
09 0309 02 04	680	46	09 0331 66 12	680	49	09 0428 80 08	712 - 702	25	09 0632 642 04	813	192
09 0310 00 04	680	47	09 0331 80 12	680	48	09 0428 90 08	712 - 702	25	09 0632 700 04	813	191
09 0310 02 04	680	47	09 0331 90 12	680	48	09 0431 397 04	713 - 763	129	09 0632 90 04	813	191
09 0311 00 04	680	48	09 0332 00 12	680	50	09 0431 600 04	713 - 763	133	09 0687 700 03	814	182
09 0311 700 04	680	48	09 0332 290 12	680	50	09 0431 601 04	713 - 763	133	09 0688 700 03	814	184
09 0311 702 04	680	49	09 0332 65 12	680	51	09 0431 81 04	713 - 763	129	09 0691 070 04	814	183
09 0311 780 04	680	48	09 0332 66 12	680	51	09 0431 90 04	715 - 766	161	09 0691 121 04	814	182
09 0311 782 04	680	49	09 0332 80 12	680	50	09 0432 600 04	713 - 763	139	09 0691 300 04	814	182
09 0311 80 04	680	48	09 0332 90 12	680	50	09 0432 601 04	713 - 763	139	09 0691 300 04	814	184
09 0311 90 04	680	48	09 0335 00 19	680	48	09 0433 600 05	713 - 763	133	09 0691 320 04	814	182
09 0312 00 04	680	50	09 0335 80 19	680	48	09 0433 601 05	713 - 763	133	09 0691 320 04	814	184
09 0312 290 04	680	50	09 0335 90 19	680	48	09 0433 81 05	713 - 763	129	09 0691 642 04	814	182
09 0312 700 04	680	50	09 0336 00 19	680	50	09 0434 600 05	713 - 763	139	09 0691 700 04	814	182
09 0312 702 04	680	51	09 0336 80 19	680	50	09 0434 601 05	713 - 763	139	09 0692 070 04	814	185
09 0312 780 04	680	50	09 0336 90 19	680	50	09 0435 87 04	713 - 763	129	09 0692 121 04	814	184
09 0312 782 04	680	51	09 0343 00 19	680	46	09 0435 90 04	715 - 766	161	09 0692 642 04	814	184
09 0312 80 04	680	50	09 0343 02 19	680	46	09 0437 87 05	713 - 763	129	09 0692 700 04	814	184
09 0312 90 04	680	50	09 0344 00 19	680	47	09 0439 397 04	713 - 763	129	09 0731 601 04	825	172
09 0313 00 05	680	46	09 0344 02 19	680	47	09 0442 601 04	715 - 766	165	09 0732 601 04	825	174
09 0313 02 05	680	46	09 0381 600 08	713 - 763	133	09 0443 601 04	715 - 766	163	09 0774 000 08	770	38
09 0314 00 05	680	47	09 0381 601 08	713 - 763	133	09 0444 601 05	715 - 766	165	09 0774 090 08	770	39
09 0314 02 05	680	47	09 0381 81 08	713 - 763	129	09 0445 601 05	715 - 766	163	09 0774 180 08	770	38
09 0315 00 05	680	48	09 0403 00 02	712 - 702	24	09 0453 300 14	423 - 723 - 425	59	09 0774 190 08	770	39
09 0315 290 05	680	48	09 0403 30 02	712 - 702	24	09 0454 300 14	423 - 723 - 425	61	09 0774 400 08	770	92
09 0315 700 05	680	48	09 0403 35 02	712 - 702	24	09 0461 25 19	723	58	09 0774 490 08	770	92
09 0315 702 05	680	49	09 0403 80 02	712 - 702	24	09 0461 70 19	723	58	09 0973 00 02	710	12
09 0315 780 05	680	48	09 0403 90 02	712 - 702	24	09 0462 25 19	723	58	09 0974 00 02	710	12
09 0315 782 05	680	49	09 0404 00 02	712 - 702	25	09 0462 70 19	723	58	09 0977 00 03	710	12
09 0315 80 05	680	48	09 0404 30 02	712 - 702	25	09 0463 00 19	423 - 723 - 425	59	09 0978 00 03	710	12
09 0315 90 05	680	48	09 0404 35 02	712 - 702	25	09 0463 290 19	423 - 723 - 425	59	09 0981 00 04	710	12
09 0316 00 05	680	50	09 0404 55 02	712 - 702	25	09 0463 300 19	423 - 723 - 425	59	09 0982 00 04	710	12
09 0316 290 05	680	50	09 0404 80 02	712 - 702	25	09 0463 80 19	423 - 723 - 425	59	09 0997 00 05	710	12
09 0316 700 05	680	50	09 0404 90 02	712 - 702	25	09 0463 90 19	423 - 723 - 425	59	09 0998 00 05	710	12
09 0316 702 05	680	51	09 0407 00 03	712 - 702	24	09 0464 00 19	423 - 723 - 425	61	09 2446 100 03	820 - 870	198
09 0316 780 05	680	50	09 0407 30 03	712 - 702	24	09 0464 300 19	423 - 723 - 425	61	09 2446 180 03	820 - 870	198
09 0316 782 05	680	51	09 0407 35 03	712 - 702	24	09 0464 80 19	423 - 723 - 425	61	09 2446 300 03	820 - 870	198
09 0316 80 05	680	50	09 0407 80 03	712 - 702	24	09 0464 90 19	423 - 723 - 425	61	09 2446 310 03	820 - 870	198
09 0316 90 05	680	50	09 0407 90 03	712 - 702	24	09 0473 00 08	680	48	09 2446 320 03	820 - 870	198
09 0321 00 06	680	46	09 0408 00 03	712 - 702	25	09 0473 290 08	680	48	09 2446 330 03	820 - 870	198
09 0321 02 06	680	46	09 0408 30 03	712 - 702	25	09 0473 65 08	680	49	09 2447 100 03	820 - 870	197
09 0322 00 06	680	47	09 0408 35 03	712 - 702	25	09 0473 700 08	680	48	09 2447 180 03	820 - 870	197
09 0322 02 06	680	47	09 0408 80 03	712 - 702	25	09 0473 702 08	680	49	09 2447 300 03	820 - 870	197
09 0323 00 06	680	48	09 0408 90 03	712 - 702	25	09 0473 780 08	680	48	09 2447 310 03	820 - 870	197
09 0323 290 06	680	48	09 0411 00 04	712 - 702	24	09 0473 782 08	680	49	09 2447 320 03	820 - 870	197
09 0323 700 06	680	48	09 0411 30 04	712 - 702	24	09 0473 80 08	680	48	09 2447 330 03	820 - 870	197
09 0323 702 06	680	49	09 0411 35								

# Index

Part number	Series	Page	Part number	Series	Page	Part number	Series	Page	Part number	Series	Page
09 2448 330 04	820 - 870	198	09 3423 00 06	768 - 718	106	09 4816 15 05	440	41	09 4928 00 07	430	17
09 2449 100 04	820 - 870	197	09 3423 81 06	768 - 718	106	09 4816 25 05	440	41	09 4928 015 07	430	17
09 2449 180 04	820 - 870	197	09 3423 82 06	768 - 718	106	09 4816 80 05	440	41	09 4928 080 07	430	17
09 2449 300 04	820 - 870	197	09 3423 86 06	768 - 718	106	09 4816 81 05	440	41	09 4928 081 07	430	17
09 2449 310 04	820 - 870	197	09 3424 00 05	768 - 718	107	09 4819 00 06	440	40	09 4931 00 08	430	16
09 2449 320 04	820 - 870	197	09 3424 81 05	768 - 718	107	09 4819 15 06	440	40	09 4931 015 08	430	16
09 2449 330 04	820 - 870	197	09 3424 82 05	768 - 718	107	09 4819 25 06	440	40	09 4931 025 08	430	16
09 2450 100 05	820 - 870	198	09 3424 86 05	768 - 718	107	09 4819 80 06	440	40	09 4931 080 08	430	16
09 2450 180 05	820 - 870	198	09 3425 00 05	768 - 718	106	09 4819 81 06	440	40	09 4931 081 08	430	16
09 2450 300 05	820 - 870	198	09 3425 81 05	768 - 718	106	09 4820 00 06	440	41	09 4932 00 08	430	17
09 2450 310 05	820 - 870	198	09 3425 82 05	768 - 718	106	09 4820 15 06	440	41	09 4932 015 08	430	17
09 2450 320 05	820 - 870	198	09 3425 86 05	768 - 718	106	09 4820 25 06	440	41	09 4932 025 08	430	17
09 2450 330 05	820 - 870	198	09 3426 00 08	768 - 718	107	09 4820 80 06	440	41	09 4932 080 08	430	17
09 2451 100 05	820 - 870	197	09 3426 81 08	768 - 718	107	09 4820 81 06	440	41	09 4932 081 08	430	17
09 2451 180 05	820 - 870	197	09 3426 86 08	768 - 718	107	09 4827 00 07	440	40	09 5240 00 04	765	151
09 2451 300 05	820 - 870	197	09 3427 00 08	768 - 718	106	09 4827 15 07	440	40	09 5241 00 05	765	151
09 2451 310 05	820 - 870	197	09 3427 81 08	768 - 718	106	09 4827 25 07	440	40	09 5242 00 04	715 - 766	165
09 2451 320 05	820 - 870	197	09 3427 86 08	768 - 718	106	09 4827 80 07	440	40	09 5244 00 08	765	151
09 2451 330 05	820 - 870	197	09 3431 284 04	713 - 763	131	09 4827 81 07	440	40	09 5245 00 04	825	174
09 2472 00 05	820 - 870	197	09 3431 433 04	713 - 763	130	09 4828 00 07	440	41	09 5246 00 04	825	174
09 2473 100 03	820 - 870	197	09 3432 284 04	713 - 763	136	09 4828 15 07	440	41	09 5250 00 03	765	151
09 2474 100 04	820 - 870	197	09 3432 433 04	713 - 763	136	09 4828 25 07	440	41	09 5251 00 04	765	151
09 2475 100 05	820 - 870	197	09 3432 92 04	713 - 763	138	09 4828 80 07	440	41	09 5280 00 03	765	151
09 3105 00 03	707	95	09 3441 433 05	713 - 763	130	09 4828 81 07	440	41	09 5281 00 04	765	151
09 3105 01 03	707	95	09 3442 433 05	713 - 763	136	09 4831 00 08	440	40	09 5283 00 03	765	151
09 3105 81 03	707	95	09 3442 92 05	713 - 763	138	09 4831 15 08	440	40	09 5284 00 04	765	151
09 3105 86 03	707	95	09 3462 00 06	768 - 718	107	09 4831 25 08	440	40	09 5286 00 08	876	178
09 3106 00 03	707	95	09 3462 80 06	768 - 718	107	09 4831 80 08	440	40	09 6503 000 08	696	80
09 3106 01 03	707	95	09 3462 86 06	768 - 718	107	09 4831 81 08	440	40	09 6504 000 08	696	80
09 3106 81 03	707	95	09 3463 00 06	768 - 718	105	09 4832 00 08	440	41	09 6519 000 12	696	80
09 3106 86 03	707	95	09 3463 81 06	768 - 718	106	09 4832 15 08	440	41	09 6520 000 12	696	80
09 3111 00 04	707	95	09 3463 86 06	768 - 718	105	09 4832 25 08	440	41	09 9477 00 07	710	12
09 3111 01 04	707	95	09 3486 00 08	768 - 718	107	09 4832 80 08	440	41	09 9478 00 07	710	12
09 3111 71 04	707	96	09 3486 80 08	768 - 718	107	09 4832 81 08	440	41	09 9481 00 08	710	12
09 3111 81 04	707	95	09 3486 86 08	768 - 718	107	09 4835 00 12	440	40	09 9482 00 08	710	12
09 3111 86 04	707	95	09 3487 00 08	768 - 718	105	09 4835 15 12	440	40	09 9618 100 05	712 - 702	27
09 3112 00 04	707	95	09 3487 81 08	768 - 718	106	09 4835 25 12	440	40	09 9747 00 03	719	6
09 3112 01 04	707	95	09 3487 86 08	768 - 718	105	09 4835 80 12	440	40	09 9747 70 03	719	6
09 3112 81 04	707	95	09 3782 200 08	876	178	09 4835 81 12	440	40	09 9747 71 03	719	6
09 3112 86 04	707	95	09 3782 202 08	876	178	09 4836 00 12	440	41	09 9748 00 03	719	6
09 3389 70 04	768 - 718	105	09 3782 91 08	825 - 876	177	09 4836 15 12	440	41	09 9748 70 03	719	6
09 3390 00 04	768 - 718	107	09 3782 95 08	825 - 876	177	09 4836 25 12	440	41	09 9748 71 03	719	6
09 3390 186 04	768 - 718	107	09 4203 00 07	693	76	09 4836 80 12	440	41	09 9749 20 03	709 - 719	7
09 3390 187 04	768 - 718	107	09 4204 00 07	693	77	09 4836 81 12	440	41	09 9749 30 03	709 - 719	7
09 3390 80 04	768 - 718	107	09 4219 00 07	693	76	09 4843 00 19	440	40	09 9750 20 03	709 - 719	7
09 3390 86 04	768 - 718	107	09 4219 150 07	693	76	09 4843 15 19	440	40	09 9750 30 03	709 - 719	7
09 3391 00 04	768 - 718	105	09 4220 00 07	693	77	09 4843 25 19	440	40	09 9764 00 04	719	6
09 3391 81 04	768 - 718	106	09 4220 150 07	693	77	09 4843 80 19	440	40	09 9764 70 04	719	6
09 3391 86 04	768 - 718	105	09 4223 00 04	693	76	09 4843 81 19	440	40	09 9764 71 04	719	6
09 3403 00 03	768 - 718	105	09 4223 150 04	693	76	09 4844 00 19	440	41	09 9765 20 04	709 - 719	7
09 3403 81 03	768 - 718	106	09 4224 00 04	693	77	09 4844 15 19	440	41	09 9765 30 04	709 - 719	7
09 3403 86 03	768 - 718	105	09 4224 150 04	693	77	09 4844 25 19	440	41	09 9766 20 04	709 - 719	7
09 3411 70 03	768 - 718	105	09 4227 00 07	693	76	09 4844 80 19	440	41	09 9766 30 04	709 - 719	7
09 3412 00 03	768 - 718	107	09 4228 00 07	693	77	09 4844 81 19	440	41	09 9767 00 04	719	6
09 3412 186 03	768 - 718	107	09 4707 00 03	420	14	09 4907 00 03	430	16	09 9767 70 04	719	6
09 3412 187 03	768 - 718	107	09 4708 00 03	420	14	09 4907 015 03	430	16	09 9767 71 04	719	6
09 3412 80 03	768 - 718	107	09 4711 00 04	420	14	09 4907 025 03	430	16	09 9789 00 05	719	6
09 3412 86 03	768 - 718	107	09 4712 00 04	420	14	09 4907 080 03	430	16	09 9789 71 05	719	6
09 3413 00 03	768 - 718	105	09 4715 00 05	420	14	09 4907 081 03	430	16	09 9790 00 05	719	6
09 3413 150 03	768 - 718	105	09 4716 00 05	420	14	09 4908 00 03	430	17	09 9790 71 05	719	6
09 3413 40 03	768 - 718	105	09 4807 00 03	440	40	09 4908 015 03	430	17	09 9791 20 05	709 - 719	7
09 3413 41 03	768 - 718	105	09 4807 15 03	440	40	09 4908 025 03	430	17	09 9791 30 05	709 - 719	7
09 3415 00 04	768 - 718	105	09 4807 25 03	440	40	09 4908 080 03	430	17	09 9792 20 05	709 - 719	7
09 3415 150 04	768 - 718	105	09 4807 80 03	440	40	09 4908 081 03	430	17	09 9792 30 05	709 - 719	7
09 3415 40 04	768 - 718	105	09 4807 81 03	440	40	09 4911 00 04	430	16	16 0401 001	M12	142
09 3415 41 04	768 - 718	105	09 4808 00 03	440	41	09 4911 015 04	430	16	16 0401 001	820 - 870	199
09 3418 00 03	768 - 718	107	09 4808 15 03	440	41	09 4911 025 04	430	16	16 0402 001	M12	142
09 3418 81 03	768 - 718	107	09 4808 25 03	440	41	09 4911 081 04	430	16	16 0403 001	M12	142
09 3418 82 03	768 - 718	107	09 4808 80 03	440	41	09 4912 00 04	430	17	16 0403 001	820 - 870	199
09 3418 86 03	768 - 718	107	09 4808 81 03	440	41	09 4912 015 04	430	17	16 0565 00 00	693	79
09 3419 00 03	768 - 718	106	09 4811 00 04	440	40	09 4912 025 04	430	17	16 0566 00 00	693	79
09 3419 81 03	768 - 718	106	09 4811 15 04	440	40	09 4912 080 04	430	17	16 0916 001	M12	142
09 3419 82 03	768 - 718	106	09 4811 25 04	440	40	09 4912 081 04	430	17	16 0917 001	M12	142
09 3419 86 03	768 - 718	106	09 4811 80 04	440	40	09 4915 00 05	430	16	16 0917 001	820 - 870	199
09 3420 00 04	768 - 718	107	09 4811 81 04	440	40	09 4915 015 05	430	16	16 0959 000	M12	142
09 3420 81 04	768 - 718	107	09 4812 00 04	440	41	09 4915 080 05	430	16	16 0977 000	M12	142
09 3420 82 04	768 - 718	107	09 4812 15 04	440	41	09 4915 081 05	430	16	16 1125 071	M12	142
09 3420 86 04	768 - 718	107	09 4812 25 04	440	41	09 4916 00 05	430	17	16 8085 000	210	204
09 3421 00 04	768 - 718	106	09 4812 80 04	440	41	09 4916 015 05	430	17	16 8085 001	210	204
09 3421 81 04	768 - 718	106	09 4812 81 04	440	41	09 4916 025 05	430	17	16 8088 000	210	204
09 3421 82 04	768 - 718	106	09 4815 00 05	440	40	09 4916 080 05	430	17	16 8089 000	210	204
09 3421 86 04	768 - 718	106	09 4815 15 05	440	40	09 4916 081 05	430	17	16 8089 001	210	204
09 3422 00 06	768 - 718	107	09 4815 25 05	440	40	09 4927 015 07	430	16	16 8090 000	210	204
09 3422 81 06	768 - 718	107	09 4815 80 05	440	40</						

# Index

Part number	Series	Page	Part number	Series	Page	Part number	Series	Page	Part number	Series	Page
16 8092 001	210	204	43 1717 024 03	210	203	61 1155 146	M12	143	65 0797 085 10	581 - 680 - 682	52
16 8093 000	220	209	43 1717 025 03	210	203	61 1155 146	715	160	65 0797 085 10	423 - 723 - 425	63
16 8093 001	220	209	43 1719 026 04	210	203	61 1224 146	713	112	65 0797 085 10	696	82
16 8094 000	220	209	43 1719 027 04	210	203	61 1224 146	M12	143	65 0797 098 01	581 - 680 - 682	52
16 8094 001	220	209	43 1719 028 04	210	203	61 1224 146	715	160	65 0797 098 01	423 - 723 - 425	63
16 8096 131	210	204	43 1719 029 04	210	203	61 1224 146	825	170	65 0797 098 01	696	82
16 8096 131	220	209	43 1719 030 04	210	203	61 1225 146	713	112	65 0797 098 02	581 - 680 - 682	52
16 8097 000	230	212	43 1726 110 03	210	201	61 1225 146	M12	143	65 0797 098 02	423 - 723 - 425	63
16 8100 000	220	209	43 1726 112 03	210	201	61 1225 146	715	160	65 0797 098 02	696	82
16 8100 001	220	209	43 1730 140 03	210	201	61 1225 146	825	170	65 0797 098 04	581 - 680 - 682	52
16 8101 000	220	209	43 1730 142 03	210	201	61 1226 146	713	112	65 0797 098 04	423 - 723 - 425	63
16 8104 131	210	204	43 1800 000 03	220	207	61 1226 146	M12	143	65 0797 098 04	696	82
16 8105 000	220	209	43 1801 000 03	220	208	61 1226 146	715	160	65 0797 098 10	581 - 680 - 682	52
16 8106 071	230	212	43 1830 000 03	220	205	61 1226 146	825	170	65 0797 098 10	423 - 723 - 425	63
16 8107 000	230	212	43 1831 000 03	220	206	61 1227 146	713	121	65 0797 098 10	696	82
16 8107 001	230	212	43 1834 130 03	220	205	61 1227 146	M12	143	65 0798 085 01	581 - 680 - 682	52
16 8107 002	230	212	43 1834 135 03	220	205	61 1227 146	715	160	65 0798 085 01	423 - 723 - 425	63
16 8110 000	230	212	43 1900 000 03	230	211	61 1228 146	713	121	65 0798 085 01	696	82
16 8114 000	210	204	43 1900 004 03	230	211	61 1228 146	M12	143	65 0798 085 02	581 - 680 - 682	52
16 8114 000	210	204	43 1901 000 03	230	211	61 1228 146	715	160	65 0798 085 02	423 - 723 - 425	63
30 5535 300 000	220	205	43 1902 000 04	230	211	61 1229 146	713	121	65 0798 085 02	696	82
30 5535 500 000	220	205	43 1902 004 04	230	211	61 1229 146	M12	143	65 0798 085 04	581 - 680 - 682	52
30 5537 300 510	220	205	43 1903 000 04	230	211	61 1229 146	715	160	65 0798 085 04	423 - 723 - 425	63
30 5537 500 510	220	205	43 1905 000 03	230	211	61 1285 139	696	82	65 0798 085 04	696	82
30 5539 300 520	220	205	43 1907 000 04	230	211	61 1286 139	696	82	65 0798 085 10	581 - 680 - 682	52
30 5539 500 520	220	205	43 1930 000 03	230	210	61 1310 139	696	82	65 0798 085 10	423 - 723 - 425	63
31 5234 300 000	210	202	43 1930 004 03	230	210	61 1311 139	696	82	65 0798 085 10	696	82
31 5234 500 000	210	202	43 1932 000 04	230	210	61 1312 139	696	82	65 0798 098 01	581 - 680 - 682	52
31 5235 300 000	210	202	43 1932 004 04	230	210	61 1313 139	696	82	65 0798 098 01	423 - 723 - 425	63
31 5235 500 000	210	202	61 0795 085 00	581 - 680 - 682	52	65 0795 085 01	581 - 680 - 682	52	65 0798 098 01	696	82
31 5236 300 510	210	202	61 0795 085 00	423 - 723 - 425	63	65 0795 085 01	423 - 723 - 425	63	65 0798 098 02	581 - 680 - 682	52
31 5236 500 510	210	202	61 0795 085 00	696	82	65 0795 085 01	696	82	65 0798 098 02	423 - 723 - 425	63
31 5237 300 520	210	202	61 0795 098 00	581 - 680 - 682	52	65 0795 085 02	581 - 680 - 682	52	65 0798 098 02	696	82
31 5237 500 520	210	202	61 0795 098 00	423 - 723 - 425	63	65 0795 085 02	423 - 723 - 425	63	65 0798 098 04	581 - 680 - 682	52
32 5335 300 000	220	207	61 0795 098 00	696	82	65 0795 085 02	696	82	65 0798 098 04	423 - 723 - 425	63
32 5335 500 000	220	207	61 0796 085 00	581 - 680 - 682	52	65 0795 085 04	581 - 680 - 682	52	65 0798 098 04	696	82
32 5337 300 510	220	207	61 0796 085 00	423 - 723 - 425	63	65 0795 085 04	423 - 723 - 425	63	65 0798 098 10	581 - 680 - 682	52
32 5337 500 510	220	207	61 0796 085 00	696	82	65 0795 085 04	696	82	65 0798 098 10	423 - 723 - 425	63
32 5339 300 520	220	207	61 0796 098 00	581 - 680 - 682	52	65 0795 085 10	581 - 680 - 682	52	65 0799 085 01	581 - 680 - 682	52
32 5339 500 520	220	207	61 0796 098 00	423 - 723 - 425	63	65 0795 085 10	423 - 723 - 425	63	65 0799 085 01	423 - 723 - 425	63
33 5934 300 000	230	210	61 0796 098 00	696	82	65 0795 085 10	696	82	65 0799 085 01	696	82
33 5934 500 000	230	210	61 0797 085 00	581 - 680 - 682	52	65 0795 098 01	581 - 680 - 682	52	65 0799 085 02	581 - 680 - 682	52
33 5937 300 520	230	210	61 0797 085 00	423 - 723 - 425	63	65 0795 098 01	423 - 723 - 425	63	65 0799 085 02	423 - 723 - 425	63
33 5937 500 520	230	210	61 0797 085 00	696	82	65 0795 098 01	696	82	65 0799 085 02	423 - 723 - 425	63
34 5734 300 000	230	211	61 0797 098 00	581 - 680 - 682	52	65 0795 098 02	581 - 680 - 682	52	65 0799 085 02	696	82
34 5734 500 000	230	211	61 0797 098 00	423 - 723 - 425	63	65 0795 098 02	423 - 723 - 425	63	65 0799 085 04	581 - 680 - 682	52
34 5737 300 520	230	211	61 0797 098 00	696	82	65 0795 098 02	696	82	65 0799 085 04	423 - 723 - 425	63
34 5737 500 520	230	211	61 0798 085 00	581 - 680 - 682	52	65 0795 098 04	581 - 680 - 682	52	65 0799 085 04	696	82
43 1700 000 03	210	200	61 0798 085 00	423 - 723 - 425	63	65 0795 098 04	423 - 723 - 425	63	65 0799 085 10	581 - 680 - 682	52
43 1700 002 03	210	200	61 0798 085 00	696	82	65 0795 098 04	696	82	65 0799 085 10	423 - 723 - 425	63
43 1700 004 03	210	200	61 0798 098 00	581 - 680 - 682	52	65 0795 098 10	581 - 680 - 682	52	65 0799 085 10	696	82
43 1701 000 03	210	203	61 0798 098 00	423 - 723 - 425	63	65 0795 098 10	423 - 723 - 425	63	65 0799 098 01	581 - 680 - 682	52
43 1702 000 04	210	200	61 0798 098 00	696	82	65 0795 098 10	696	82	65 0799 098 01	423 - 723 - 425	63
43 1702 002 04	210	200	61 0799 085 00	581 - 680 - 682	52	65 0796 085 01	581 - 680 - 682	52	65 0799 098 01	696	82
43 1702 004 04	210	200	61 0799 085 00	423 - 723 - 425	63	65 0796 085 01	423 - 723 - 425	63	65 0799 098 02	581 - 680 - 682	52
43 1703 000 04	210	203	61 0799 085 00	696	82	65 0796 085 01	696	82	65 0799 098 02	423 - 723 - 425	63
43 1704 000 03	210	200	61 0799 098 00	581 - 680 - 682	52	65 0796 085 02	581 - 680 - 682	52	65 0799 098 02	696	82
43 1704 002 03	210	200	61 0799 098 00	423 - 723 - 425	63	65 0796 085 02	423 - 723 - 425	63	65 0799 098 04	581 - 680 - 682	52
43 1704 004 03	210	200	61 0799 098 00	696	82	65 0796 085 02	696	82	65 0799 098 04	423 - 723 - 425	63
43 1705 005 03	210	203	61 0800 085 00	581 - 680 - 682	52	65 0796 085 04	581 - 680 - 682	52	65 0799 098 04	696	82
43 1706 000 04	210	200	61 0800 085 00	423 - 723 - 425	63	65 0796 085 04	423 - 723 - 425	63	65 0799 098 10	581 - 680 - 682	52
43 1706 002 04	210	200	61 0800 085 00	696	82	65 0796 085 04	696	82	65 0799 098 10	423 - 723 - 425	63
43 1706 004 04	210	200	61 0800 098 00	581 - 680 - 682	52	65 0796 085 10	581 - 680 - 682	52	65 0799 098 10	696	82
43 1707 005 04	210	203	61 0800 098 00	423 - 723 - 425	63	65 0796 085 10	423 - 723 - 425	63	65 0800 085 01	581 - 680 - 682	52
43 1707 019 04	210	203	61 0800 098 00	696	82	65 0796 085 10	696	82	65 0800 085 01	423 - 723 - 425	63
43 1708 011 00	210	200	61 0891 139	696	82	65 0796 098 01	581 - 680 - 682	52	65 0800 085 01	696	82
43 1708 012 00	210	200	61 0892 139	696	82	65 0796 098 01	423 - 723 - 425	63	65 0800 085 02	581 - 680 - 682	52
43 1708 013 00	210	200	61 0893 139	696	82	65 0796 098 01	696	82	65 0800 085 02	423 - 723 - 425	63
43 1708 014 00	210	200	61 0894 139	696	82	65 0796 098 02	581 - 680 - 682	52	65 0800 085 02	696	82
43 1708 015 00	210	200	61 0896 139	693	78	65 0796 098 02	423 - 723 - 425	63	65 0800 085 04	581 - 680 - 682	52
43 1708 016 00	210	200	61 0896 139	696	82	65 0796 098 02	696	82	65 0800 085 04	423 - 723 - 425	63
43 1708 017 00	210	200	61 0897 139	693	78	65 0796 098 04	581 - 680 - 682	52	65 0800 085 04	696	82
43 1708 018 00	210	200	61 0897 139	696	82	65 0796 098 04	423 - 723 - 425	63	65 0800 085 10	581 - 680 - 682	52
43 1709 000 03	210	203	61 0898 139	693	78	65 0796 098 04	696	82	65 0800 085 10	423 - 723 - 425	63
43 1711 000 04	210	203	61 0898 139	696	82	65 0796 098 10	581 - 680 - 682	52	65 0800 085 10	696	82
43 1713 000 03	210	203	61 0899 139	693	78	65 0796 098 10	423 - 723 - 425	63	65 0800 098 01	581 - 680 - 682	52
43 1714 131 03	210	201	61 0899 139	696	82	65 0796 098 10	696	82	65 0800 098 01	423 - 723 - 425	63
43 1714 132 03	210	201	61 0900 139	696	82	65 0797 085 01	581 - 680 - 682	52	65 0800 098 01	696	82
43 1714 133 03	210	201	61 0901 139	696	82	65 0797 085 01	423 - 723 - 425	63	65 0800 098 02	581 - 680 -	

# Index

Part number	Series	Page	Part number	Series	Page	Part number	Series	Page	Part number	Series	Page
65 0800 098 10	696	82	76 0236 0011 00404-0200	825	173	76 2532 1111 00004-0200	713 - 763	137	77 1434 0000 50005-0200	870	194
66 0001 014 100	581 - 680 - 682	53	76 0331 0111 00004-0200	713 - 763	131	76 2532 1111 00005-0200	713 - 763	137	77 1434 0000 50005-0500	870	194
66 0001 014 100	423 - 723 - 425	65	76 0331 0111 00005-0200	713 - 763	131	76 2532 1111 00008-0200	713 - 763	137	77 1434 0000 50005-1000	870	194
66 0001 014 100	696	83	76 0331 0111 00008-0200	713 - 763	131	76 2731 0111 00004-0200	713 - 763	131	77 2529 0000 50705-0200	763	117
66 0003 001	693	79	76 0331 0111 00012-0200	713 - 763	131	76 2731 0111 00005-0200	713 - 763	131	77 2529 0000 50705-0500	763	117
66 0003 001	696	83	76 0431 0111 00004-0200	713 - 763	131	76 2731 0111 00008-0200	713 - 763	131	77 2529 0000 50705-1000	763	117
66 0003 001	M12	144	76 0431 0111 00005-0200	713 - 763	131	76 2732 0111 00004-0200	713 - 763	137	77 2530 0000 50705-0200	763	125
66 0004 001	693	79	76 0431 0111 00008-0200	713 - 763	131	76 2732 0111 00005-0200	713 - 763	137	77 2530 0000 50705-0500	763	125
66 0004 001	696	83	76 0431 0111 00012-0200	713 - 763	131	76 2732 0111 00008-0200	713 - 763	137	77 2530 0000 50705-1000	763	125
66 0004 001	M12	144	76 0432 0111 00004-0200	713 - 763	136	76 2831 0111 00004-0200	713 - 763	131	77 3403 0000 20003-0200	718	101
66 0005 000	696	83	76 0432 0111 00005-0200	713 - 763	136	76 2831 0111 00005-0200	713 - 763	131	77 3403 0000 20003-0500	718	101
66 0011 001	696	83	76 0432 0111 00008-0200	713 - 763	136	76 2831 0111 00008-0200	713 - 763	131	77 3403 0000 20004-0200	718	101
66 0012 001	696	83	76 0432 0111 00012-0200	713 - 763	136	76 2832 0111 00004-0200	713 - 763	137	77 3403 0000 20004-0500	718	101
67 0001 014 100	581 - 680 - 682	53	76 0531 1011 00004-0200	713 - 763	131	76 2832 0111 00005-0200	713 - 763	137	77 3403 0000 20003-0200	718	101
67 0001 014 100	423 - 723 - 425	65	76 0531 1011 00005-0200	713 - 763	131	76 2832 0111 00008-0200	713 - 763	137	77 3403 0000 20003-0500	718	101
67 0001 014 100	696	83	76 0531 1011 00008-0200	713 - 763	131	76 4331 0011 00004-0200	713 - 763	130	77 3403 0000 20004-0200	718	101
70 3420 005 04	768 - 718	108	76 0531 1111 00012-0200	713 - 763	131	76 4331 0011 00005-0200	713 - 763	130	77 3403 0000 20004-0500	718	101
70 3421 005 04	768 - 718	106	76 0532 1011 00004-0200	713 - 763	137	76 4331 0011 00008-0200	713 - 763	130	77 3403 0000 20006-0200	718	101
70 3441 287 05	713 - 763	134	76 0532 1011 00005-0200	713 - 763	137	76 4331 0111 00012-0200	713 - 763	130	77 3403 0000 20006-0500	718	101
70 3441 785 05	713 - 763	134	76 0532 1011 00008-0200	713 - 763	137	76 4332 0011 00004-0200	713 - 763	135	77 3403 0000 20008-0200	718	101
70 3442 287 05	713 - 763	139	76 0532 1111 00012-0200	713 - 763	137	76 4332 0011 00005-0200	713 - 763	135	77 3403 0000 20008-0500	718	101
70 3442 785 05	713 - 763	139	76 0533 1011 00104-0200	715 - 766	162	76 4332 0011 00008-0200	713 - 763	135	77 3405 0000 20003-0200	718	101
70 3481 287 08	713 - 763	134	76 0533 1011 00105-0200	715 - 766	162	76 4332 0111 00012-0200	713 - 763	135	77 3405 0000 20003-0500	718	101
70 3481 785 08	713 - 763	134	76 0534 1011 00104-0200	715 - 766	164	76 4631 0011 00004-0200	713 - 763	130	77 3405 0000 20004-0200	718	101
70 3482 287 08	713 - 763	139	76 0534 1011 00105-0200	715 - 766	164	76 4631 0011 00005-0200	713 - 763	130	77 3405 0000 20004-0500	718	101
70 3482 785 08	713 - 763	139	76 0536 1011 00404-0200	825	173	76 4631 0011 00008-0200	713 - 763	130	77 3405 0000 20003-0200	718	101
70 3733 705 04	825	172	76 0631 1011 00004-0200	713 - 763	131	76 4631 0111 00012-0200	713 - 763	130	77 3405 0000 20003-0500	718	101
70 3733 706 04	825	172	76 0631 1011 00005-0200	713 - 763	131	76 4731 3011 00004-0200	713 - 763	130	77 3405 0000 20004-0200	718	101
70 3734 705 04	825	174	76 0631 1011 00008-0200	713 - 763	131	76 4731 3011 00005-0200	713 - 763	130	77 3405 0000 20004-0500	718	101
70 3734 706 04	825	174	76 0631 1015 00004-0200	713 - 763	132	76 4731 3011 00008-0200	713 - 763	130	77 3405 0000 20006-0200	718	101
70 3784 706 08	825 - 876	177	76 0631 1111 00012-0200	713 - 763	131	76 4731 3111 00012-0200	713 - 763	130	77 3405 0000 20006-0500	718	101
70 4433 246 04	715 - 766	163	76 0632 1011 00004-0200	713 - 763	137	76 4832 3011 00004-0200	713 - 763	135	77 3405 0000 20008-0200	718	101
70 4433 247 04	715 - 766	163	76 0632 1011 00005-0200	713 - 763	137	76 4832 3011 00005-0200	713 - 763	135	77 3405 0000 20008-0500	718	101
70 4434 246 04	715 - 766	165	76 0632 1011 00008-0200	713 - 763	137	76 4832 3011 00008-0200	713 - 763	135	77 3406 0000 20003-0200	718	104
70 4434 247 04	715 - 766	165	76 0632 1015 00004-0200	713 - 763	137	76 4832 3011 00008-0200	713 - 763	135	77 3406 0000 20003-0500	718	104
76 0131 0011 00004-0200	713 - 763	130	76 0632 1111 00012-0200	713 - 763	137	76 4832 3111 00012-0200	713 - 763	135	77 3406 0000 20004-0200	718	104
76 0131 0011 00005-0200	713 - 763	130	76 0731 0011 00004-0200	713 - 763	131	77 0605 0000 50704-0200	763	116	77 3406 0000 20004-0500	718	104
76 0131 0011 00008-0200	713 - 763	130	76 0731 0011 00005-0200	713 - 763	131	77 0606 0000 50704-0200	763	125	77 3406 0000 20003-0200	718	104
76 0131 0111 00012-0200	713 - 763	130	76 0731 0011 00008-0200	713 - 763	131	77 0606 0000 50704-0500	763	125	77 3406 0000 20003-0500	718	104
76 0132 0011 00004-0200	713 - 763	136	76 0731 0111 00012-0200	713 - 763	131	77 0606 0605 50704-0200	765	147	77 3406 0000 20004-0200	718	104
76 0132 0011 00005-0200	713 - 763	136	76 0732 0011 00004-0200	713 - 763	137	77 0606 0605 50704-0500	765	147	77 3406 0000 20004-0500	718	104
76 0132 0011 00008-0200	713 - 763	136	76 0732 0011 00005-0200	713 - 763	137	77 0629 0000 50704-0200	813	187	77 3406 0000 20006-0200	718	104
76 0132 0111 00012-0200	713 - 763	136	76 0732 0011 00008-0200	713 - 763	137	77 0629 0000 50704-0500	813	187	77 3406 0000 20006-0500	718	104
76 0133 0011 00104-0200	715 - 766	162	76 0732 0111 00012-0200	713 - 763	137	77 0630 0000 50704-0200	813	188	77 3406 0000 20008-0200	718	104
76 0133 0011 00105-0200	715 - 766	162	76 0733 0011 00104-0200	715 - 766	162	77 0630 0000 50704-0500	813	188	77 3406 0000 20008-0500	718	104
76 0134 0011 00104-0200	715 - 766	164	76 0733 0011 00105-0200	715 - 766	162	77 0630 0629 50704-0200	765	148	77 3408 0000 20003-0200	718	104
76 0134 0011 00105-0200	715 - 766	164	76 0734 0011 00104-0200	715 - 766	164	77 0630 0629 50704-0500	765	148	77 3408 0000 20003-0500	718	104
76 0136 0011 00404-0200	825	173	76 0734 0011 00105-0200	715 - 766	164	77 0689 0000 50704-0200	814	180	77 3408 0000 20004-0200	718	104
76 0231 0011 00004-0200	713 - 763	130	76 0831 0011 00004-0200	713 - 763	131	77 0689 0000 50704-0500	814	180	77 3408 0000 20004-0500	718	104
76 0231 0011 00005-0200	713 - 763	130	76 0831 0011 00005-0200	713 - 763	131	77 0690 0000 50704-0200	814	180	77 3408 0000 20003-0200	718	104
76 0231 0011 00008-0200	713 - 763	130	76 0831 0011 00008-0200	713 - 763	131	77 0690 0000 50704-0500	814	180	77 3408 0000 20003-0500	718	104
76 0231 0011 00104-0200	713 - 763	130	76 0831 0111 00012-0200	713 - 763	131	77 0690 0689 50704-0200	765	148	77 3408 0000 20004-0200	718	104
76 0231 0011 00105-0200	713 - 763	130	76 0832 0011 00004-0200	713 - 763	137	77 0690 0689 50704-0500	765	148	77 3408 0000 20004-0500	718	104
76 0231 0011 00204-0200	713 - 763	130	76 0832 0011 00005-0200	713 - 763	137	77 1427 0000 50003-0200	870	194	77 3408 0000 20006-0200	718	104
76 0231 0011 00205-0200	713 - 763	130	76 0832 0011 00008-0200	713 - 763	137	77 1427 0000 50003-0500	870	194	77 3408 0000 20006-0500	718	104
76 0231 0011 00304-0200	713 - 763	130	76 0832 0111 00012-0200	713 - 763	137	77 1427 0000 50003-1000	870	194	77 3408 0000 20008-0200	718	104
76 0231 0011 00305-0200	713 - 763	130	76 0833 0011 00104-0200	715 - 766	162	77 1427 0000 50004-0200	870	194	77 3408 0000 20008-0500	718	104
76 0231 0011 00404-0200	713 - 763	130	76 0833 0011 00105-0200	715 - 766	162	77 1427 0000 50004-0500	870	194	77 3427 0000 20003-0200	763	118
76 0231 0011 00405-0200	713 - 763	130	76 0834 0011 00104-0200	715 - 766	164	77 1427 0000 50004-1000	870	194	77 3427 0000 20003-0500	763	118
76 0231 0011 00504-0200	713 - 763	130	76 0834 0011 00105-0200	715 - 766	164	77 1427 0000 50005-0200	870	194	77 3427 0000 20004-0200	763	118
76 0231 0011 00505-0200	713 - 763	130	76 0931 0111 00004-0200	713 - 763	132	77 1427 0000 50005-0500	870	194	77 3427 0000 20004-0500	763	118
76 0231 0011 00604-0200	713 - 763	130	76 0931 0111 00005-0200	713 - 763	132	77 1427 0000 50005-1000	870	194	77 3427 0000 20005-0200	763	118
76 0231 0011 00605-0200	713 - 763	130	76 0931 0111 00008-0200	713 - 763	132	77 1429 0000 50003-0200	870	194	77 3427 0000 20005-0500	763	118
76 0231 0011 00505-0200	713 - 763	130	76 0931 0111 00012-0200	713 - 763	132	77 1429 0000 50003-0500	870	194	77 3427 0000 20708-0200	763	118
76 0231 0111 00012-0200	713 - 763	130	76 0932 0111 00004-0200	713 - 763	137	77 1429 0000 50003-1000	870	194	77 3427 0000 20708-0500	763	118
76 0232 0011 00004-0200	713 -										



# Index

Part number	Series	Page	Part number	Series	Page	Part number	Series	Page	Part number	Series	Page
77 3730 3729 20912-0500	765	147	77 4434 0000 20004-0500	766	158	79 1455 212 05	702	22	79 5072 10 03	765	146
77 3734 0000 20403-0200	763	127	77 4434 0000 20005-0200	766	158	79 1455 215 05	702	22	79 5072 20 03	765	146
77 3734 0000 20403-0500	763	127	77 4434 0000 20005-0500	766	158	79 1455 272 05	702	22	79 5073 10 04	765	146
77 3734 0000 20404-0200	763	127	77 4434 0000 50003-0200	766	158	79 1455 275 05	702	22	79 5073 20 04	765	146
77 3734 0000 20404-0500	763	127	77 4434 0000 50003-0500	766	158	79 1456 212 05	702	23	79 5076 10 03	765	146
77 3734 0000 20405-0200	763	127	77 4434 0000 50004-0200	766	158	79 1456 215 05	702	23	79 5076 20 03	765	146
77 3734 0000 20405-0500	763	127	77 4434 0000 50004-0500	766	158	79 1456 272 05	702	23	79 5077 10 04	765	146
77 3734 0000 20908-0200	763	127	77 4434 0000 50005-0200	766	158	79 1456 275 05	702	23	79 5077 20 04	765	146
77 3734 0000 20908-0500	763	127	77 4434 0000 50005-0500	766	158	79 1461 212 08	702	22	79 5100 10 03	765	147
77 3734 0000 20912-0200	763	127	77 4529 0000 50704-0200	825	169	79 1461 215 08	702	22	79 5100 20 03	765	147
77 3734 0000 20912-0500	763	127	77 4529 0000 50704-0500	825	169	79 1461 272 08	702	22	79 5101 10 04	765	147
77 3734 0000 50003-0200	763	127	77 4529 0000 50704-1000	825	169	79 1461 275 08	702	22	79 5101 20 04	765	147
77 3734 0000 50003-0500	763	127	77 4530 0000 50704-0200	825	170	79 1462 212 08	702	23	79 5200 00 04	765	152
77 3734 0000 50004-0200	763	127	77 4530 0000 50704-0500	825	170	79 1462 215 08	702	23	79 5200 10 04	765	150
77 3734 0000 50004-0500	763	127	77 4530 0000 50704-1000	825	170	79 1462 272 08	702	23	79 5200 20 04	765	150
77 3734 0000 50005-0200	763	127	77 9827 3406 50003-0100	765	150	79 1462 275 08	702	23	79 5204 00 04	765	152
77 3734 0000 50005-0500	763	127	77 9827 3406 50003-0200	765	150	79 3101 32 03	707	94	79 5204 10 04	765	150
77 3734 0000 50708-0200	763	127	77 9827 3430 50003-0100	765	150	79 3101 35 03	707	94	79 5204 20 04	765	150
77 3734 0000 50708-0500	763	127	77 9827 3430 50003-0200	765	150	79 3101 52 03	707	94	79 5206 10 04	765	150
77 3734 3727 20403-0200	765	149	77 9835 0000 00004	766	157	79 3101 55 03	707	94	79 5206 20 04	765	150
77 3734 3727 20403-0500	765	149	77 9839 0000 00005	763	117	79 3102 32 03	707	94	79 5207 00 05	765	152
77 3734 3727 20404-0200	765	149	77 9840 0000 00005	763	125	79 3102 35 03	707	94	79 5208 00 05	765	152
77 3734 3727 20404-0500	765	149	79 0231 20 04	693	73	79 3102 52 03	707	94	79 5210 00 05	765	153
77 3734 3727 20405-0200	765	149	79 0232 20 04	693	75	79 3102 55 03	707	94	79 5210 17 05	765	153
77 3734 3727 20405-0500	765	149	79 0233 20 04	693	73	79 3103 32 03	707	94	79 5211 00 08	765	153
77 3734 3727 20908-0200	765	149	79 0234 20 04	693	75	79 3103 35 03	707	94	79 5212 00 05	765	153
77 3734 3727 20908-0500	765	149	79 0235 20 07	693	73	79 3103 52 03	707	94	79 5229 10 05	765	150
77 3734 3727 20912-0200	765	149	79 0236 20 07	693	75	79 3103 55 03	707	94	79 5229 20 05	765	150
77 3734 3727 20912-0500	765	149	79 0237 20 07	693	73	79 3104 32 03	707	94	79 5232 00 04	765	152
77 3734 3729 20403-0200	765	148	79 0238 20 07	693	75	79 3104 35 03	707	94	79 5232 33 04	765	151
77 3734 3729 20403-0500	765	148	79 1401 12 02	702	22	79 3104 52 03	707	94	79 5232 70 04	765	152
77 3734 3729 20404-0200	765	148	79 1401 15 02	702	22	79 3104 55 03	707	94	79 5232 90 04	765	152
77 3734 3729 20404-0500	765	148	79 1401 72 02	702	22	79 3107 32 04	707	94	79 5236 40 05	765	153
77 3734 3729 20405-0200	765	148	79 1401 75 02	702	22	79 3107 35 04	707	94	79 5236 90 04	765	153
77 3734 3729 20405-0500	765	148	79 1402 12 02	702	23	79 3107 52 04	707	94	79 5238 10 04	765	151
77 3734 3729 20908-0200	765	148	79 1402 15 02	702	23	79 3107 55 04	707	94	79 5238 20 04	765	151
77 3734 3729 20908-0500	765	148	79 1402 72 02	702	23	79 3108 32 04	707	94	79 5254 100 04	765	153
77 3734 3729 20912-0200	765	148	79 1402 75 02	702	23	79 3108 35 04	707	94	79 5255 100 05	765	153
77 3734 3729 20912-0500	765	148	79 1405 12 03	702	22	79 3108 52 04	707	94	79 5256 100 05	765	153
77 3834 0000 50003-0200	763	128	79 1405 15 03	702	22	79 3108 55 04	707	94	79 5280 00 04	765	152
77 3834 0000 50003-0500	763	128	79 1405 72 03	702	22	79 3109 32 04	707	94	79 5700 10 03	210	202
77 4329 0000 60702-0200	766	157	79 1405 75 03	702	22	79 3109 35 04	707	94	79 5700 20 03	210	202
77 4329 0000 60702-0500	766	157	79 1406 12 03	702	23	79 3109 52 04	707	94	79 5701 10 03	210	202
77 4329 0000 60702-1000	766	157	79 1406 15 03	702	23	79 3109 55 04	707	94	79 5701 20 03	210	202
77 4330 0000 60702-0200	766	158	79 1406 72 03	702	23	79 3110 32 04	707	94	79 5703 10 04	210	202
77 4330 0000 60702-0500	766	158	79 1406 75 03	702	23	79 3110 35 04	707	94	79 5703 20 04	210	202
77 4330 0000 60702-1000	766	158	79 1409 12 04	702	22	79 3110 52 04	707	94	79 5704 10 03	210	202
77 4427 0000 20003-0200	766	157	79 1409 15 04	702	22	79 3110 55 04	707	94	79 5704 20 03	210	202
77 4427 0000 20003-0500	766	157	79 1409 72 04	702	22	79 3121 52 03	707	94	79 5705 10 03	210	202
77 4427 0000 20004-0200	766	157	79 1409 75 04	702	22	79 3121 525 03	707	94	79 5705 20 03	210	202
77 4427 0000 20004-0500	766	157	79 1410 12 04	702	23	79 3122 52 03	707	94	79 5706 10 03	210	202
77 4427 0000 20005-0200	766	157	79 1410 15 04	702	23	79 3122 525 03	707	94	79 5706 20 03	210	202
77 4427 0000 20005-0500	766	157	79 1410 72 04	702	23	79 3127 52 04	707	94	79 5712 10 03	220	206
77 4427 0000 50003-0200	766	157	79 1410 75 04	702	23	79 3127 525 04	707	94	79 5712 20 03	220	206
77 4427 0000 50003-0500	766	157	79 1413 12 05	702	22	79 3128 52 04	707	94	79 5713 10 03	220	206
77 4427 0000 50004-0200	766	157	79 1413 15 05	702	22	79 3128 525 04	707	94	79 5713 20 03	220	206
77 4427 0000 50004-0500	766	157	79 1413 72 05	702	22	79 5000 10 04	765	147	79 5714 10 03	220	206
77 4427 0000 50005-0200	766	157	79 1413 75 05	702	22	79 5000 20 04	765	147	79 5714 20 03	220	206
77 4427 0000 50005-0500	766	157	79 1414 12 05	702	23	79 5001 10 04	765	147	79 5715 10 03	220	206
77 4429 0000 20003-0200	766	157	79 1414 15 05	702	23	79 5001 20 04	765	147	79 5715 20 03	220	206
77 4429 0000 20003-0500	766	157	79 1414 72 05	702	23	79 5002 10 05	765	147	79 5717 10 03	220	206
77 4429 0000 20004-0200	766	157	79 1414 75 05	702	23	79 5002 20 05	765	147	79 5717 20 03	220	206
77 4429 0000 20004-0500	766	157	79 1421 12 07	702	22	79 5003 10 04	765	148	79 5718 10 03	220	207
77 4429 0000 20005-0200	766	157	79 1421 15 07	702	22	79 5003 20 04	765	148	79 5718 20 03	220	207
77 4429 0000 20005-0500	766	157	79 1421 72 07	702	22	79 5004 10 04	765	148	79 5719 10 03	220	207
77 4429 0000 50003-0200	766	157	79 1421 75 07	702	22	79 5004 20 04	765	148	79 5719 20 03	220	207
77 4429 0000 50003-0500	766	157	79 1422 12 07	702	23	79 5008 10 03	765	147	79 5720 10 03	220	207
77 4429 0000 50004-0200	766	157	79 1422 15 07	702	23	79 5008 20 03	765	147	79 5720 20 03	220	207
77 4429 0000 50004-0500	766	157	79 1422 72 07	702	23	79 5009 10 04	765	147	79 5721 10 03	220	208
77 4429 0000 50005-0200	766	157	79 1422 75 07	702	23	79 5009 20 04	765	147	79 5721 20 03	220	208
77 4429 0000 50005-0500	766	157	79 1425 12 08	702	22	79 5011 10 03	765	147	79 5722 10 03	220	207
77 4430 0000 20003-0200	766	158	79 1425 15 08	702	22	79 5011 20 03	765	147	79 5722 20 03	220	207
77 4430 0000 20003-0500	766	158	79 1425 72 08	702	22	79 5027 10 04	765	148	79 6013 20 05	425	55
77 4430 0000 20004-0200	766	158	79 1425 75 08	702	22	79 5027 20 04	765	148	79 6014 20 05	425	55
77 4430 0000 20004-0500	766	158	79 1426 12 08	702	23	79 5028 10 04	765	148	79 6029 20 12	425	57
77 4430 0000 20005-0200	766	158	79 1426 15 08	702	23	79 5028 20 04	765	148	79 6030 20 12	425	57
77 4430 0000 20005-0500	766	158	79 1426 72 08	702	23	79 5029 10 05	765	148	79 6071 20 08	425	55
77 4430 0000 50003-0200	766	158	79 1426 75 08	702	23	79 5029 20 05	765	148	79 6072 20 08	425	57
77 4430 0000 50003-0500	766	158	79 1451 212 03	702	22	79 5032 10 03	765	146	79 6113 20 05	425	55
77 4430 0000 50004-0200	766	158	79 1451 215 03	702	22	79 5032 20 03	765	146	79 6114 20 05	425	57
77 4430 0000											

# Index

Part number	Series	Page	Part number	Series	Page	Part number	Series	Page	Part number	Series	Page
79 6213 200 05	425	55	86 0531 1002 00004	713 - 763	132	99 0072 102 02	711	18	99 0405 70 03	712	20
79 6214 200 05	425	55	86 0531 1002 00005	713 - 763	132	99 0075 100 03	711	18	99 0405 75 03	712	20
79 6229 200 12	425	55	86 0531 1002 00008	713 - 763	132	99 0075 102 03	711	18	99 0406 00 03	712	21
79 6230 200 12	425	57	86 0531 1100 00012	713 - 763	132	99 0076 100 03	711	18	99 0406 10 03	712	21
79 6271 200 08	425	55	86 0531 1120 00004	713 - 763	132	99 0076 102 03	711	18	99 0406 115 03	712	21
79 6272 200 08	425	57	86 0531 1120 00005	713 - 763	132	99 0079 100 04	711	18	99 0406 70 03	712	20
79 6313 200 05	425	55	86 0531 1120 00008	713 - 763	132	99 0079 102 04	711	18	99 0406 75 03	712	20
79 6314 200 05	425	57	86 0531 1120 00012	713 - 763	132	99 0080 100 04	711	18	99 0409 00 04	712	21
79 6317 200 06	425	55	86 0531 1121 00004	713 - 763	133	99 0080 102 04	711	18	99 0409 10 04	712	21
79 6318 200 06	425	57	86 0531 1121 00005	713 - 763	133	99 0095 100 05	711	18	99 0409 115 04	712	21
79 6329 200 12	425	55	86 0532 1000 00004	713 - 763	138	99 0095 102 05	711	18	99 0409 70 04	712	20
79 6330 200 12	425	57	86 0532 1000 00005	713 - 763	138	99 0096 100 05	711	18	99 0409 75 04	712	20
79 6371 200 08	425	55	86 0532 1000 00008	713 - 763	138	99 0096 102 05	711	18	99 0410 00 04	712	21
79 6372 200 08	425	57	86 0532 1002 00004	713 - 763	137	99 0105 106 03	723	58	99 0410 10 04	712	21
79 9001 12 03	709	7	86 0532 1002 00005	713 - 763	137	99 0105 75 03	723	58	99 0410 115 04	712	21
79 9001 15 03	709	7	86 0532 1002 00008	713 - 763	137	99 0106 106 03	723	58	99 0410 70 04	712	20
79 9002 12 03	709	7	86 0532 1100 00012	713 - 763	138	99 0106 75 03	723	58	99 0410 75 04	712	20
79 9002 15 03	709	7	86 0532 1120 00004	713 - 763	138	99 0109 106 04	723	58	99 0413 00 05	712	21
79 9003 12 04	709	7	86 0532 1120 00005	713 - 763	138	99 0109 75 04	723	58	99 0413 10 05	712	21
79 9003 15 04	709	7	86 0532 1120 00008	713 - 763	138	99 0110 106 04	723	58	99 0413 115 05	712	21
79 9004 12 04	709	7	86 0532 1120 00012	713 - 763	138	99 0110 75 04	723	58	99 0413 70 05	712	20
79 9004 15 04	709	7	86 0532 1121 00004	713 - 763	138	99 0113 106 05	723	58	99 0413 75 05	712	20
79 9005 15 05	709	7	86 0532 1121 00005	713 - 763	138	99 0113 75 05	723	58	99 0414 00 05	712	21
79 9006 12 05	709	7	86 0533 1000 00004	715 - 766	162	99 0114 106 05	723	58	99 0414 10 05	712	21
79 9006 15 05	709	7	86 0533 1000 00005	715 - 766	162	99 0114 75 05	723	58	99 0414 115 05	712	21
79 9149 020 03	720	29	86 0533 1120 00005	715 - 766	162	99 0121 106 06	723	58	99 0414 70 05	712	20
79 9150 020 03	720	29	86 0534 1000 00004	715 - 766	164	99 0121 75 06	723	58	99 0414 75 05	712	20
79 9157 020 05	720	29	86 0534 1000 00005	715 - 766	164	99 0122 106 06	723	58	99 0421 00 07	712	21
79 9158 020 05	720	29	86 0534 1120 00005	715 - 766	164	99 0122 75 06	723	58	99 0421 10 07	712	21
79 9169 020 08	720	29	86 0536 1000 00404	825	173	99 0125 106 07	723	58	99 0421 115 07	712	21
79 9170 020 08	720	29	86 0536 1120 00404	825	173	99 0125 75 07	723	58	99 0421 70 07	712	20
79 9177 020 12	720	29	86 0631 1000 00004	713 - 763	132	99 0126 106 07	723	58	99 0421 75 07	712	20
79 9178 020 12	720	29	86 0631 1000 00005	713 - 763	132	99 0126 75 07	723	58	99 0422 00 07	712	21
79 9237 020 03	620	9	86 0631 1000 00008	713 - 763	132	99 0129 106 12	723	58	99 0422 10 07	712	21
79 9238 020 03	620	9	86 0631 1002 00004	713 - 763	132	99 0129 75 12	723	58	99 0422 115 07	712	21
79 9241 020 04	620	9	86 0631 1002 00005	713 - 763	132	99 0130 106 12	723	58	99 0422 70 07	712	20
79 9242 020 04	620	9	86 0631 1002 00008	713 - 763	132	99 0130 75 12	723	58	99 0422 75 07	712	20
79 9245 020 05	620	9	86 0631 1100 00012	713 - 763	132	99 0135 10 03	682	46	99 0425 00 08	712	21
79 9246 020 05	620	9	86 0632 1000 00004	713 - 763	138	99 0135 12 03	682	46	99 0425 10 08	712	21
79 9257 020 08	620	9	86 0632 1000 00005	713 - 763	138	99 0136 10 03	682	47	99 0425 115 08	712	21
79 9258 020 08	620	9	86 0632 1000 00008	713 - 763	138	99 0136 12 03	682	47	99 0425 70 08	712	20
79 9722 020 08	825	176	86 0632 1002 00004	713 - 763	137	99 0137 10 04	682	46	99 0425 75 08	712	20
79 9722 050 08	825	176	86 0632 1002 00005	713 - 763	137	99 0137 12 04	682	46	99 0426 00 08	712	21
79 9722 100 08	825	176	86 0632 1002 00008	713 - 763	137	99 0138 10 04	682	47	99 0426 10 08	712	21
79 9723 020 08	825 - 876	177	86 0632 1100 00012	713 - 763	138	99 0138 12 04	682	47	99 0426 115 08	712	21
79 9723 050 08	825 - 876	177	86 1031 1100 00004	713 - 763	133	99 0139 10 05	682	46	99 0426 70 08	712	20
79 9723 100 08	825 - 876	177	86 1031 1100 00005	713 - 763	133	99 0139 12 05	682	46	99 0426 75 08	712	20
79 9724 020 08	825	176	86 1031 1100 00008	713 - 763	133	99 0140 10 05	682	47	99 0429 07 04	713	110
79 9724 050 08	825	176	86 1031 1100 00012	713 - 763	133	99 0140 12 05	682	47	99 0429 105 04	715	155
79 9724 100 08	825	176	86 1033 1100 00004	715 - 766	162	99 0143 10 06	682	46	99 0429 12 04	713	110
86 0131 0000 00004	713 - 763	132	86 1033 1100 00005	715 - 766	162	99 0143 12 06	682	46	99 0429 135 04	715	155
86 0131 0000 00005	713 - 763	132	86 2531 1100 00005	713 - 763	132	99 0144 10 06	682	47	99 0429 14 04	713	110
86 0131 0000 00008	713 - 763	132	86 2531 1100 00008	713 - 763	132	99 0144 12 06	682	47	99 0429 142 04	713	111
86 0131 0002 00004	713 - 763	131	86 2532 1100 00005	713 - 763	138	99 0145 10 07	682	46	99 0429 145 04	715	155
86 0131 0002 00005	713 - 763	131	86 2532 1100 00008	713 - 763	138	99 0145 12 07	682	46	99 0429 15 04	715	155
86 0131 0002 00008	713 - 763	131	86 4231 1002 00004	713 - 763	129	99 0146 10 07	682	47	99 0429 158 04	713	110
86 0131 0100 00012	713 - 763	132	86 4231 1002 00005	713 - 763	129	99 0146 12 07	682	47	99 0429 161 04	713	113
86 0132 0000 00004	713 - 763	138	86 4231 1002 00008	713 - 763	129	99 0147 10 12	682	46	99 0429 162 04	713	114
86 0132 0000 00005	713 - 763	138	86 4232 1002 00004	713 - 763	135	99 0147 12 12	682	46	99 0429 186 04	713	111
86 0132 0000 00008	713 - 763	138	86 4232 1002 00005	713 - 763	135	99 0148 10 12	682	47	99 0429 19 04	713	111
86 0132 0002 00004	713 - 763	136	86 4232 1002 00008	713 - 763	135	99 0148 12 12	682	47	99 0429 24 04	713	113
86 0132 0002 00005	713 - 763	136	86 4233 1002 00004	715 - 766	161	99 0153 10 08	682	46	99 0429 27 04	713	113
86 0132 0002 00008	713 - 763	136	86 4331 1002 00004	713 - 763	129	99 0153 12 08	682	46	99 0429 282 04	713	110
86 0132 0100 00012	713 - 763	138	86 4331 1002 00005	713 - 763	129	99 0154 10 08	682	47	99 0429 286 04	713	113
86 0133 0000 00005	715 - 766	162	86 4331 1002 00008	713 - 763	129	99 0154 12 08	682	47	99 0429 287 04	713	111
86 0134 0000 00005	715 - 766	164	86 4332 1002 00004	713 - 763	135	99 0163 10 19	682	46	99 0429 292 04	713	113
86 0136 0000 00404	825	173	86 4332 1002 00005	713 - 763	135	99 0163 12 19	682	46	99 0429 314 04	713	110
86 0231 0000 00004	713 - 763	132	86 4332 1002 00008	713 - 763	135	99 0164 10 19	682	47	99 0429 324 04	713	113
86 0231 0000 00005	713 - 763	132	86 4333 1002 00004	715 - 766	161	99 0164 12 19	682	47	99 0429 43 04	713	110
86 0231 0000 00008	713 - 763	132	86 4333 1002 00005	715 - 766	161	99 0171 106 08	723	58	99 0429 44 04	713	113
86 0231 0002 00004	713 - 763	131	86 4531 1002 00004	713 - 763	129	99 0171 75 08	723	58	99 0429 52 04	713	113
86 0231 0002 00005	713 - 763	131	86 4531 1002 00005	713 - 763	129	99 0172 106 08	723	58	99 0429 57 04	713	110
86 0231 0002 00008	713 - 763	131	86 4533 1002 00004	715 - 766	161	99 0172 75 08	723	58	99 0429 58 04	713	113
86 0231 0100 00012	713 - 763	132	86 4631 1002 00004	713 - 763	129	99 0401 00 02	712	21	99 0429 684 04	713	111
86 0232 0000 00004	713 - 763	138	86 4631 1002 00005	713 - 763	129	99 0401 10 02	712	21	99 0429 82 04	713	110
86 0232 0000 00005	713 - 763	138	86 4633 1002 00004	715 - 766	161	99 0401 115 02	712	21	99 0429 92 04	713	113
86 0232 0000 00008	713 - 763	138	86 4633 1002 00005	715 - 766	161	99 0401 70 02	712	20	99 0430 00 04	713	122
86 0232 0002 00004	713 - 763	136	86 4832 3000 00004	713 - 763	135	99 0401 75 02	712	20	99 0430 07 04	713	119
86 0232 0002 00005	713 - 763	136	86 4832 3000 00005	713 - 763	135	99 0402 00 02	712	21	99 0430 10 04	713	119
86 0232 0002 00008	713 - 763	136	86 4832 3000 00008	713 - 763							

# Index

Part number	Series	Page	Part number	Series	Page	Part number	Series	Page	Part number	Series	Page
99 0430 20 04	713	122	99 0491 52 12	713	113	99 0690 58 04	814	180	99 1430 995 04	715	159
99 0430 225 04	715	159	99 0492 12 12	713	119	99 0693 500 04	814	182	99 1431 814 04	713	112
99 0430 235 04	715	160	99 0492 52 12	713	122	99 0694 500 04	814	184	99 1431 824 04	713	114
99 0430 24 04	713	122	99 0524 12 04	713	119	99 0699 29 05	814	180	99 1432 814 04	713	121
99 0430 25 04	715	159	99 0524 14 04	713	119	99 0700 29 05	814	180	99 1432 824 04	713	123
99 0430 27 04	713	122	99 0524 24 04	713	122	99 0709 00 05	694	84	99 1433 810 04	715	154
99 0430 282 04	713	119	99 0524 52 04	713	122	99 0709 02 05	694	84	99 1433 814 04	713	112
99 0430 287 04	713	120	99 0525 12 04	713	110	99 0709 03 05	694	84	99 1433 820 04	715	155
99 0430 292 04	713	122	99 0525 14 04	713	110	99 0709 70 05	694	84	99 1433 824 04	713	114
99 0430 30 04	713	119	99 0525 24 04	713	113	99 0709 72 05	694	84	99 1434 810 04	715	159
99 0430 314 04	713	119	99 0525 52 04	713	113	99 0709 73 05	694	84	99 1434 814 04	713	121
99 0430 324 04	713	122	99 0527 12 04	713	111	99 0710 00 05	694	84	99 1434 820 04	715	160
99 0430 52 04	713	122	99 0527 14 04	713	111	99 0710 02 05	694	84	99 1434 824 04	713	123
99 0430 57 04	713	119	99 0528 12 04	713	120	99 0710 03 05	694	84	99 1436 810 05	715	159
99 0430 58 04	713	122	99 0528 14 04	713	120	99 0710 70 05	694	84	99 1436 812 05	713	121
99 0430 68 04	713	122	99 0529 12 04	713	110	99 0710 72 05	694	84	99 1436 814 05	713	121
99 0430 684 04	713	120	99 0529 14 04	713	110	99 0710 73 05	694	84	99 1436 820 05	715	160
99 0430 69 04	713	122	99 0529 24 04	713	113	99 0711 00 05	694	85	99 1436 822 05	713	122
99 0430 82 04	713	119	99 0529 52 04	713	113	99 0712 00 05	694	85	99 1436 824 05	713	122
99 0430 92 04	713	122	99 0530 12 04	713	119	99 0717 00 13	694	84	99 1436 910 05	715	159
99 0431 500 04	713 - 763	131	99 0530 14 04	713	119	99 0717 02 13	694	84	99 1436 920 05	715	160
99 0432 500 04	713 - 763	137	99 0530 24 04	713	122	99 0717 03 13	694	84	99 1436 935 05	715	159
99 0433 500 05	713 - 763	131	99 0530 52 04	713	122	99 0717 70 13	694	84	99 1436 991 05	713	121
99 0434 500 05	713 - 763	137	99 0536 12 05	713	119	99 0717 72 13	694	84	99 1436 992 05	713	121
99 0436 00 05	713	122	99 0536 14 05	713	119	99 0717 73 13	694	84	99 1436 995 05	715	159
99 0436 10 05	713	119	99 0536 24 05	713	122	99 0718 00 13	694	84	99 1437 810 05	715	154
99 0436 12 05	713	119	99 0536 52 05	713	122	99 0718 02 13	694	84	99 1437 812 05	713	112
99 0436 135 05	715	160	99 0537 12 05	713	110	99 0718 03 13	694	84	99 1437 814 05	713	112
99 0436 14 05	713	119	99 0537 14 05	713	110	99 0718 70 13	694	84	99 1437 820 05	715	155
99 0436 142 05	713	120	99 0537 24 05	713	113	99 0718 72 13	694	84	99 1437 822 05	713	114
99 0436 19 05	713	120	99 0537 52 05	713	113	99 0718 73 13	694	84	99 1437 824 05	713	114
99 0436 225 05	715	159	99 0605 00 03	678	34	99 0719 00 13	694	85	99 1437 910 05	715	154
99 0436 235 05	715	160	99 0605 70 03	678	34	99 0720 00 13	694	85	99 1437 920 05	715	155
99 0436 24 05	713	122	99 0606 00 03	678	34	99 0737 00 24	694	84	99 1437 935 05	715	154
99 0436 25 05	715	159	99 0606 70 03	678	34	99 0737 02 24	694	84	99 1437 991 05	713	112
99 0436 282 05	713	119	99 0607 00 03	678	35	99 0737 03 24	694	84	99 1437 992 05	713	112
99 0436 287 05	713	120	99 0608 00 03	678	35	99 0737 70 24	694	84	99 1437 995 05	715	154
99 0436 292 05	713	122	99 0609 00 04	678	34	99 0737 72 24	694	84	99 1438 810 05	715	159
99 0436 52 05	713	122	99 0609 70 04	678	34	99 0737 73 24	694	84	99 1438 814 05	713	121
99 0436 57 05	713	119	99 0610 00 04	678	34	99 0738 00 24	694	84	99 1438 820 05	715	160
99 0436 58 05	713	122	99 0610 70 04	678	34	99 0738 02 24	694	84	99 1438 824 05	713	123
99 0436 69 05	713	122	99 0611 00 04	678	35	99 0738 03 24	694	84	99 1438 910 05	715	159
99 0436 82 05	713	119	99 0612 00 04	678	35	99 0738 70 24	694	84	99 1439 810 05	715	154
99 0436 92 05	713	122	99 0613 00 05	678	34	99 0738 72 24	694	84	99 1439 814 05	713	112
99 0437 105 05	715	155	99 0613 70 05	678	34	99 0738 73 24	694	84	99 1439 820 05	715	155
99 0437 12 05	713	110	99 0614 00 05	678	34	99 0739 00 24	694	85	99 1439 824 05	713	114
99 0437 135 05	715	155	99 0614 70 05	678	34	99 0740 00 24	694	85	99 1439 910 05	715	154
99 0437 14 05	713	110	99 0615 00 05	678	35	99 0771 000 08	770	38	99 1486 812 08	713	121
99 0437 142 05	713	111	99 0616 00 05	678	35	99 0771 001 08	770	38	99 1486 914 08	713	121
99 0437 145 05	715	155	99 0617 00 06	678	34	99 0771 002 08	770	38	99 1486 992 08	713	121
99 0437 15 05	715	155	99 0617 70 06	678	34	99 0771 400 08	770	92	99 1487 812 08	713	112
99 0437 162 05	713	114	99 0618 00 06	678	34	99 0771 401 08	770	92	99 1487 914 08	713	112
99 0437 186 05	713	111	99 0618 70 06	678	34	99 0771 402 08	770	92	99 1487 992 08	713	112
99 0437 19 05	713	111	99 0619 00 06	678	35	99 0971 100 02	710	12	99 1488 812 08	713	121
99 0437 24 05	713	113	99 0620 00 06	678	35	99 0971 102 02	710	12	99 1488 814 08	713	121
99 0437 282 05	713	110	99 0621 00 07	678	34	99 0972 100 02	710	12	99 1489 812 08	713	112
99 0437 286 05	713	113	99 0621 70 07	678	34	99 0972 102 02	710	12	99 1489 814 08	713	112
99 0437 287 05	713	111	99 0622 00 07	678	34	99 0975 100 03	710	12	99 1491 812 12	713	112
99 0437 292 05	713	113	99 0622 70 07	678	34	99 0975 102 03	710	12	99 1491 822 12	713	114
99 0437 43 05	713	110	99 0623 00 07	678	35	99 0976 100 03	710	12	99 1492 812 12	713	121
99 0437 44 05	713	113	99 0624 00 07	678	35	99 0976 102 03	710	12	99 1492 822 12	713	122
99 0437 52 05	713	113	99 0629 19 04	813	186	99 0979 100 04	710	12	99 1525 812 04	713	112
99 0437 57 05	713	110	99 0629 58 04	813	186	99 0979 102 04	710	12	99 1525 814 04	713	112
99 0437 58 05	713	113	99 0630 19 04	813	188	99 0980 100 04	710	12	99 1525 822 04	713	114
99 0437 82 05	713	110	99 0630 58 04	813	188	99 0980 102 04	710	12	99 1525 824 04	713	114
99 0437 92 05	713	113	99 0633 500 04	813	189	99 0995 100 05	710	12	99 1526 812 04	713	121
99 0461 106 19	723	58	99 0634 500 04	813	191	99 0995 102 05	710	12	99 1526 814 04	713	121
99 0461 75 19	723	58	99 0639 29 05	813	186	99 0996 100 05	710	12	99 1526 822 04	713	122
99 0462 106 19	723	58	99 0640 29 05	813	188	99 0996 102 05	710	12	99 1526 824 04	713	122
99 0462 75 19	723	58	99 0645 00 08	678	34	99 1429 810 04	715	154	99 1527 814 04	713	112
99 0475 100 07	711	18	99 0645 70 08	678	34	99 1429 812 04	713	112	99 1527 824 04	713	114
99 0475 102 07	711	18	99 0646 00 08	678	34	99 1429 814 04	713	112	99 1528 814 04	713	121
99 0476 100 07	711	18	99 0646 70 08	678	34	99 1429 820 04	715	155	99 1528 824 04	713	123
99 0476 102 07	711	18	99 0647 00 08	678	35	99 1429 822 04	713	114	99 1533 810 05	715	154
99 0479 100 08	711	18	99 0648 00 08	678	35	99 1429 824 04	713	114	99 1533 820 05	715	155
99 0479 102 08	711	18	99 0649 00 12	678	34	99 1429 991 04	713	112	99 1533 910 05	715	154
99 0480 100 08	711	18	99 0649 70 12	678	34	99 1429 992 04	713	112	99 1534 810 05	715	159
99 0480 102 08	711	18	99 0650 00 12	678	34	99 1429 995 04	715	154	99 1534 820 05	715	160
99 0486 12 08	713	119	99 0650 70 12	678	34	99 1430 810 04	715	159	99 1534 910 05	715	159
99 0486 282 08	713	119	99 0651 00 12	678	35	99 1430 812 04	713	121	99 1535 810 05	715	154
99 0486 287 08	713	120	99 0652 00 12	678	35	99 1430 814 04	713	121	99 1535 820 05	715	155
99 0487 12 08	713	110	99 0685 19 03	814	180	99 1430 820 04	715	160	99 1535 910 05	715	154
99 0487 186 08	713	111	99 0686 19 03	814	180	99 1430 822 04	713	122	99 1535 920 05	715	155
99 0487 282 08	713	110	99 0689 19 04	814	180	99 1430 824 04	713	122	99 1536 810 05	715	159
99 0487 287 08	713	111	99 0689 58 04	814	180	99 1430 991 04	713	121	99 1536 820 05	715	160
99 0491 12 12	713	110	99 0690 19 04	814	180	99 1430 992 04	713	121	99 1536 910 05	715	159



# Index

Part number	Series	Page	Part number	Series	Page	Part number	Series	Page	Part number	Series	Page
99 1536 920 05	715	160	99 2026 700 07	581	45	99 2445 72 05	820	196	99 3481 200 08	713 - 763	133
99 1537 812 05	713	112	99 2026 702 07	581	45	99 2445 73 05	820	196	99 3481 202 08	713 - 763	133
99 1537 814 05	713	112	99 2029 00 12	581	44	99 3360 00 03	768	103	99 3481 351 08	713 - 763	133
99 1537 822 05	713	114	99 2029 02 12	581	44	99 3360 100 03	768	103	99 3481 401 08	713 - 763	133
99 1537 824 05	713	114	99 2029 10 12	581	44	99 3360 25 03	768	103	99 3481 458 08	713 - 763	133
99 1538 812 05	713	121	99 2029 20 12	581	44	99 3360 300 03	768	103	99 3481 601 08	713 - 763	133
99 1538 814 05	713	121	99 2030 00 12	581	45	99 3361 00 03	768	99	99 3482 200 08	713 - 763	139
99 1538 822 05	713	122	99 2030 02 12	581	45	99 3361 100 03	768	99	99 3482 202 08	713 - 763	139
99 1538 824 05	713	122	99 2030 10 12	581	45	99 3361 25 03	768	99	99 3482 351 08	713 - 763	139
99 1539 814 05	713	112	99 2030 20 12	581	45	99 3361 300 03	768	99	99 3482 352 08	713 - 763	139
99 1539 824 05	713	114	99 2041 00 19	581	44	99 3362 00 04	768	103	99 3482 401 08	713 - 763	139
99 1540 814 05	713	121	99 2041 02 19	581	44	99 3362 100 04	768	103	99 3482 402 08	713 - 763	139
99 1540 824 05	713	123	99 2041 10 19	581	44	99 3362 25 04	768	103	99 3482 458 08	713 - 763	139
99 1631 812 04	813	186	99 2041 20 19	581	44	99 3362 300 04	768	103	99 3482 601 08	713 - 763	139
99 1631 814 04	813	186	99 2042 00 19	581	45	99 3363 00 04	768	99	99 3721 810 04	825	168
99 1632 812 04	813	188	99 2042 02 19	581	45	99 3363 100 04	768	99	99 3721 820 04	825	169
99 1632 814 04	813	188	99 2042 10 19	581	45	99 3363 25 04	768	99	99 3727 810 04	825	168
99 1721 000 12	570	86	99 2042 20 19	581	45	99 3363 300 04	768	99	99 3727 820 04	825	169
99 1721 002 12	570	86	99 2061 00 08	581	44	99 3364 00 03	768	103	99 3728 810 04	825	170
99 1724 000 12	570	86	99 2061 02 08	581	44	99 3365 00 03	768	100	99 3728 820 04	825	170
99 2005 00 03	581	44	99 2061 10 08	581	44	99 3366 00 04	768	103	99 3729 810 04	825	168
99 2005 02 03	581	44	99 2061 20 08	581	44	99 3367 00 04	768	100	99 3729 820 04	825	169
99 2005 10 03	581	44	99 2061 700 08	581	44	99 3376 00 04	768	102	99 3729 995 04	825	168
99 2005 20 03	581	44	99 2061 702 08	581	44	99 3376 100 04	768	102	99 3730 810 04	825	170
99 2005 210 03	581	44	99 2062 00 08	581	45	99 3376 110 04	768	103	99 3730 820 04	825	170
99 2005 220 03	581	44	99 2062 02 08	581	45	99 3376 400 04	768	102	99 3731 200 04	825	172
99 2006 00 03	581	45	99 2062 10 08	581	45	99 3376 500 04	768	102	99 3731 201 04	825	172
99 2006 02 03	581	45	99 2062 20 08	581	45	99 3376 550 04	768	102	99 3731 202 04	825	172
99 2006 10 03	581	45	99 2062 700 08	581	45	99 3378 00 04	768	103	99 3731 203 04	825	172
99 2006 20 03	581	45	99 2062 702 08	581	45	99 3379 00 03	768	98	99 3731 401 04	825	172
99 2006 210 03	581	45	99 2440 12 03	820	195	99 3379 100 03	768	98	99 3732 200 04	825	173
99 2006 220 03	581	45	99 2440 21 03	820	195	99 3379 110 03	768	100	99 3732 201 04	825	173
99 2009 00 04	581	44	99 2440 282 03	820	195	99 3379 400 03	768	98	99 3732 202 04	825	173
99 2009 02 04	581	44	99 2440 32 03	820	195	99 3379 500 03	768	98	99 3732 203 04	825	173
99 2009 10 04	581	44	99 2440 42 03	820	195	99 3379 550 03	768	98	99 3732 401 04	825	174
99 2009 20 04	581	44	99 2440 52 03	820	196	99 3383 00 04	768	98	99 3732 402 04	825	174
99 2009 210 04	581	44	99 2440 62 03	820	196	99 3383 100 04	768	98	99 3782 200 08	825 - 876	177
99 2009 220 04	581	44	99 2440 72 03	820	196	99 3383 110 04	768	100	99 3782 202 08	825 - 876	177
99 2009 700 04	581	44	99 2441 12 03	820	195	99 3383 400 04	768	98	99 3782 210 08	825 - 876	177
99 2009 702 04	581	44	99 2441 21 03	820	195	99 3383 500 04	768	98	99 3782 213 08	825 - 876	177
99 2010 00 04	581	45	99 2441 282 03	820	195	99 3383 550 04	768	98	99 3787 810 08	825	176
99 2010 02 04	581	45	99 2441 32 03	820	195	99 3385 00 03	768	100	99 4201 00 07	693	72
99 2010 10 04	581	45	99 2441 42 03	820	195	99 3387 00 04	768	100	99 4201 110 07	693	72
99 2010 20 04	581	45	99 2441 52 03	820	196	99 3390 280 04	768 - 718	107	99 4201 14 07	693	72
99 2010 210 04	581	45	99 2441 62 03	820	196	99 3390 281 04	768 - 718	107	99 4201 160 07	693	72
99 2010 220 04	581	45	99 2441 72 03	820	196	99 3390 282 04	768 - 718	108	99 4201 210 07	693	73
99 2010 700 04	581	45	99 2442 12 04	820	195	99 3391 282 04	768 - 718	106	99 4201 215 07	693	73
99 2010 702 04	581	45	99 2442 21 04	820	195	99 3400 00 03	768	102	99 4201 300 07	693	73
99 2013 00 05	581	44	99 2442 282 04	820	195	99 3400 100 03	768	102	99 4201 70 07	693	73
99 2013 02 05	581	44	99 2442 32 04	820	195	99 3400 110 03	768	103	99 4202 00 07	693	74
99 2013 10 05	581	44	99 2442 42 04	820	195	99 3400 400 03	768	102	99 4202 110 07	693	74
99 2013 20 05	581	44	99 2442 52 04	820	196	99 3400 500 03	768	102	99 4202 14 07	693	74
99 2013 210 05	581	44	99 2442 62 04	820	196	99 3400 550 03	768	102	99 4202 160 07	693	74
99 2013 220 05	581	44	99 2442 72 04	820	196	99 3402 00 03	768	103	99 4202 210 07	693	75
99 2013 700 05	581	44	99 2443 12 04	820	195	99 3403 282 03	768 - 718	106	99 4202 215 07	693	75
99 2013 702 05	581	44	99 2443 21 04	820	195	99 3412 280 03	768 - 718	107	99 4202 300 07	693	75
99 2014 00 05	581	45	99 2443 282 04	820	195	99 3412 281 03	768 - 718	107	99 4202 70 07	693	75
99 2014 02 05	581	45	99 2443 32 04	820	195	99 3412 282 03	768 - 718	108	99 4217 00 07	693	72
99 2014 10 05	581	45	99 2443 42 04	820	195	99 3431 200 04	713 - 763	133	99 4217 110 07	693	72
99 2014 20 05	581	45	99 2443 52 04	820	196	99 3431 202 04	713 - 763	133	99 4217 14 07	693	72
99 2014 210 05	581	45	99 2443 62 04	820	196	99 3431 351 04	713 - 763	133	99 4217 160 07	693	72
99 2014 220 05	581	45	99 2443 72 04	820	196	99 3431 401 04	713 - 763	133	99 4217 210 07	693	73
99 2014 700 05	581	45	99 2444 12 05	820	195	99 3431 458 04	713 - 763	133	99 4217 215 07	693	73
99 2014 702 05	581	45	99 2444 21 05	820	195	99 3431 601 04	713 - 763	133	99 4217 300 07	693	73
99 2021 00 06	581	44	99 2444 23 05	820	195	99 3432 200 04	713 - 763	139	99 4217 70 07	693	73
99 2021 02 06	581	44	99 2444 282 05	820	195	99 3432 202 04	713 - 763	139	99 4218 00 07	693	74
99 2021 10 06	581	44	99 2444 32 05	820	195	99 3432 351 04	713 - 763	139	99 4218 110 07	693	74
99 2021 20 06	581	44	99 2444 33 05	820	195	99 3432 352 04	713 - 763	139	99 4218 14 07	693	74
99 2021 700 06	581	44	99 2444 42 05	820	195	99 3432 401 04	713 - 763	139	99 4218 160 07	693	74
99 2021 702 06	581	44	99 2444 43 05	820	195	99 3432 402 04	713 - 763	139	99 4218 210 07	693	75
99 2022 00 06	581	45	99 2444 52 05	820	196	99 3432 458 04	713 - 763	139	99 4218 215 07	693	75
99 2022 02 06	581	45	99 2444 62 05	820	196	99 3432 601 04	713 - 763	139	99 4218 300 07	693	75
99 2022 10 06	581	45	99 2444 63 05	820	196	99 3441 200 05	713 - 763	133	99 4218 70 07	693	75
99 2022 20 06	581	45	99 2444 72 05	820	196	99 3441 202 05	713 - 763	133	99 4221 00 04	693	72
99 2022 700 06	581	45	99 2444 73 05	820	196	99 3441 351 05	713 - 763	133	99 4221 110 04	693	72
99 2022 702 06	581	45	99 2445 12 05	820	195	99 3441 401 05	713 - 763	133	99 4221 14 04	693	72
99 2025 00 07	581	44	99 2445 21 05	820	195	99 3441 458 05	713 - 763	133	99 4221 160 04	693	72
99 2025 02 07	581	44	99 2445 23 05	820	195	99 3441 601 05	713 - 763	133	99 4221 210 04	693	73
99 2025 10 07	581	44	99 2445 282 05	820	195	99 3442 200 05	713 - 763	139	99 4221 215 04	693	73
99 2025 20 07	581	44	99 2445 32 05	820	195	99 3442 202 05	713 - 763	139	99 4221 300 04	693	73
99 2025 700 07	581	44	99 2445 33 05	820	195	99 3442 351 05	713 - 763	139	99 4221 70 04	693	73
99 2025 702 07	581	44	99 2445 42 05	820	195	99 3442 352 05	713 - 763	139	99 4222 00 04	693	74
99 2026 00 07	581	45	99 2445 43 05	820	195	99 3442 401 05	713 - 763	139	99 4222 110 04	693	74
99 2026 02 07	581	45	99 2445 52 05	820	196	99 3442 402 05	713 - 763	139	99 4222 14 04	693	74
99 2026 10 07	581	45	99 2445 62 05	820	196	9					

# Index

Part number	Series	Page	Part number	Series	Page	Part number	Series	Page	Part number	Series	Page
99 4222 215 04	693	75	99 4633 20 19	623	67	99 5113 15 05	423	54	99 5610 15 04	423	56
99 4222 300 04	693	75	99 4633 80 19	623	67	99 5113 210 05	423	54	99 5610 210 04	423	56
99 4222 70 04	693	75	99 4634 00 19	623	69	99 5113 40 05	423	55	99 5610 700 04	423	56
99 4225 00 07	693	72	99 4634 20 19	623	69	99 5113 700 05	423	54	99 5610 75 04	423	57
99 4225 110 07	693	72	99 4634 80 19	623	69	99 5113 740 05	423	55	99 5610 750 04	423	57
99 4225 14 07	693	72	99 4635 00 06	623	66	99 5113 75 05	423	55	99 5613 00 05	423	54
99 4225 160 07	693	72	99 4635 70 06	623	66	99 5113 750 05	423	55	99 5613 15 05	423	54
99 4225 210 07	693	73	99 4636 00 06	623	68	99 5114 00 05	423	56	99 5613 700 05	423	54
99 4225 215 07	693	73	99 4636 70 06	623	68	99 5114 15 05	423	56	99 5613 75 05	423	55
99 4225 300 07	693	73	99 4637 00 06	623	67	99 5114 210 05	423	56	99 5613 750 05	423	55
99 4225 70 07	693	73	99 4637 20 06	623	67	99 5114 40 05	423	56	99 5614 00 05	423	56
99 4226 00 07	693	74	99 4637 80 06	623	67	99 5114 700 05	423	56	99 5614 15 05	423	56
99 4226 110 07	693	74	99 4638 00 06	623	69	99 5114 740 05	423	56	99 5614 210 05	423	56
99 4226 14 07	693	74	99 4638 20 06	623	69	99 5114 75 05	423	57	99 5614 700 05	423	56
99 4226 160 07	693	74	99 4638 80 06	623	69	99 5114 750 05	423	57	99 5614 75 05	423	57
99 4226 210 07	693	75	99 4639 00 19	623	67	99 5121 00 06	423	54	99 5614 750 05	423	57
99 4226 215 07	693	75	99 4640 00 19	623	68	99 5121 15 06	423	54	99 5621 00 06	423	54
99 4226 300 07	693	75	99 4641 00 06	623	67	99 5121 40 06	423	55	99 5621 15 06	423	54
99 4226 70 07	693	75	99 4642 00 06	623	68	99 5121 700 06	423	54	99 5621 700 06	423	54
99 4431 401 04	715 - 766	163	99 4643 00 19	623	66	99 5121 740 06	423	55	99 5621 75 06	423	55
99 4432 401 04	715 - 766	165	99 4644 00 19	623	68	99 5121 75 06	423	55	99 5621 750 06	423	55
99 4432 402 04	715 - 766	165	99 4645 00 06	623	66	99 5121 750 06	423	55	99 5622 00 06	423	56
99 4441 401 05	715 - 766	163	99 4646 00 06	623	68	99 5122 00 06	423	56	99 5622 15 06	423	56
99 4442 200 05	715 - 766	164	99 4647 00 19	623	67	99 5122 15 06	423	56	99 5622 700 06	423	56
99 4442 202 05	715 - 766	165	99 4648 00 19	623	68	99 5122 40 06	423	56	99 5622 75 06	423	57
99 4442 401 05	715 - 766	165	99 4649 00 06	623	67	99 5122 700 06	423	56	99 5622 750 06	423	57
99 4442 402 05	715 - 766	165	99 4650 00 06	623	68	99 5122 740 06	423	56	99 5625 00 07	423	54
99 4442 458 05	715 - 766	164	99 4705 00 03	420	14	99 5122 75 06	423	57	99 5625 15 07	423	54
99 4442 601 05	715 - 766	165	99 4706 00 03	420	14	99 5122 750 06	423	57	99 5625 700 07	423	54
99 4445 200 05	715 - 766	163	99 4709 00 04	420	14	99 5125 00 07	423	54	99 5625 75 07	423	55
99 4445 202 05	715 - 766	163	99 4710 00 04	420	14	99 5125 15 07	423	54	99 5625 750 07	423	55
99 4445 458 05	715 - 766	163	99 4713 00 05	420	14	99 5125 40 07	423	55	99 5626 00 07	423	56
99 4445 601 05	715 - 766	163	99 4714 00 05	420	14	99 5125 700 07	423	54	99 5626 15 07	423	56
99 4601 00 09	623	66	99 4805 00 03	440	40	99 5125 740 07	423	55	99 5626 700 07	423	56
99 4601 70 09	623	66	99 4806 00 03	440	40	99 5125 75 07	423	55	99 5626 75 07	423	57
99 4602 00 09	623	68	99 4809 00 04	440	40	99 5125 750 07	423	55	99 5626 750 07	423	57
99 4602 70 09	623	68	99 4810 00 04	440	40	99 5126 00 07	423	56	99 5629 00 12	423	54
99 4603 00 09	623	67	99 4813 00 05	440	40	99 5126 15 07	423	56	99 5629 15 12	423	54
99 4603 20 09	623	67	99 4814 00 05	440	40	99 5126 40 07	423	56	99 5629 75 12	423	55
99 4603 80 09	623	67	99 4817 00 06	440	40	99 5126 700 07	423	56	99 5630 00 12	423	56
99 4604 00 09	623	69	99 4818 00 06	440	40	99 5126 740 07	423	56	99 5630 15 12	423	56
99 4604 20 09	623	69	99 4825 00 07	440	40	99 5126 75 07	423	57	99 5630 75 12	423	57
99 4604 80 09	623	69	99 4826 00 07	440	40	99 5126 750 07	423	57	99 5661 00 19	423	54
99 4605 00 12	623	66	99 4829 00 08	440	40	99 5129 00 12	423	54	99 5661 15 19	423	54
99 4605 70 12	623	66	99 4830 00 08	440	40	99 5129 15 12	423	54	99 5661 75 19	423	55
99 4606 00 12	623	68	99 4833 00 12	440	40	99 5129 40 12	423	55	99 5662 00 19	423	56
99 4606 70 12	623	68	99 4834 00 12	440	40	99 5129 75 12	423	55	99 5662 15 19	423	56
99 4607 00 12	623	67	99 4841 00 19	440	40	99 5130 00 12	423	56	99 5662 75 19	423	57
99 4607 20 12	623	67	99 4842 00 19	440	40	99 5130 15 12	423	56	99 5671 00 08	423	54
99 4607 80 12	623	67	99 4905 00 03	430	16	99 5130 40 12	423	56	99 5671 15 08	423	54
99 4608 00 12	623	69	99 4906 00 03	430	16	99 5130 75 12	423	57	99 5671 700 08	423	54
99 4608 20 12	623	69	99 4909 00 04	430	16	99 5171 00 08	423	54	99 5671 75 08	423	55
99 4608 80 12	623	69	99 4910 00 04	430	16	99 5171 15 08	423	54	99 5671 750 08	423	55
99 4609 00 16	623	66	99 4913 00 05	430	16	99 5171 40 08	423	55	99 5672 00 08	423	56
99 4609 70 16	623	66	99 4914 00 05	430	16	99 5171 700 08	423	54	99 5672 15 08	423	56
99 4610 00 16	623	68	99 4925 00 07	430	16	99 5171 740 08	423	55	99 5672 700 08	423	56
99 4610 70 16	623	68	99 4926 00 07	430	16	99 5171 75 08	423	55	99 5672 75 08	423	57
99 4611 00 16	623	67	99 4929 00 08	430	16	99 5171 750 08	423	55	99 5672 750 08	423	57
99 4611 20 16	623	67	99 4930 00 08	430	16	99 5172 00 08	423	56	99 5700 00 03	210	201
99 4611 80 16	623	67	99 5105 00 03	423	54	99 5172 15 08	423	56	99 5702 00 04	210	201
99 4612 00 16	623	69	99 5105 15 03	423	54	99 5172 40 08	423	56	99 6489 000 05	696	80
99 4612 20 16	623	69	99 5105 210 03	423	54	99 5172 700 08	423	56	99 6490 000 05	696	80
99 4612 80 16	623	69	99 5105 40 03	423	55	99 5172 740 08	423	56	99 6491 000 05	696	80
99 4613 00 09	623	67	99 5105 75 03	423	55	99 5172 75 08	423	57	99 6492 000 05	696	80
99 4614 00 09	623	68	99 5106 00 03	423	56	99 5172 750 08	423	57	99 6492 200 05	696	81
99 4615 00 12	623	67	99 5106 15 03	423	56	99 5461 00 19	423	54	99 6501 000 08	696	80
99 4616 00 12	623	68	99 5106 210 03	423	56	99 5461 15 19	423	54	99 6502 000 08	696	80
99 4617 00 16	623	67	99 5106 40 03	423	56	99 5461 40 19	423	55	99 6504 200 08	696	81
99 4618 00 16	623	68	99 5106 75 03	423	57	99 5461 75 19	423	55	99 6517 000 12	696	80
99 4619 00 09	623	66	99 5109 00 04	423	54	99 5462 00 19	423	56	99 6518 000 12	696	80
99 4620 00 09	623	68	99 5109 15 04	423	54	99 5462 15 19	423	56	99 6520 200 12	696	81
99 4621 00 12	623	66	99 5109 210 04	423	54	99 5462 40 19	423	56	99 9105 00 03	720	28
99 4622 00 12	623	68	99 5109 40 04	423	55	99 5462 75 19	423	57	99 9105 02 03	720	28
99 4623 00 16	623	66	99 5109 700 04	423	54	99 5605 00 03	423	54	99 9105 03 03	720	28
99 4624 00 16	623	68	99 5109 740 04	423	55	99 5605 15 03	423	54	99 9105 400 03	720	90
99 4625 00 09	623	67	99 5109 75 04	423	55	99 5605 75 03	423	55	99 9105 450 03	720	90
99 4626 00 09	623	68	99 5109 750 04	423	55	99 5606 00 03	423	56	99 9105 460 03	720	90
99 4627 00 12	623	67	99 5110 00 04	423	56	99 5606 15 03	423	56	99 9105 470 03	720	90
99 4628 00 12	623	68	99 5110 15 04	423	56	99 5606 210 03	423	56	99 9105 50 03	720	28
99 4629 00 16	623	67	99 5110 210 04	423	56	99 5606 75 03	423	57	99 9105 60 03	720	28
99 4630 00 16	623	68	99 5110 40 04	423	56	99 5609 00 04	423	54	99 9105 70 03	720	28
99 4631 00 19	623	66	99 5110 700 04	423	56	99 5609 15 04	423	54	99 9106 00 03	720	28
99 4631 70 19	623	66	99 5110 740 04	423	56	99 5609 700 04	423	54	99 9106 02 03	720	28
99 4632 00 19	623	68	99 5110 75 04	423	57	99 5609 75 04	423	55	99 9106 03 03	720	28
99 4632 70 19	623	68	99 5110 750 04	423	57	99 5609 750 04	423	55	99 9106 400 03	720	90
99 4633 00 19	623	67	99 5113 00 05	423	54	99 5610 00 04	423	56	99 9106 450 03	720	90

# Index

Part number	Series	Page	Part number	Series	Page	Part number	Series	Page	Part number	Series	Page
99 9106 460 03	720	90	99 9127 090 08	720	29	99 9208 050 03	620	10	99 9225 450 08	620	88
99 9106 470 03	720	90	99 9127 400 08	720	91	99 9208 050 03	620	89	99 9225 460 08	620	88
99 9106 50 03	720	28	99 9127 490 08	720	91	99 9208 060 03	620	10	99 9225 470 08	620	88
99 9106 60 03	720	28	99 9127 50 08	720	29	99 9208 060 03	620	89	99 9226 00 08	620	8
99 9106 70 03	720	28	99 9127 50 08	720	91	99 9208 070 03	620	10	99 9226 050 08	620	8
99 9107 00 03	720	29	99 9127 60 08	720	29	99 9208 070 03	620	89	99 9226 060 08	620	8
99 9107 090 03	720	29	99 9127 60 08	720	91	99 9208 090 03	620	10	99 9226 070 08	620	8
99 9107 400 03	720	91	99 9127 70 08	720	29	99 9208 400 03	620	89	99 9226 400 08	620	88
99 9107 490 03	720	91	99 9127 70 08	720	91	99 9208 490 03	620	89	99 9226 450 08	620	88
99 9107 50 03	720	29	99 9128 00 08	720	29	99 9209 00 04	620	8	99 9226 460 08	620	88
99 9107 50 03	720	91	99 9128 090 08	720	30	99 9209 050 04	620	8	99 9226 470 08	620	88
99 9107 60 03	720	29	99 9128 400 08	720	91	99 9209 060 04	620	8	99 9227 00 08	620	9
99 9107 60 03	720	91	99 9128 490 08	720	91	99 9209 070 04	620	8	99 9227 050 08	620	9
99 9107 70 03	720	29	99 9128 50 08	720	30	99 9209 400 04	620	88	99 9227 050 08	620	89
99 9107 70 03	720	91	99 9128 50 08	720	91	99 9209 450 04	620	88	99 9227 060 08	620	9
99 9108 00 03	720	29	99 9128 60 08	720	30	99 9209 460 04	620	88	99 9227 060 08	620	89
99 9108 090 03	720	30	99 9128 60 08	720	91	99 9209 470 04	620	88	99 9227 070 08	620	9
99 9108 400 03	720	91	99 9128 70 08	720	30	99 9210 00 04	620	8	99 9227 070 08	620	89
99 9108 490 03	720	91	99 9128 70 08	720	91	99 9210 050 04	620	8	99 9227 090 08	620	9
99 9108 50 03	720	30	99 9133 00 12	720	28	99 9210 060 04	620	8	99 9227 400 08	620	89
99 9108 50 03	720	91	99 9133 02 12	720	28	99 9210 070 04	620	8	99 9227 490 08	620	89
99 9108 60 03	720	30	99 9133 03 12	720	28	99 9210 400 04	620	88	99 9228 00 08	620	9
99 9108 60 03	720	91	99 9133 402 12	720	90	99 9210 450 04	620	88	99 9228 050 08	620	10
99 9108 70 03	720	30	99 9133 452 12	720	90	99 9210 460 04	620	88	99 9228 050 08	620	89
99 9108 70 03	720	91	99 9133 462 12	720	90	99 9210 470 04	620	88	99 9228 060 08	620	10
99 9113 00 05	720	28	99 9133 472 12	720	90	99 9211 00 04	620	9	99 9228 060 08	620	89
99 9113 02 05	720	28	99 9133 52 12	720	28	99 9211 050 04	620	9	99 9228 070 08	620	10
99 9113 03 05	720	28	99 9133 62 12	720	28	99 9211 050 04	620	89	99 9228 070 08	620	89
99 9113 400 05	720	90	99 9133 72 12	720	28	99 9211 060 04	620	9	99 9228 090 08	620	10
99 9113 450 05	720	90	99 9134 00 12	720	28	99 9211 060 04	620	89	99 9228 400 08	620	89
99 9113 460 05	720	90	99 9134 02 12	720	28	99 9211 070 04	620	9	99 9228 490 08	620	89
99 9113 470 05	720	90	99 9134 03 12	720	28	99 9211 070 04	620	89	99 9475 100 07	710	12
99 9113 50 05	720	28	99 9134 402 12	720	90	99 9211 090 04	620	9	99 9475 102 07	710	12
99 9113 60 05	720	28	99 9134 452 12	720	90	99 9211 400 04	620	89	99 9476 100 07	710	12
99 9113 70 05	720	28	99 9134 462 12	720	90	99 9211 490 04	620	89	99 9476 102 07	710	12
99 9114 00 05	720	28	99 9134 472 12	720	90	99 9212 00 04	620	9	99 9479 100 08	710	12
99 9114 02 05	720	28	99 9134 52 12	720	28	99 9212 050 04	620	10	99 9479 102 08	710	12
99 9114 03 05	720	28	99 9134 62 12	720	28	99 9212 050 04	620	89	99 9480 100 08	710	12
99 9114 400 05	720	90	99 9134 72 12	720	28	99 9212 060 04	620	10	99 9480 102 08	710	12
99 9114 450 05	720	90	99 9135 00 12	720	29	99 9212 060 04	620	89	99 9647 810 04	825	176
99 9114 460 05	720	90	99 9135 090 12	720	29	99 9212 070 04	620	10	99 9687 805 08	825	176
99 9114 470 05	720	90	99 9135 400 12	720	91	99 9212 070 04	620	89	99 9687 809 08	825	176
99 9114 50 05	720	28	99 9135 490 12	720	91	99 9212 090 04	620	10	99 9687 810 08	825	176
99 9114 60 05	720	28	99 9135 50 12	720	29	99 9212 400 04	620	89	99 9687 814 08	825	176
99 9114 70 05	720	28	99 9135 50 12	720	91	99 9212 490 04	620	89			
99 9115 00 05	720	29	99 9135 60 12	720	29	99 9213 00 05	620	8			
99 9115 090 05	720	29	99 9135 60 12	720	91	99 9213 050 05	620	8			
99 9115 400 05	720	91	99 9135 70 12	720	29	99 9213 060 05	620	8			
99 9115 490 05	720	91	99 9135 70 12	720	91	99 9213 070 05	620	8			
99 9115 50 05	720	29	99 9136 00 12	720	29	99 9213 400 05	620	88			
99 9115 50 05	720	91	99 9136 090 12	720	30	99 9213 450 05	620	88			
99 9115 60 05	720	29	99 9136 400 12	720	91	99 9213 460 05	620	88			
99 9115 60 05	720	91	99 9136 490 12	720	91	99 9213 470 05	620	88			
99 9115 70 05	720	29	99 9136 50 12	720	30	99 9214 00 05	620	8			
99 9115 70 05	720	91	99 9136 50 12	720	91	99 9214 050 05	620	8			
99 9116 00 05	720	29	99 9136 60 12	720	30	99 9214 060 05	620	8			
99 9116 090 05	720	30	99 9136 60 12	720	91	99 9214 070 05	620	8			
99 9116 400 05	720	91	99 9136 70 12	720	30	99 9214 400 05	620	88			
99 9116 490 05	720	91	99 9136 70 12	720	91	99 9214 450 05	620	88			
99 9116 50 05	720	30	99 9205 00 03	620	8	99 9214 460 05	620	88			
99 9116 50 05	720	91	99 9205 050 03	620	8	99 9214 470 05	620	88			
99 9116 60 05	720	30	99 9205 060 03	620	8	99 9215 00 05	620	9			
99 9116 60 05	720	91	99 9205 070 03	620	8	99 9215 050 05	620	9			
99 9116 70 05	720	30	99 9205 400 03	620	88	99 9215 050 05	620	89			
99 9116 70 05	720	91	99 9205 450 03	620	88	99 9215 060 05	620	9			
99 9125 00 08	720	28	99 9205 460 03	620	88	99 9215 060 05	620	89			
99 9125 02 08	720	28	99 9205 470 03	620	88	99 9215 070 05	620	9			
99 9125 03 08	720	28	99 9206 00 03	620	8	99 9215 070 05	620	89			
99 9125 400 08	720	90	99 9206 050 03	620	8	99 9215 090 05	620	9			
99 9125 450 08	720	90	99 9206 060 03	620	8	99 9215 400 05	620	89			
99 9125 460 08	720	90	99 9206 070 03	620	8	99 9215 490 05	620	89			
99 9125 470 08	720	90	99 9206 400 03	620	88	99 9216 00 05	620	9			
99 9125 50 08	720	28	99 9206 450 03	620	88	99 9216 050 05	620	10			
99 9125 60 08	720	28	99 9206 460 03	620	88	99 9216 050 05	620	89			
99 9125 70 08	720	28	99 9206 470 03	620	88	99 9216 060 05	620	10			
99 9126 00 08	720	28	99 9207 00 03	620	9	99 9216 060 05	620	89			
99 9126 02 08	720	28	99 9207 050 03	620	9	99 9216 070 05	620	10			
99 9126 03 08	720	28	99 9207 050 03	620	89	99 9216 070 05	620	89			
99 9126 400 08	720	90	99 9207 060 03	620	9	99 9216 090 05	620	10			
99 9126 450 08	720	90	99 9207 060 03	620	89	99 9216 400 05	620	89			
99 9126 460 08	720	90	99 9207 070 03	620	9	99 9216 490 05	620	89			
99 9126 470 08	720	90	99 9207 070 03	620	89	99 9225 00 08	620	8			
99 9126 50 08	720	28	99 9207 090 03	620	9	99 9225 050 08	620	8			
99 9126 60 08	720	28	99 9207 400 03	620	89	99 9225 060 08	620	8			
99 9126 70 08	720	28	99 9207 490 03	620	89	99 9225 070 08	620	8			
99 9127 00 08	720	29	99 9208 00 03	620	9	99 9225 400 08	620	88			

## Compare list of change numbers of moulded M8/M12 cable connectors and M12 panel mount connectors with single wires

Number old	Number new	Series	Page	Number old	Number new	Series	Page	Number old	Number new	Series	Page
09 3431 00 04	76 0131 0011 00004-0200	713-763	125	09 3481 116 08	76 0531 1011 00008-0200	713-763	126	79 3405 45 03	77 3405 0000 20003-0500	718	96
09 3431 116 04	76 0531 1011 00004-0200	713-763	126	09 3481 120 08	76 0631 1011 00008-0200	713-763	126	79 3405 52 03	77 3405 0000 50003-0200	718	96
09 3431 120 04	76 0631 1011 00004-0200	713-763	126	09 3481 22 08	76 0731 0011 00008-0200	713-763	126	79 3405 55 03	77 3405 0000 50003-0500	718	96
09 3431 22 04	76 0731 0011 00004-0200	713-763	126	09 3481 282 08	76 2131 0111 00008-0200	713-763	125	79 3406 42 03	77 3406 0000 20003-0200	718	99
09 3431 282 04	76 2131 0111 00004-0200	713-763	125	09 3481 50 08	76 0331 0111 00008-0200	713-763	126	79 3406 45 03	77 3406 0000 20003-0500	718	99
09 3431 50 04	76 0331 0111 00004-0200	713-763	126	09 3481 550 08	86 1031 1100 00008	713-763	128	79 3406 52 03	77 3406 0000 50003-0200	718	99
09 3431 550 04	86 1031 1100 00004	713-763	128	09 3481 600 08	86 0531 1120 00008	713-763	127	79 3406 55 03	77 3406 0000 50003-0500	718	99
09 3431 600 04	86 0531 1120 00004	713-763	127	09 3481 678 08	76 2731 0111 00008-0200	713-763	126	79 3407 42 03	77 3403 0000 20003-0200	718	96
09 3431 605 04	86 0531 1121 00004	713-763	128	09 3481 700 08	76 0231 0011 00008-0200	713-763	125	79 3407 45 03	77 3403 0000 20003-0500	718	96
09 3431 678 04	76 2731 0111 00004-0200	713-763	126	09 3481 722 08	76 0831 0011 00008-0200	713-763	126	79 3407 52 03	77 3403 0000 50003-0200	718	96
09 3431 700 04	76 0231 0011 00004-0200	713-763	125	09 3481 88 08	86 0131 0000 00008	713-763	126	79 3407 55 03	77 3403 0000 50003-0500	718	96
09 3431 722 04	76 0831 0011 00004-0200	713-763	126	09 3481 90 08	86 0531 1000 00008	713-763	127	79 3408 42 03	77 3408 0000 20003-0200	718	99
09 3431 77 04	86 0131 0002 00004	713-763	126	09 3482 116 08	76 0532 1011 00008-0200	713-763	132	79 3408 45 03	77 3408 0000 20003-0500	718	99
09 3431 778 04	76 2831 0111 00004-0200	713-763	126	09 3482 120 08	76 0632 1011 00008-0200	713-763	132	79 3408 52 03	77 3408 0000 50003-0200	718	99
09 3431 828 04	76 2231 0111 00004-0200	713-763	125	09 3482 22 08	76 0732 0011 00008-0200	713-763	132	79 3408 55 03	77 3408 0000 50003-0500	718	99
09 3431 88 04	86 0131 0000 00004	713-763	127	09 3482 275 08	86 0532 1000 00008	713-763	133	79 3427 12 04	77 3427 0000 20003-0200	763	113
09 3431 90 04	86 0531 1000 00004	713-763	127	09 3482 282 08	76 2132 0111 00008-0200	713-763	131	79 3427 13 04	77 3427 0000 20004-0200	763	113
09 3432 116 04	76 0532 1011 00004-0200	713-763	132	09 3482 600 08	86 0532 1120 00008	713-763	133	79 3427 15 04	77 3427 0000 20003-0500	763	113
09 3432 120 04	76 0632 1011 00004-0200	713-763	132	09 3482 678 08	76 2732 0111 00008-0200	713-763	132	79 3427 17 04	77 3427 0000 20004-0500	763	113
09 3432 22 04	76 0732 0011 00004-0200	713-763	132	09 3482 679 08	76 2532 1111 00008-0200	713-763	132	79 3427 32 04	77 3427 0000 50003-0200	763	113
09 3432 282 04	76 2132 0111 00004-0200	713-763	131	09 3482 700 08	76 0232 0011 00008-0200	713-763	131	79 3427 33 04	77 3427 0000 50004-0200	763	113
09 3432 600 04	86 0532 1120 00004	713-763	133	09 3482 722 08	76 0832 0011 00008-0200	713-763	132	79 3427 35 04	77 3427 0000 50003-0500	763	113
09 3432 605 04	86 0532 1121 00004	713-763	133	09 3483 00 08	76 0931 0111 00008-0200	713-763	127	79 3427 37 04	77 3427 0000 50004-0500	763	113
09 3432 678 04	76 2732 0111 00004-0200	713-763	132	09 3488 00 08	76 0932 0111 00008-0200	713-763	132	79 3427 52 04	77 3727 0000 50004-0200	763	113
09 3432 700 04	76 0232 0011 00004-0200	713-763	131	09 3491 00 12	76 0131 0111 00012-0200	713-763	125	79 3427 55 04	77 3727 0000 50004-0500	763	113
09 3432 722 04	76 0832 0011 00004-0200	713-763	132	09 3491 116 12	76 0531 1111 00012-0200	713-763	126	79 3429 12 04	77 3429 0000 20003-0200	763	111
09 3432 77 04	86 0132 0002 00004	713-763	131	09 3491 120 12	76 0631 1111 00012-0200	713-763	126	79 3429 13 04	77 3429 0000 20004-0200	763	111
09 3432 778 04	76 2832 0111 00004-0200	713-763	132	09 3491 22 12	76 0731 0111 00012-0200	713-763	126	79 3429 15 04	77 3429 0000 20003-0500	763	111
09 3432 828 04	76 2232 0111 00004-0200	713-763	131	09 3491 550 12	86 1031 1100 00012	713-763	128	79 3429 17 04	77 3429 0000 20004-0500	763	111
09 3432 88 04	86 0132 0000 00004	713-763	133	09 3491 600 12	86 0531 1120 00012	713-763	127	79 3429 32 04	77 3429 0000 50003-0200	763	111
09 3432 90 04	86 0532 1000 00004	713-763	133	09 3491 700 12	76 0231 0111 00012-0200	713-763	125	79 3429 33 04	77 3429 0000 50004-0200	763	111
09 3433 00 04	76 0931 0111 00004-0200	713-763	127	09 3491 722 12	76 0831 0111 00012-0200	713-763	126	79 3429 35 04	77 3429 0000 50003-0500	763	111
09 3441 00 05	76 0131 0011 00005-0200	713-763	125	09 3491 90 12	86 0531 1100 00012	713-763	127	79 3429 37 04	77 3429 0000 50004-0500	763	111
09 3441 116 05	76 0531 1011 00005-0200	713-763	126	09 3492 00 12	76 0132 0111 00012-0200	713-763	131	79 3429 52 04	77 3729 0000 50004-0200	763	111
09 3441 120 05	76 0631 1011 00005-0200	713-763	126	09 3492 116 12	76 0532 1111 00012-0200	713-763	132	79 3429 55 04	77 3729 0000 50004-0500	763	111
09 3441 22 05	76 0731 0011 00005-0200	713-763	126	09 3492 120 12	76 0632 1111 00012-0200	713-763	132	79 3430 12 04	77 3430 0000 20003-0200	763	119
09 3441 282 05	76 2131 0111 00005-0200	713-763	125	09 3492 22 12	76 0732 0111 00012-0200	713-763	132	79 3430 13 04	77 3430 0000 20004-0200	763	119
09 3441 50 05	76 0331 0111 00005-0200	713-763	126	09 3492 600 12	86 0532 1120 00012	713-763	133	79 3430 15 04	77 3430 0000 20003-0500	763	119
09 3441 550 05	86 1031 1100 00005	713-763	128	09 3492 700 12	76 0232 0111 00012-0200	713-763	131	79 3430 17 04	77 3430 0000 20004-0500	763	119
09 3441 600 05	86 0531 1120 00005	713-763	127	09 3492 722 12	76 0832 0111 00012-0200	713-763	132	79 3430 32 04	77 3430 0000 50003-0200	763	119
09 3441 605 05	86 0531 1121 00005	713-763	128	09 3492 90 12	86 0532 1100 00012	713-763	133	79 3430 33 04	77 3430 0000 50004-0200	763	119
09 3441 642 05	76 0431 0111 00005-0200	713-763	126	09 3493 00 12	76 0931 0111 00012-0200	713-763	127	79 3430 35 04	77 3430 0000 50003-0500	763	119
09 3441 678 05	76 2731 0111 00005-0200	713-763	126	09 3498 00 12	76 0932 0111 00012-0200	713-763	132	79 3430 37 04	77 3430 0000 50004-0500	763	119
09 3441 700 05	76 0231 0011 00005-0200	713-763	125	79 3381 42 04	77 3405 0000 20004-0200	718	96	79 3430 52 04	77 3730 0000 50003-0200	763	119
09 3441 722 05	76 0831 0011 00005-0200	713-763	126	79 3381 45 04	77 3405 0000 20004-0500	718	96	79 3430 55 04	77 3730 0000 50003-0500	763	119
09 3441 77 05	86 0131 0002 00005	713-763	126	79 3381 52 04	77 3405 0000 50004-0200	718	96	79 3430 562 04	77 3430 0000 70003-0200	763	119
09 3441 828 05	76 2231 0111 00005-0200	713-763	125	79 3381 55 04	77 3405 0000 50004-0500	718	96	79 3434 12 04	77 3434 0000 20003-0200	763	122
09 3441 88 05	86 0131 0000 00005	713-763	127	79 3382 42 04	77 3406 0000 20004-0200	718	99	79 3434 13 04	77 3434 0000 20004-0200	763	122
09 3441 90 05	86 0531 1000 00005	713-763	127	79 3382 45 04	77 3406 0000 20004-0500	718	99	79 3434 15 04	77 3434 0000 20003-0500	763	122
09 3442 116 05	76 0532 1011 00005-0200	713-763	132	79 3382 52 04	77 3406 0000 50004-0200	718	99	79 3434 17 04	77 3434 0000 20004-0500	763	122
09 3442 120 05	76 0632 1011 00005-0200	713-763	132	79 3382 55 04	77 3406 0000 50004-0500	718	99	79 3434 32 04	77 3434 0000 50003-0200	763	122
09 3442 22 05	76 0732 0011 00005-0200	713-763	132	79 3383 42 04	77 3403 0000 20004-0200	718	96	79 3434 33 04	77 3434 0000 50004-0200	763	122
09 3442 282 05	76 2132 0111 00005-0200	713-763	131	79 3383 45 04	77 3403 0000 20004-0500	718	96	79 3434 35 04	77 3434 0000 50003-0500	763	122
09 3442 600 05	86 0532 1120 00005	713-763	133	79 3383 52 04	77 3403 0000 50004-0200	718	96	79 3434 37 04	77 3434 0000 50004-0500	763	122
09 3442 605 05	86 0532 1121 00005	713-763	133	79 3383 55 04	77 3403 0000 50004-0500	718	96	79 3434 52 04	77 3734 0000 50003-0200	763	122
09 3442 700 05	76 0232 0011 00005-0200	713-763	131	79 3384 42 04	77 3408 0000 20004-0200	718	99	79 3434 55 04	77 3734 0000 50003-0500	763	122
09 3442 722 05	76 0832 0011 00005-0200	713-763	132	79 3384 45 04	77 3408 0000 20004-0500	718	99	79 3436 12 04	77 3634 0000 20003-0200	763	123
09 3442 77 05	86 0132 0002 00005	713-763	131	79 3384 52 04	77 3408 0000 50004-0200	718	99	79 3436 13 04	77 3634 0000 20004-0200	763	123
09 3442 828 05	76 2232 0111 00005-0200	713-763	131	79 3384 55 04	77 3408 0000 50004-0500	718	99	79 3436 15 04	77 3634 0000 20003-0500	763	123
09 3442 88 05	86 0132 0000 00005	713-763	133	79 3404 42 03	77 3608 0000 20003-0200	718	100	79 3436 17 04	77 3634 0000 20004-0500	763	123
09 3442 90 05	86 0532 1000 00005	713-763	133	79 3404 45 03	77 3608 0000 20003-0500	718	100	79 3436 32 04	77 3634 0000 50003-0200	763	123
09 3443 00 05	76 0931 0111 00005-0200	713-763	127	79 3404 52 03	77 3608 0000 50003-0200	718	100	79 3436 33 04	77 3634 0000 50004-0200	763	123
09 3448 00 04	76 0932 0111 00004-020										

## Compare list of change numbers of moulded M8/M12 cable connectors and M12 panel mount connectors with single wires

Number old	Number new	Series	Page	Number old	Number new	Series	Page	Number old	Number new	Series	Page
79 3436 52 04	77 3834 0000 50003-0200	763	123	79 3530 32 04	77 3530 0000 50703-0200	763	119	79 4454 20 05	77 4434 0000 50005-0200	766	161
79 3436 55 04	77 3834 0000 50003-0500	763	123	79 3530 33 04	77 3530 0000 50704-0200	763	119	79 4454 50 05	77 4434 0000 50005-0500	766	161
79 3439 12 05	77 3429 0000 20005-0200	763	111	79 3530 35 04	77 3530 0000 50703-0500	763	119	99 3431 216 04	86 0531 1002 00004	713-763	127
79 3439 15 05	77 3429 0000 20005-0500	763	111	79 3530 37 04	77 3530 0000 50704-0500	763	119	99 3441 216 05	86 0531 1002 00005	713-763	127
79 3439 32 05	77 3429 0000 50005-0200	763	111	79 3534 12 04	77 3534 0000 20703-0200	763	122	99 3481 216 08	86 0531 1002 00008	713-763	127
79 3439 35 05	77 3429 0000 50005-0500	763	111	79 3534 13 04	77 3534 0000 20704-0200	763	122	99 3481 77 08	86 0131 0002 00008	713-763	126
79 3439 52 05	77 3729 0000 50005-0200	763	111	79 3534 15 04	77 3534 0000 20703-0500	763	122	99 3482 77 08	86 0132 0002 00008	713-763	131
79 3439 55 05	77 3729 0000 50005-0500	763	111	79 3534 17 04	77 3534 0000 20704-0500	763	122				
79 3440 12 05	77 3430 0000 20005-0200	763	119	79 3534 32 04	77 3534 0000 50703-0200	763	122				
79 3440 15 05	77 3430 0000 20005-0500	763	119	79 3534 33 04	77 3534 0000 50704-0200	763	122				
79 3440 32 05	77 3430 0000 50005-0200	763	119	79 3534 35 04	77 3534 0000 50703-0500	763	122				
79 3440 35 05	77 3430 0000 50005-0500	763	119	79 3534 37 04	77 3534 0000 50704-0500	763	122				
79 3440 52 05	77 3730 0000 50005-0200	763	119	79 3539 12 05	77 3529 0000 20705-0200	763	111				
79 3440 55 05	77 3730 0000 50005-0500	763	119	79 3539 15 05	77 3529 0000 20705-0500	763	111				
79 3444 12 05	77 3434 0000 20005-0200	763	122	79 3539 32 05	77 3529 0000 50705-0200	763	111				
79 3444 15 05	77 3434 0000 20005-0500	763	122	79 3539 35 05	77 3529 0000 50705-0500	763	111				
79 3444 32 05	77 3434 0000 50005-0200	763	122	79 3540 12 05	77 3530 0000 20705-0200	763	119				
79 3444 35 05	77 3434 0000 50005-0500	763	122	79 3540 15 05	77 3530 0000 20705-0500	763	119				
79 3444 52 05	77 3734 0000 50005-0200	763	122	79 3540 32 05	77 3530 0000 50705-0200	763	119				
79 3444 55 05	77 3734 0000 50005-0500	763	122	79 3540 35 05	77 3530 0000 50705-0500	763	119				
79 3457 12 05	77 3427 0000 20005-0200	763	113	79 3544 12 05	77 3534 0000 20705-0200	763	122				
79 3457 15 05	77 3427 0000 20005-0500	763	113	79 3544 15 05	77 3534 0000 20705-0500	763	122				
79 3457 32 05	77 3427 0000 50005-0200	763	113	79 3544 32 05	77 3534 0000 50705-0200	763	122				
79 3457 35 05	77 3427 0000 50005-0500	763	113	79 3544 35 05	77 3534 0000 50705-0500	763	122				
79 3457 52 05	77 3727 0000 50005-0200	763	113	79 3557 12 05	77 3527 0000 20705-0200	763	113				
79 3457 55 05	77 3727 0000 50005-0500	763	113	79 3557 15 05	77 3527 0000 20705-0500	763	113				
79 3463 52 06	77 3403 0000 50006-0200	718	96	79 3577 32 08	77 3527 0000 50708-0200	763	113				
79 3463 55 06	77 3403 0000 50006-0500	718	96	79 3577 35 08	77 3527 0000 50708-0500	763	113				
79 3464 52 06	77 3406 0000 50006-0200	718	99	79 3579 32 08	77 3529 0000 50708-0200	763	111				
79 3464 55 06	77 3406 0000 50006-0500	718	99	79 3579 35 08	77 3529 0000 50708-0500	763	111				
79 3465 52 06	77 3405 0000 50006-0200	718	96	79 3580 32 08	77 3530 0000 50708-0200	763	119				
79 3465 55 06	77 3405 0000 50006-0500	718	96	79 3580 35 08	77 3530 0000 50708-0500	763	119				
79 3468 52 06	77 3408 0000 50006-0200	718	99	79 3584 32 08	77 3534 0000 50708-0200	763	122				
79 3468 55 06	77 3408 0000 50006-0500	718	99	79 3584 35 08	77 3534 0000 50708-0500	763	122				
79 3480 32 08	77 3430 0000 50608-0200	763	119	79 3803 52 08	77 3403 0000 50008-0200	718	96				
79 3480 35 08	77 3430 0000 50608-0500	763	119	79 3803 55 08	77 3403 0000 50008-0500	718	96				
79 3484 32 08	77 3434 0000 50608-0200	763	122	79 3805 52 08	77 3405 0000 50008-0200	718	96				
79 3484 35 08	77 3434 0000 50608-0500	763	122	79 3805 55 08	77 3405 0000 50008-0500	718	96				
79 3490 32 12	77 3430 0000 50712-0200	763	119	79 3806 52 08	77 3408 0000 50008-0200	718	99				
79 3490 35 12	77 3430 0000 50712-0500	763	119	79 3806 55 08	77 3408 0000 50008-0500	718	99				
79 3506 52 03	77 3506 0000 50003-0200	718	99	79 3808 52 08	77 3406 0000 50008-0200	718	99				
79 3506 55 03	77 3506 0000 50003-0500	718	99	79 3808 55 08	77 3406 0000 50008-0500	718	99				
79 3508 52 03	77 3508 0000 50003-0200	718	100	79 4347 20 05	77 4427 0000 50003-0200	766	160				
79 3508 55 03	77 3508 0000 50003-0500	718	100	79 4347 50 05	77 4427 0000 50003-0500	766	160				
79 3527 12 04	77 3527 0000 20703-0200	763	113	79 4349 20 05	77 4429 0000 50003-0200	766	160				
79 3527 13 04	77 3527 0000 20704-0200	763	113	79 4349 50 05	77 4429 0000 50003-0500	766	160				
79 3527 15 04	77 3527 0000 20703-0500	763	113	79 4350 20 05	77 4430 0000 50003-0200	766	161				
79 3527 17 04	77 3527 0000 20704-0500	763	113	79 4350 50 05	77 4430 0000 50003-0500	766	161				
79 3527 32 04	77 3527 0000 50703-0200	763	113	79 4354 20 05	77 4434 0000 50003-0200	766	161				
79 3527 33 04	77 3527 0000 50704-0200	763	113	79 4354 50 05	77 4434 0000 50003-0500	766	161				
79 3527 35 04	77 3527 0000 50703-0500	763	113	79 4427 20 04	77 4427 0000 50004-0200	766	160				
79 3527 37 04	77 3527 0000 50704-0500	763	113	79 4427 50 04	77 4427 0000 50004-0500	766	160				
79 3529 12 04	77 3529 0000 20703-0200	763	111	79 4429 20 04	77 4429 0000 50004-0200	766	160				
79 3529 13 04	77 3529 0000 20704-0200	763	111	79 4429 50 04	77 4429 0000 50004-0500	766	160				
79 3529 15 04	77 3529 0000 20703-0500	763	111	79 4430 20 04	77 4430 0000 50004-0200	766	161				
79 3529 17 04	77 3529 0000 20704-0500	763	111	79 4430 50 04	77 4430 0000 50004-0500	766	161				
79 3529 32 04	77 3529 0000 50703-0200	763	111	79 4434 20 04	77 4434 0000 50004-0200	766	161				
79 3529 33 04	77 3529 0000 50704-0200	763	111	79 4434 50 04	77 4434 0000 50004-0500	766	161				
79 3529 35 04	77 3529 0000 50703-0500	763	111	79 4447 20 05	77 4427 0000 50005-0200	766	160				
79 3529 37 04	77 3529 0000 50704-0500	763	111	79 4447 50 05	77 4427 0000 50005-0500	766	160				
79 3530 12 04	77 3530 0000 20703-0200	763	119	79 4449 20 05	77 4429 0000 50005-0200	766	160				
79 3530 13 04	77 3530 0000 20704-0200	763	119	79 4449 50 05	77 4429 0000 50005-0500	766	160				
79 3530 15 04	77 3530 0000 20703-0500	763	119	79 4450 20 05	77 4430 0000 50005-0200	766	161				
79 3530 17 04	77 3530 0000 20704-0500	763	119	79 4450 50 05	77 4430 0000 50005-0500	766	161				

# Technical information

## Important user information

- Binding for the applications of connectors are the requirements of the equipment specifications of the users.
- We reserve the right to change the design due to improvements in quality, further development or production requirements.
- All technical data mentioned in this catalogue are related to connectors, meaning connecting devices which in normal use (when under load) shall not be inserted or withdrawn.
- Regarding the CE marking it has to be noted that electronic components such as connectors are not subject to a marking, and therefore must not be marked with a CE-mark. This is confirmed by the rules of the European commission for low voltage and EMC guidelines.
- The listed technical data are intended to help selecting the appropriate product and to secure a proper application. The data are used to describe the product, however, certain properties are not guaranteed.
- The connectors are developed and designed for the use in the field of equipment, control and electrical appliances. Whether they also can be used in other applications has to be checked by the user.
- When mounting electrical conductive socket housings, they have to be integrated into the protection measures.
- The wires to be connected shall be stripped only so far that distances to conductive parts are not shortened. When wires are soldered, it has to be beared in mind that no single strands stick out and no short circuit can occur.
- All dimensions in this catalogue are in millimeters (mm).
- For connectors with strain relief the following minimum parameters are valid:

				Recommended tightening torque of the pressing screw
2 - 3	cable Ø:	min.	20 N	30 - 40 cNm
3 - 4	cable Ø:	min.	30 N	30 - 40 cNm
4 - 5	cable Ø:	min.	40 N	80 - 100 cNm
5 - 6	cable Ø:	min.	50 N	80 - 100 cNm
6 - 7	cable Ø:	min.	60 N	80 - 100 cNm
7 - 8	cable Ø:	min.	70 N	80 - 100 cNm
8 - 12	cable Ø:	min.	80 N	100 - 140 cNm
12 - 14	cable Ø:	min.	120 N	100 - 140 cNm

## General user information

### Connectors

Connectors are components which are not to be engaged or disengaged in normal use (under live).

### Plug and socket devices

Plug and socket devices are components which in normal use (under live or load) may be engaged or disengaged when live or under load.

### Termination methods

#### Screw connection

A screw connection is a detachable electrical connection between a conductor and a screw clamp. Screw clamps are designed acc. to DIN EN 60999-1/VDE 0609-1. The chart below shows the screw size and the required clamping and testing torque.

Screw size		M2,5	M3	M3,5
Torque (cNm)	Cap screw	40	50	60
	Headless screw	20	25	40

#### Solder connection

Besides the soldering of single wires with solder irons or soldering machines, the method of wave soldering or infra-red vapor phase soldering has gained great importance for connectors for printed boards or flexible wiring.

#### We recommend the following soldering parameters

- hand-soldering: soldering bold temperature max. 370 °C/max. 4s
- dip soldering: soldering bath temperature max. 270 °C/max. 4s
- alternativ dip soldering: soldering bath temperature max. 260 °C/max. 10s

When wires are soldered, it has to be watched that no single strands stick out which could lead to a short circuit and that no large solder joints occur which would reduce the clearance and creepage distances unfavourably. Testing and valuation of solder joints and the relevant components is regulated in IEC 60068-2.

#### Crimp connection

A crimp connection is a non-detachable electrical connection between a conductor and a crimp contact produced with the crimp technology. The requirements for crimp connections are defined in IEC 60352-2. An important point for the quality of a crimp connection is the achieved tensile strength of the termination. Since easy to measure, the tensile strength is a practicable means for quality control purposes.

# Technical information

## General user information

### Degree of protection (IP-Code)

For safety reasons, connectors have to be protected from outside influences like dust, foreign objects, direct contact, moisture and water. This protection is provided on industrial connectors by their housings with their latching devices and sealed cable entries. The degree of protection can be selected depending on the type of intended use. The standard IEC 60529 has specified and divided the degree of protection into several classes.

The degree of protection is indicated in the following way:

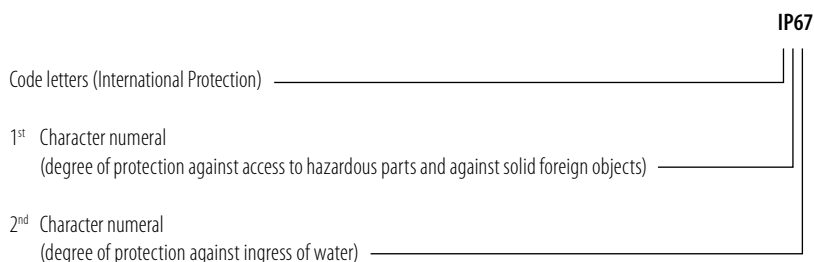

The following charts give an overview about all protection degrees.

1 <sup>st</sup> Char. No.	Definition	Remark	2 <sup>nd</sup> Char. No.	Definition	Remark
0	Not protected		0	Not protected	
1	Protected against access to hazardous parts with the back of a hand. Protected against solid foreign objects of $\varnothing \geq 50$ mm		1	Protected against water drops	
2	Protected against access to hazardous parts with a finger. Protected against solid foreign objects of $\varnothing \geq 12,5$ mm		2	Protected against water drops when enclosure tilted up to 15°	
3	Protected against access to hazardous parts with a tool. Protected against solid foreign objects $\varnothing \geq 2,5$ mm		3	Protected against spraying water	Water sprayed at an angle up to 60° on either side of the vertical shall have no harmful effects
4	Protected against access to hazardous parts with a wire. Protected against solid foreign objects $\varnothing \geq 1$ mm		4	Protected against splashing water	Water splashed against the disclosure from any direction shall have no harmful effects
5	Protected against access to hazardous parts with a wire. Dust-protected	Intrusion of dust is not totally prevented, but dust shall not penetrate in a quantity to interfere with satisfactory operation of the device or to impair safety	5	Protected against water jets	
6	Protected against access to hazardous parts with a wire. Dust-tight	No intrusion of dust	6	Protected against powerful water jets	
			7	Protected against the effects of temporary immersion in water	Intrusion of water in quantities causing harmful effects shall not be possible when the enclosure is temporarily immersed in water for 30 min. in 1 m depth
			8 <sup>1)</sup>	Protected against the effects of continuous immersion in water	Intrusion of water in quantities causing harmful effects shall not be possible when the enclosure is continuously immersed in water under conditions which shall be agreed between manufacturer and user but which are more severe than for numeral 7
			9K <sup>2)</sup>	Protected against water during high pressure/stream cleaning	A strong water jet splashed with high pressure and high temperature against the disclosure from any direction shall have no harmful effects. Test conditions: 100 bar water pressure, 80 °C water temperature, water delivery rate 15 l/min., distance to housing 10 cm, test-duration 30 sec. per position, (angle 0°, 30°, 60°, 90°) on a rotating table turning at 5 revolutions per minute

# Technical information

## Electrotechnical information

### Current carrying capacity

- The current carrying capacity of a connector denotes the current that can be carried continuously and simultaneously through all its contacts. It is determined by testing following the standard IEC 60512-5-2.
- The upper limit temperature results from the thermal properties of the contact and insulating materials. The sum of the ambient temperature and the temperature created by the current flow may not exceed the upper limit temperature of the connector.
- This means, that the current carrying capacity is no fixed value but decreases with increasing ambient temperatures. This relation between current, the caused temperature rise and ambient temperature of the connector is depicted in a curve, the so-called derating curve. As one can see, the current carrying capacity decreases with increasing ambient temperature.
- On the other hand, very often not all contacts are loaded simultaneously with the whole rated current, so that some single contacts can carry a higher current than that according to the derating curve. These currents have to be determined by testing.

### Derating curve

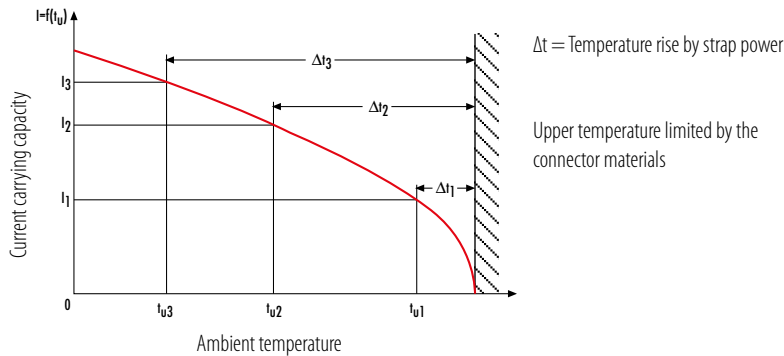

## General user information

### Shielding, electromagnetic compatibility (EMC)

Since the issue of the German law about electromagnetic compatibility of equipment, more attention is paid to EMC within the concerned equipment. The equipment has to be designed in such a way that

1. the generation of electromagnetic interference is limited to such extend that the determined operation of this equipment is not hampered,
  2. the equipment has a reasonable resistance against electromagnetic interference so that the determined operation is not hampered.
- To satisfy the requirements of the equipment manufacturers, more and more connectors with shielding properties are applied where shielded cables can be connected. In use are conductive housings to which the cable shield can be terminated.
  - In case of circular connectors, it should be watched that the cable shield is carefully connected to the connector shield. A circumferentially (360°) contact is optimal in this case. Good shielding values (and very often sufficient for practical use) are also achieved when the shielding braid is firmly connected to the conductive housing.
  - Not sufficient are fully plastic connectors without metal sleeves with no possibility to terminate the cable shield. Furthermore, it is important that during mating a secure electrical connection between plug and socket housing is achieved and that the panel mounted connector part has a good metallic connection with the chassis wall.
  - The shielding attenuation is stated in decibel (db) and depends on the frequency. Good shieldings have a high attenuation, which over a large frequency band (MHz) does not decrease too heavily.

### Information about used materials

Two material groups are used to manufacture the connectors described in this catalogue:

- Metals for contacts and housings
- Plastic material for inserts and housings

### Materials for contacts

The properties of contacts are defined to a large extent by the used materials. Decisive features are:

- strength and spring properties
- electrical conductivity
- max. operating temperature

Considering these points, binder is using proven copper-alloys for the manufacture of contacts; for pin contacts brass (CuZn), for socket contacts phosphor bronze (CuSn).

Brass combines good strength with good conductivity and temperature stability. Phosphor bronze offers next to a good conductivity very good spring capabilities and a high temperature performance.

### Materials for metal housings

Depending on the application, the metal housings are produced from either brass, zinc die-cast or an aluminium alloy. For circular housing parts, mainly brass is used due to its good machine ability and strength. For angled housings and parts with minor finishing work, zinc die-cast or an aluminium alloy is used.

### Plastic material for inserts

The inserts of binder-connectors are manufactured primarily from PBT (Polybutylenterephthalate), a plastic material with a temperature stability of up to 130 °C and special properties for high grade moulded parts. The material has very good chemical and electrical properties and very good dimensional stability.



# Technical information

## Information about used materials

### Surface finishes

In order to protect contacts and housings from aggressive environments and to improve the conductivity, the surfaces are treated accordingly. At binder, contacts are gold- or silver plated. These platings improve the conductivity and are very corrosion-proof. For applications in the mA-range at very low voltages, gold plated contacts are recommended to improve the electrical properties and in addition, it increases the corrosion-proofness. Housings are anodised or covered with a plating of either nickel or chromium for anti-corrosion and decorative reasons.

### Material for sealing gaskets

To achieve the required protection class, all binder circular connectors are equipped with sealing rings of an elastomeric material. Depending on the final use, binder has selected chloroprene rubber (Trademark Neoprene), nitrid rubber (Trademark Perbunan) or fluor-silicon rubber (Trademark Viton).

### Plastic material for housings

Plastic housings are primarily manufactured from PA (Polyamide). This well-proven material (internationally known under the name Nylon) is very tough, non-abrasive, resistant against solvents, oils and greases and can be used at temperatures up to 120 °C.

## Norms and test conditions

### Additional information to the technical data mentioned in this catalogue

Characteristics	Standard <sup>1)</sup>	Remark
Protection of housing	IEC 60529, ISO 20653 (IP69K)	Value in mated condition. Further information to IP-codes on <a href="http://www.binder-connector.com">www.binder-connector.com</a> <sup>2)</sup>
Mechanical operation	IEC 60512-9-1	Test is performed without electrical load.
Upper temperature	IEC 60512-6 (Test 11i)	Test condition is 168 hrs.
Lower temperature	IEC 60512-6 (Test 11j)	Test condition is 2 hrs.
Rated voltage	IEC 60664-1	The indicated value is defined under consideration of the pollution degree and the overvoltage category.
Rated impulse voltage	IEC 60664-1	Derived from overvoltage category and rated voltage.
Pollution degree	IEC 60664-1	Further information about pollution degrees on <a href="http://www.binder-connector.com">www.binder-connector.com</a> <sup>2)</sup>
Current carrying capacity	IEC 60512-5-2	Further information about current carrying capacity on <a href="http://www.binder-connector.com">www.binder-connector.com</a> <sup>2)</sup>
Rated current		Related to an ambient temperature of +40 °C (104 °F).
Contact resistance	IEC 60512-2-1	Resistance between contact pin and contact socket in mated condition over a defined length.

<sup>1)</sup> It has to be noted that all technical data represent initial values which may change after load.

## General user information

### American Wire Gauges

Since various areas of industry are also using wires according to the American Wire Gauge (AWG), the following comparison chart is included to allow a cross reference between AWG and metric wire sizes (mm<sup>2</sup>).

It has to be noted that wires of the same AWG number but with different composition have slightly different mm<sup>2</sup>!

AWG	Wire composition (mm)	Wire - Ø (mm)	Wire gauge (mm <sup>2</sup> )
30	1 x 0,25	0,25	0,05
	7 x 0,10	0,36	0,06
28	1 x 0,32	0,32	0,08
	7 x 0,13	0,38	0,09
26	1 x 0,40	0,40	0,13
	7 x 0,16	0,48	0,14
	19 x 0,10	0,51	0,15
24	1 x 0,51	0,51	0,21
	7 x 0,20	0,61	0,22
	19 x 0,13	0,64	0,25
22	1 x 0,51	0,64	0,33
	7 x 0,20	0,76	0,34
	19 x 0,13	0,81	0,38
20	1 x 0,81	0,81	0,52
	7 x 0,32	0,97	0,56
	19 x 0,20	1,02	0,60
18	1 x 1,02	1,02	0,82
	19 x 0,25	1,27	0,93
16	19 x 0,29	1,44	1,25
14	19 x 0,36	1,80	1,93
12	19 x 0,46	2,29	3,16
10	19 x 0,40	3,10	4,65

<sup>2)</sup> More information about the mentioned standards on [www.binder-connector.com/download-center/technical-information](http://www.binder-connector.com/download-center/technical-information)



# CIRCULAR CONNECTORS OF THE SPECIALIST



**Franz Binder GmbH & Co.  
Elektrische Bauelemente KG**

Rötelstraße 27  
74172 Neckarsulm  
Germany

Tel. +49 7132 325-0  
Fax +49 7132 325-190

[vk@binder-connector.de](mailto:vk@binder-connector.de)  
[www.binder-connector.de](http://www.binder-connector.de)

